

Project Submittal Package

Project:

Location:

Architect:

General Contractor:

Applicator:



Master Wall Inc.®

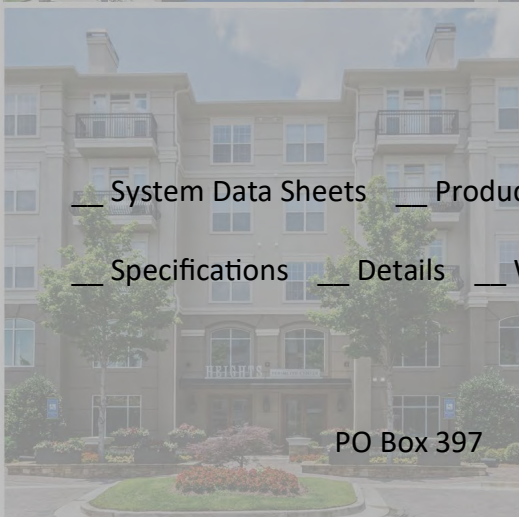

[System Data Sheets](#) [Product Data Sheets](#) [Sample Warranty](#)
[Specifications](#) [Details](#) [Web Link \(click here\)](#)

PO Box 397

Fortson

GA

31808

800-755-0825

masterwall.com

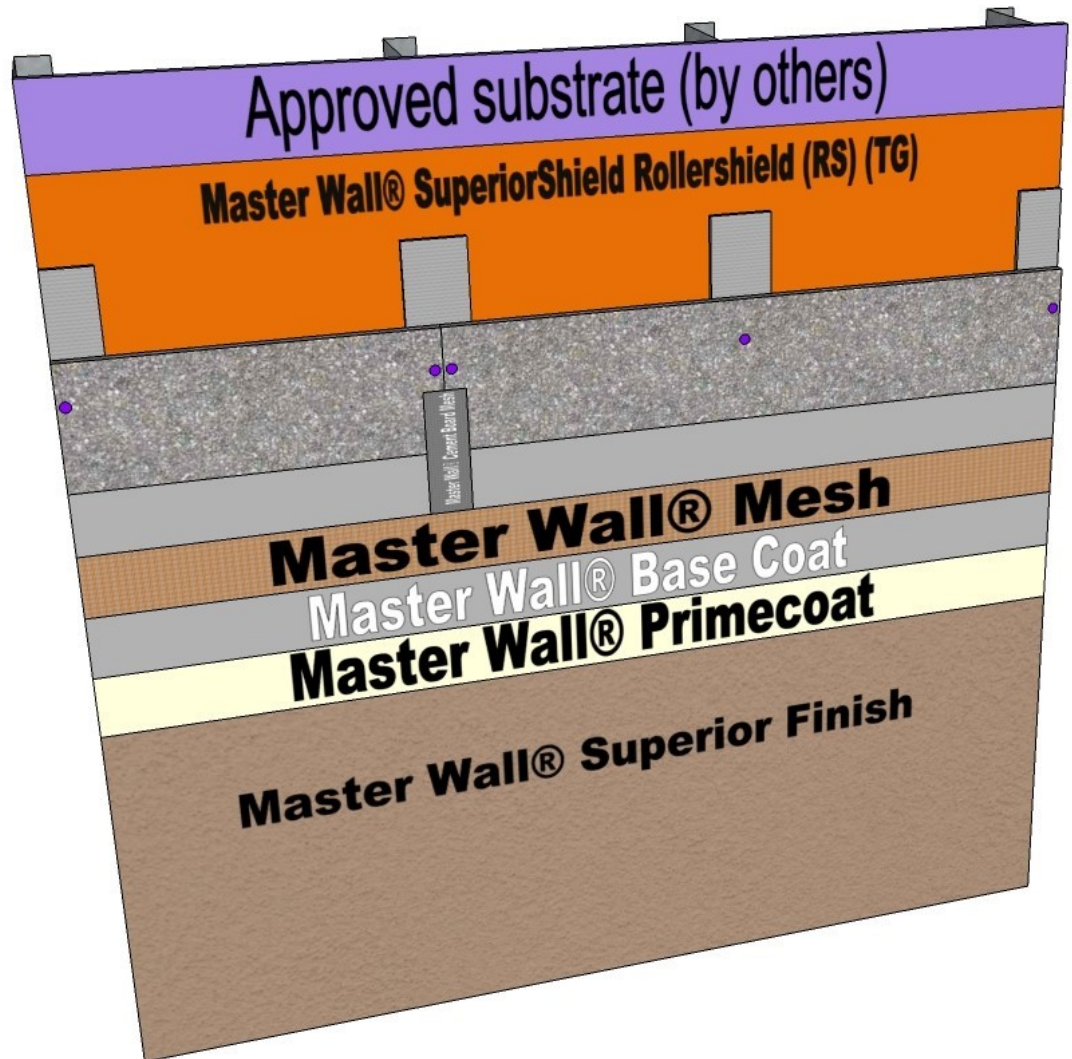

Features & Benefits

- Ultimate direct applied exterior finish system
- Applied over durable cement board or insulated cement board
- Complete solution, Rollershield LAB warranted with the system
- Keene® Space Assurance™ at framing members keeps the wall dry with a capillary break
- Durable Master Wall® coating products
- Primecoat Primer brightens the finish and improves aesthetics
- 12-year standard limited warranty - Includes water barrier and coatings

Information contained in this product data sheet conforms to the standard detail recommendations and specifications for the installation of Master Wall Inc.® products and is presented in good faith. Master Wall Inc.® assumes no liability, expressed or implied as to the architecture, engineering, or workmanship of any project. This information may be concurrent with, or superseded by other applicable documents, such as specifications and details. Contact Master Wall Inc.® for the most current product information. ©2023 Master Wall Inc.®



masterwall.com

Master Wall Inc.®



BUILDING PROTECTION SOLUTIONS



The Master Wall Inc.® SuperiorShield Building Solutions are your one-stop shop for air and water protection for your buildings. Our products are designed to work seamlessly with one another as part of a comprehensive air and water protection strategy. These Fluid-Applied Air and Water Barrier systems offer extremely low air leakage ratings with excellent water holdout. The centerpiece of this application is our Rollershield fluid-applied product that easily covers 100% of the surface area for complete building protection.

When it comes to keeping your building dry, you want 100% protection, and you can't settle for less. Sheet water barriers have laps, gaps, and are secured with fasteners. Mechanical attachment requires puncturing the substrate hundreds or even thousands of times. At windows and doors, peel-and-stick flashings don't seal properly or lose bond over time. The SuperiorShield Air and Water Barrier System is a fluid-applied, secondary water barrier and flashing that offers 100% coverage with no laps, breaks, or holes. It seals the substrate and protects the building. Like people, buildings breathe and are continuously passing water vapors around depending upon interior and exterior conditions.

The critical advantages of SuperiorShield Building Solutions are:

- Monolithic: No laps, breaks or holes. This feature eliminates the risk of incidental moisture intrusion through laps or breaks.
- Continuous: Will not pull away due to wind or tearing which can cause exposure to moisture and air leakage.
- Adhesive-Attachment: No fasteners required. Fasteners can create breaks in non-fluid applied barriers and the substrate.
- Fire Testing: This system has been tested to meet the standards of the NFPA 285 Fire Test and can be used on fire-resistance-rated construction assemblies.
- Multi-functional: Products can be used as a barrier with Master Wall® EIFS, brick, siding, stucco, stone, and panels.



For use with multiple claddings and wall construction types

Claddings

EIFS



Stucco



Brick



Stone



Metal Wall Panels

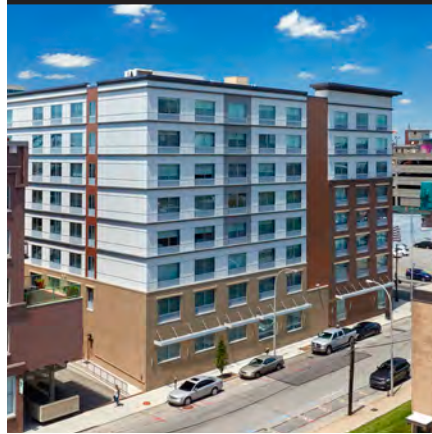

Siding

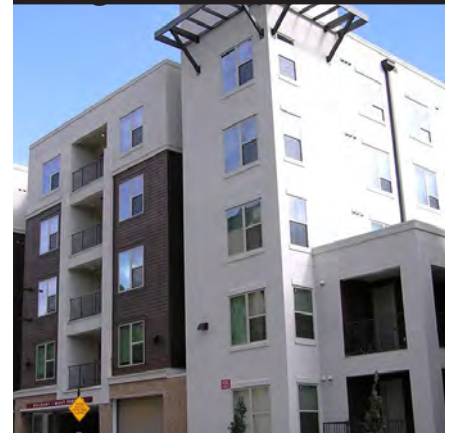

Wall Construction Types

Framed/Sheathed



CMU



ICF

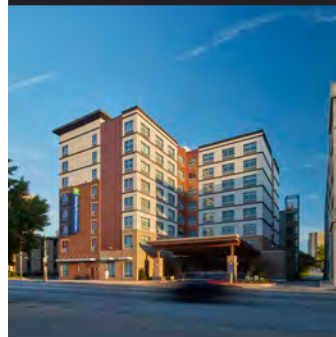

Precast



Master Wall® SuperiorShield Products



SuperiorShield Rollershield (RS)



Rollershield-RS is a high quality 100% acrylic flexible air and water barrier. Rollershield-RS is intended for roller or spray application but also can be troweled or brushed into place. Rollershield-RS forms a continuous air and water barrier that protects approved substrates from incidental water damage. Rollershield RS is Vapor Permeable and is used as a Water Barrier and a flashing material when used with RS Flashing Tape.

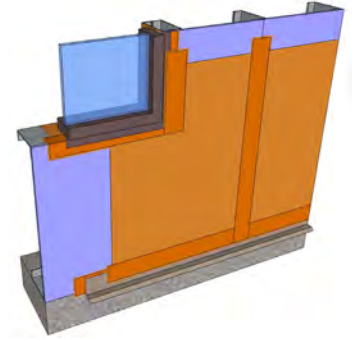

SuperiorShield Trowel Grade (TG)



Rollershield-TG is a high quality 100% acrylic flexible air and water barrier. Rollershield-TG is the trowel grade version of Rollershield RS and can be used for filling large gaps or leveling large areas in the Rollershield LAB system application. Rollershield-TG forms a continuous air and water barrier that protects approved substrates from incidental water damage. Rollershield TG is Vapor Permeable and is used as a Water Barrier and a flashing material when used with RS Flashing Tape.

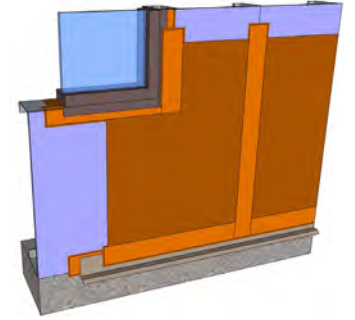

SuperiorShield Vapor Barrier (VB)

Rollershield-VB is the vapor barrier version of our Rollershield Liquid applied Air and Water Barrier (LAB). Rollershield-VB is a high quality roll applied flexible air and water barrier. Easily applied with a trowel, brush, roller, hopper gun or airless sprayer. Rollershield-VB forms a continuous air and water barrier that protects approved substrates from incidental water damage. Rollershield VB is a Vapor Blocker and is used as a Water Barrier and a flashing material when used with RS Flashing Tape.

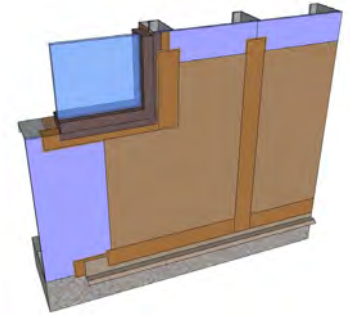

SuperiorShield Guardian A.M.B., Base Coat and Adhesive

To finish strong you need a Superior Base Coat that can not only protect but waterproof the surface. Premium Guardian is formulated with waterproof polymers and embeds easily into Master Wall mesh as part of a weather protection strategy. Guardian can be used as a below grade waterproofing agent as well as the initial barrier in CMU waterproofing applications above grade.

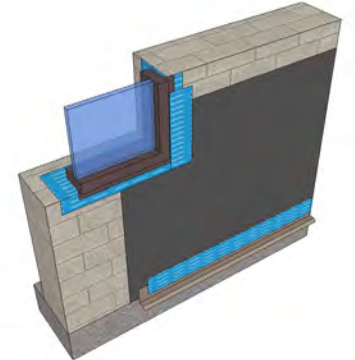

SuperiorShield WeatherSTOP

WeatherSTOP leveling base coat is formulated for superior weather resistance to stop water before it enters your stucco or wall. Flexible, fibered WeatherSTOP remains flexible, weather resistant and embeds easily into Master Wall® mesh. WeatherSTOP is an alternative to a separate fluid applied water barrier. WeatherSTOP blocks water before it soaks the stucco keeping your building dry. WeatherSTOP bridges minor hairline cracks, is flexible, levels the surface, and can be used as a base coat to create a smooth surface for finishing.

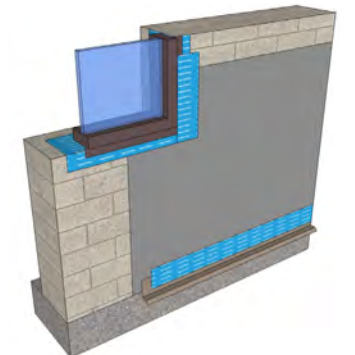

Master Wall® SuperiorShield Flashings and Accessories



SuperiorShield SuperiorFlash

Master Wall Inc.® SuperiorFlash is a gun-grade flashing and waterproofing. Formulated with STPE polymers, SuperiorFlash uses moisture curing to produce a highly durable, seamless, elastomeric flashing membrane. Fast curing, it allows for same day installation of windows, doors and other wall assembly, waterproofing or air barrier components. SuperiorFlash bonds directly to damp or dry surfaces and cures under a variety of weather conditions.

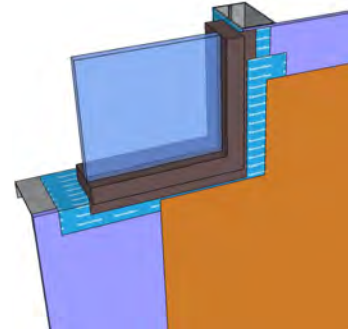

SuperiorShield Flashing Tape

Rollershield Flashing Tape is a lightweight roll flashing material with superior strength and the ability to bridge most gaps or voids common in construction. Embedded into wet Rollershield, it is used at flashing transitions with Master Wall® Rollershield air & water barrier applications. The tape easily embeds into wet Rollershield and dries to a highly reinforced yet flexible flashing.

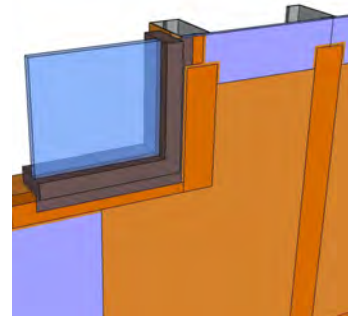

SuperiorShield Mesh

Master Wall Rollershield Mesh is a self-adhesive, lightweight, woven fiberglass mesh specially coated for compatibility with Master Wall Rollershield products. The self-adhesive properties allow easier application with Rollershield.

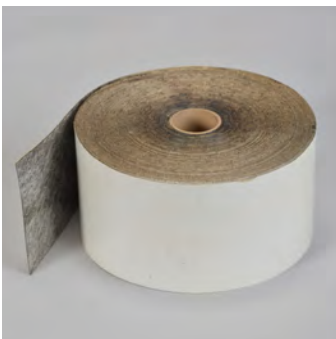
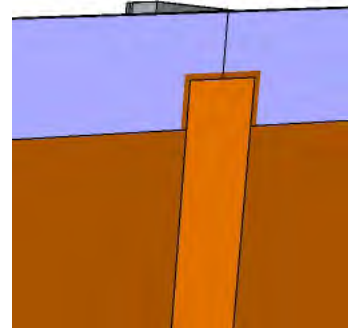

SuperiorShield WeatherSTOP Tape

WeatherStop Tapes are a peel and stick type flashing with self-sealing properties and a polyester scrim facing designed for use with Master Wall® Systems. The tapes feature low initial grab for repositioning that gradually increases over time.

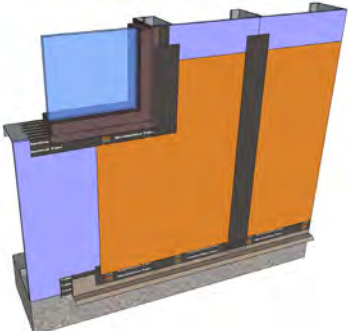

SuperiorShield Drainage Venting Roll

Master Wall DV Roll is a lightweight corrugated plastic designed for use where drainage or venting is required without the use of heavy plastic accessories. DV Roll can be used with back wrapped application techniques in Master Wall EIFS and as part of a compartmentalized venting assembly.



TEST	METHOD	CRITERIA	RESULT
Tensile Bond	ASTM C297/E2134, ICC ES (AC 212)* ICC ES (AC 212)*	Minimum 15 psi (104 kPa)	Dens Glass Gold 31 (215), Exterior Gypsum 28 (194), OSB 40 (277), Plywood 79 (563), Cement Board 70 (485), Copper 185 (1282), Galvanized steel 180 (1248), PVC 168 (1165), Aluminum 184 (1275), Coated Aluminum 203 (1407), Stainless Steel 183 (1269)
Freeze-Thaw	ASTM E2485/ICC-ES Proc. ICC ES (AC 212)*	No deleterious effects after 10 cycles	Pass: Plywood, Cement Board, OSB, Exterior Gypsum (ASTM C79/C1396) and Dens Glass Gold (ASTM C1377) substrates
Water Resistance	ASTM D2247 ICC ES (AC 212)*	No deleterious effects after 14 days exposure ¹	Pass: Plywood Cement Board, OSB, Exterior Gypsum (ASTM C79/C1396) and Dens Glass Gold (ASTM C1377) substrates
Water Vapor Transmission	ASTM E96 Proc. B ICC ES (AC 212)*	Vapor Permeable	30 perms (Rollershield RS) ² 12 perms (Rollershield TG) 0.007 perms (Rollershield VB)
Air Permeance	ASTM E2178	No ICC or ANS/EIMA Criteria ASHRAE/IECC max 0.04 cfm/ft ² @ 1.57 psf	0.001 cfm/ft ² @ 1.57 psf 0.001 L/s/m ² @ 75 Pa
Air Leakage	ASTM E2357	No ICC or ANS/EIMA Criteria ASHRAE/IECC max 0.04 cfm/ft ² @ 1.57 psf	0.0006 cfm/ft ² @ 1.57 psf 0.003 L/s/m ² @ 75 Pa 0.04 cfm/ft ² @ 6.24 psf 0.02 L/s/m ² @ 300 Pa
Structural Performance	ASTM E1233 Proc. A ICC ES (AC 212)*	Minimum 10 positive cycles at 1/240 deflection; No cracking in field, at joints or interface with flashing	Pass
Racking	ASTM E72 ICC ES (AC 212)*	No cracking in field, at joints or interface with flashing at net deflection of 3.2 mm (1/8 inch)	Pass
Restrained Environmental	ICC ES Procedure ICC ES (AC 212)*	5 cycles: No cracking in field, at joints or interface with flashing	Pass
Water Penetration	ASTM E331 ICC ES (AC 212)*	No water penetration beyond the inner-most plane of the wall after 15 minutes at 137 Pa (2.86 psf)	Pass
UV Exposure	ICC ES Proc. ICC ES (AC 212)*	210 hours of exposure	Pass
Accelerated Aging	ICC ES Proc. ICC ES (AC 212)*	25 cycles of wetting and drying	Pass
Hydrostatic Pressure Test	AATCC 127 ICC ES (AC 212)*	ICC: 549 mm (21.6 in) water column for 5 hours	Pass
Surface Burning Characteristics	ASTM E84	Flame Spread < 25 Smoke Developed < 450	Pass
Intermediate Multi-Story Fire Test	NFPA 285 (UBC 26-9)	No flame spread with up to 4" insulation	Pass
Nail Sealability	ASTM D1970	Standard Specification for Self-Adhering Polymer Modified Bituminous Sheet Materials Used as Steep Roofing Underlayment for Ice Dam Protection	Pass (22 mills)

* AC212 – Acceptance Criteria for Water-Resistive Coating Used as Water-Resistive Barriers over Exterior Sheathing, also referred to as ASTM E 2570

1. No cracking, checking, rusting, crazing, erosion, blistering, peeling or delamination when view under 5x magnification

2. Defined as a Class III vapor retarder per the 2015 IBC and IRCv

Master Wall[®] Mission

- To manufacture the highest-quality EIFS, stucco and related products (coatings, adhesives, etc.) available in the market.

- To be the service leader of our industry in the region and areas where we market our products.

- To be respected in our industry because of honesty and integrity within our ranks.

- To encourage our employees to set the highest standards possible for their careers and their personal lives by supporting them through education, training and sharing any God-given wisdom we may obtain.

- To compensate all employees in such a way that they can support themselves and their families in a comfortable manner.

- To seek God's guidance in all decisions, and to give Him glory for any results.

WE FINISH STRONG.



Corporate Office

P.O. Box 397
Fortson, GA 31808
800-755-0825
FAX 706-569-6704
Email: corporate@masterwall.com

Georgia Manufacturing

2265 Lithonia Industrial Boulevard
Lithonia, GA 30058
800-755-0824
FAX 770-482-9617

Utah Manufacturing

810 West Utah Avenue #1
Payson, UT 84651
888-492-0023
FAX 801-465-1129

Texas Manufacturing

979 Brazos Crossing Circle
Sealy, TX 77474
979-885-6905

Indiana Office

72-1/2 West Main Street
Suite #2
Danville, IN 46122
888-313-9966
FAX 317-745-0321

Technical Service

800-760-2861
tech@masterwall.com





Master Wall Inc.®
Building a Culture of Excellence

PRODUCT DATA

SUPERIORSHIELD ROLLERSHIELD-RS

SuperiorShield Rollershield-RS is a high quality 100% acrylic flexible fluid applied air and water barrier that is easily applied with a roller or spray equipment but also can be troweled or brushed into place. Rollershield-RS forms a continuous air and water barrier that protects approved substrates from incidental water damage.

FEATURES & BENEFITS

- Used as an air/water barrier in Rollershield LAB applications or as part of the Rollershield Drainage CIFS® System
- 100% Coverage, Fully adhered to substrate
- Vapor open/permeable with low air infiltration rate
- Used as water barrier and flashing, 60-minute Grade D equivalent
- Compatible with other SuperiorShield products; Rollershield-TG (Trowel Grade), Rollershield-VB, SuperiorFlash and WeatherSTOP Tape
- Adheres to most common building materials
- Easy to apply, water based for easy cleanup
- Exposure up to 6 months
- Low VOC, <1% by weight, 10 g/L

Application Temperature: 25° -110°F (-3.8° -43°C)

Dry to Touch: 1 hour @ room temperature

Recoat Time: 2 hours @ room temperature

Drying Time: 12 hours @ room temperature, working and drying time will vary with temperature and humidity.

JOB CONDITIONS

Air and substrate temperature for application of Rollershield-RS must be 40°F (5°C) or higher and must remain 40°F (5°C) or higher for a minimum of 24 hours unless special procedures are used. Provide temporary protection to protect the wall system from damage until permanent flashings, caps and sealants are installed. Store materials within prescribed temperature limits and out of direct sunlight. Working and drying times are based upon normal room temperature conditions and will vary with temperature and humidity.

PREPARATION

The substrate must be approved by Master Wall Inc.®, clean, dry, structurally sound, and free of efflorescence, oil, grease, form release agents and curing compounds or anything that would affect bond. Painted surfaces are not acceptable and must be removed or bond test performed. Substrates must be flat and free of fins or planar irregularities greater than 1/4" in 10'-0" (6.35 mm in 3.05 m).

Coverage per pail (sf/sm)*

Roller: 450-500 sf (42-46 sm)

Spray: 300-350 sf (28-32.5 sm)

Trowel: 200-250 sf (18-23 sm)

**All coverage is approximate for a single coat of 15 mils wet film thickness (WFT), 10 mils dry and depend upon substrate, details and individual application*

Packaging/Shelf Life/Storage

Packaging: 5 gallon (19L) pail

Product Color: Naranja Durazno

Shelf Life: 2 years

Storage: Protect from extreme heat: 90°F (32°C), freezing and direct sunlight.

APPLICATION PROCEDURE

Concrete – Must have cured a minimum of 28 days prior to the application of Rollershield-RS. If form release agents or curing compounds exist on the surface, they must be removed with a solution of muriatic acid or similar product (with appropriate precautions). Remove any residual acid by flushing with water.

Brick/Masonry – If joints are not struck flush, multiple coats may be required. Porous CMU may require additional coats.

Sheathing Applications - Sheathing gaps must be less than 1/4" (6.4 mm). See Technical Bulletin #189 for larger gap suggestions. Gap wood-based sheathing per manufacturers recommendations, typically 1/8" (3.2 mm) minimum.

Mixing - Thoroughly stir Rollershield-RS into a homogenous consistency. Do not add water, over mix, or add accelerators or retarders to the product.

Application – Rollershield-RS is applied by first treating the joints and fastener locations where sheathing is used, then coating the entire surface using brush, roller, trowel, or airless spray equipment techniques. When using a foam roller, a maximum 3/4" (19 mm) nap is recommended. Apply in an even, continuous coat, maintaining a wet edge of approximately 15 mils wet film thickness (WFT). Oriented Strand Board and other porous substrates will require two (2) coats of Rollershield-RS. For moisture protection, apply Rollershield-RS as a continuous barrier of 10 mils dry thickness with no breaks or skips, although some areas will appear lighter than others due to the application process. The application need not look like a painted surface.

Joint Treatment—Apply a thin layer of Rollershield-RS to the joints and embed SuperiorShield Flashing Tape into the wet mixture and trowel smooth. Alternatively place and center SuperiorShield Mesh over all joints, corners, and gaps in the substrate. Immediately apply Rollershield-RS over the mesh and allow to dry.

Rollershield-RS may be flashed into window, door and other openings using the same techniques for sheathing applications. Any remaining gaps should be filled with additional Rollershield-RS, TG (Trowel Grade) or SuperiorFlash.

Wall Treatment—Apply Rollershield-RS to the wall surface using the foam roller, trowel or by spray applying and backrolling to a uniform thickness of 15 mils WFT, 10 mils dry with no pinholes or voids.

Hazard: This chemical is not considered hazardous according to the OSHA Hazard Communication Standard 2012 (29 CFR 1910.1200).

Approved Substrates

Exterior gypsum sheathing (ASTM C1396)

Glass Fiber Exterior Sheathing (ASTM C1177): Dens Glass Gold®, GlasRoc®, FiberBond®, Gold Bond e2xp®, etc.

Cement Board Substrates (ASTM C1325): Durock®, PermaBase®, ProTEC®, SelectCrete, Util-A-Crete®, etc.

Concrete

Brick

Masonry

Exterior Plywood

Oriented Strand Board (OSB)

Huber Zip (See Data Sheet for Specifics)

Most metals and PVC

Others approved in writing

Compatible SuperiorShield Components

Rollershield-TG

SuperiorFlash

SuperiorShield Flashing Tape

SuperiorShield Mesh

WeatherSTOP Tape

Sealant Bond Compatibility**

Adfast Corp.: Adseal DWSP1940 Series***, Adseal 4600, Adseal 4580, Adseal 1940

Dow Corning: 795 Silicone**

Pecora Corp.: 864NST, 890NST, 890FTS, 895NST^A, Dynatrol I-XL Hybrid^B

Sika: Silaflex 15 LM***, Silaflex-2C NS***

Master Builders Solutions: MasterSeal NP1***

Tremco: Dymonic 100***

Most polyurethane sealants**

See Technical Bulletin MW#131 for latest sealant information

**field verify bond (varies)

***Also bonds to SuperiorFlash

^AWith P120 Primer with Rollershield RS & TG

^BWith P120 Primer with Rollershield VB

SPECIALTY APPLICATION - MEDIUM AND HIGH BUILD

Application for Medium-Build Specification: apply one or two coats to achieve minimum 20 mils wet film thickness (WFT). If applied by roller apply two coats to achieve minimum 20 mils WFT. For CMU substrates apply two or three coats to achieve 20-60 mils WFT.

Application for High-Build Specification: apply two or three coats to achieve 40 mils WFT. If applied by roller apply three or more coats as needed. For CMU substrates apply multiple coats to achieve 40-60 mils WFT.

IMPORTANT: the condition of the substrate may dictate thicker application or more coats to achieve a VOID and PINHOLE FREE SURFACE, particularly on substrates like concrete masonry where CMU composition, unit weight (lightweight or normal weight), porosity, joint profile, and other variables may exist. For “rough” CMU wall surfaces level with Master Wall Base Coat before applying the coating. Use the mock-up and site tests as the basis for the work. Some highly absorbent glass mat gypsum sheathing substrates may require back rolling to achieve a VOID and PINHOLE FREE surface. Avoid excess film build-up of wet material to prevent sag, especially on non-porous surfaces and during cold or damp weather. Work away from sun during application.

SPECIALTY APPLICATION - COLD WEATHER

Special Instruction for Cold Temperature Application: Master Wall Rollershield may be applied at temperatures less than 40° down to 25° F (4° down to -3.8°C), provided certain conditions are met:

1. Pre-condition Rollershield-RS to 65°-75° F (18°-24° C) for a minimum of 24 hours.
2. Confirm and maintain substrate and ambient temperatures are minimum 25° F (-3.8°C) and rising at the time of application and do not fall below 25° F (-3.8°C) until Rollershield-RS is fully dry.
3. Apply Rollershield-RS over standard sheathing substrates – glass mat gypsum, plywood, or OSB.
4. Confirm substrate surfaces are frost-free, dry and remain dry throughout the application and curing process.
5. Apply Rollershield-RS at a wet film thickness of no greater than 15 mils WFT.
6. Apply Rollershield-RS with Master Wall SuperiorShield Flashing Tape for joint and rough opening treatments.
7. Apply in dry weather and protected from rain or other precipitation for at least 24 hours and relative humidity (RH) remains at or below 50%. **IMPORTANT:** Final water-resistive barrier and air barrier material properties, and film toughness, depend on temperatures rising above freezing.

COLD WEATHER LIMITATIONS

Application range is at ambient temperatures between 25° and 100° F (-3.8° and 38° C) during application and drying period. Strictly adhere to Special Instructions for Cold Temperature Application if installing below 40° F (4° C).

Do not apply if substrate or ambient temperature is less than 25° F (-3.8°C), or if temperatures will go below 25° F (-3.8°C) at any time during the application or drying period.

Do not apply if the surface temperature is less than 5° F (2.8°C) above the ambient dew point temperature.

Technical Data

Solids Content: 69.52% solids by wt (55.05% by volume)

Tensile Bond, ASTM C297/E2134/AC212: 30-200 psi

Freeze-thaw ASTM E2485/AC212: Pass

Water Resistance, ASTM D2247/AC212: Pass

Water Vapor Transmission, ASTM E96 Proc. B/AC212: 30 perms** @ 10 mils, 15 perms @ 20 mils

Air Permeance, ASTM E2178: 0.001 cfm/ft² @ 1.57 psf, 0.001 L/s/m² @ 75 Pa

Air Leakage, ASTM E2357: 0.0006 cfm/ft² @ 1.57 psf (0.003 L/s/m² @ 75 Pa), 0.04 cfm/ft² @ 6.24 psf (0.02 L/s/m² @ 300 Pa)

Structural Performance, ASTM E1233/AC212: Pass

Racking, ASTM E72/AC212: Pass

Restrained Environmental, AC212: Pass

Water Penetration, ASTM E331/AC212: Pass

UV Exposure: Rated to 6 months

Accelerated Aging, AC212: Pass

Hydrostatic Pressure Test, AATCC 127/AC212: Pass

Surface Burning Characteristics, ASTM E84: Flame Spread < 25, Smoke Developed < 450

Intermediate Multi-Story Fire Test, NFPA 285 (UBC 26-9): Pass

Nail Sealability, ASTM D1970: Pass @ 22 mils

Heat and Smoke Release Rates, ASTM E1354, IBC Section 1403.5: Peak Heat Release Rate = 32 kW/m², Total Heat Release Rate = 3.6 MJ/m², Effective Heat of Combustion = 2.5 MJ/kg

** Defined as a Class III vapor retarder per IBC and IRC

LIMITATIONS

Not for use as an exterior finish, note exposure limitations on front page.

When adhering Rollershield Drainage CIFS® to the surface assure it is clean, dry, and free of surface contamination. Remove any dirt or surface contamination before adhesive attachment.

Allowable in-service temperature range: -40° to 180° F (-40° to 82° C).

Fire-retardant or pressure treated plywood must be dry with surface free of salts or other chemicals migrating from within the wood. Test adhesion to be sure of desired results.

Use a slip sheet, typically one layer of building paper between Rollershield-RS and stucco or adhered masonry veneer over metal lath.

SPRAY APPLICATION

Rollershield-RS is compatible with GRACO and Titan airless spray equipment with the following specifications:

- Minimum 1 gallon per minute output.
- Minimum hose width of 3/8 inch.
- Minimum tip size of 0.027–0.031.

Minimum pressure requirement to spray of 2,000 psi at the gun with an airless sprayer rated no lower than 3,300 psi. Remove all filters in sprayer and gun before application.

Hopper Gun: 3/16"-1/4" (6-6.5 mm) orifice, 23-25 psi.

CLEAN UP

Tools and equipment can be cleaned with soapy water when Rollershield-RS is wet.

Information contained in this product data sheet conforms to the standard detail recommendations and specifications for the installation of Master Wall Inc.® products and is presented in good faith. Master Wall Inc.® assumes no liability, expressed or implied as to the architecture, engineering, or workmanship of any project. This information may be concurrent with, or superseded by other applicable documents, such as specifications and details. Contact Master Wall Inc.® for the most current product information. ©2023 Master Wall Inc.®

Health & Safety

WARNING!

Causes eye and skin irritation.

Precautionary Statement

Wash hands thoroughly after handling. Wear protective gloves/protective clothing/eye protection/face protection.

FIRST AID MEASURES

Eye: Contact Rinse thoroughly with water as necessary. Get medical attention immediately if symptoms occur.

Skin: Contact Wash off with water. Consult a physician if necessary.

Inhalation: Move to fresh air. If symptoms arise, call a physician.

Ingestion: Clean mouth with water and afterwards drink plenty of water. Do NOT induce vomiting.

Consult a physician. Never give anything by mouth to an unconscious person.

Store locked up. Dispose of contents/container in accordance with Local, State, Federal and Provincial regulation.

Spills: Collect with suitable absorbent material such as cotton rags.

Disposal: Dispose of in accordance with local, state or federal regulations.

Warning: KEEP CONTAINER CLOSED WHEN NOT IN USE. KEEP OUT OF THE REACH OF CHILDREN. NOT FOR INTERNAL CONSUMPTION. FOR INDUSTRIAL USE ONLY.

Consult the Safety Data Sheet (SDS) in the Products section at masterwall.com for further health and safety information.

LIMITED WARRANTY

This product is subject to a written limited material or system warranty. Obtain a warranty from the Tech Support tab of our website. Refer to Specifications for more complete information on proper use and handling of this product.



Master Wall Inc.
Building a Culture of Excellence

PRODUCT DATA

SUPERIORSHIELD FLASHING TAPE

Lightweight non adhesive roll flashing material with superior strength and the ability to bridge most gaps or voids common in construction. Embedded into wet Rollershield-RS, TG or VB, it is used at flashing transitions with Master Wall® SuperiorShield Liquid Air/Water Barrier (LAB) and as part of Rollershield Drainage CIFS® applications. The tape easily embeds into wet Rollershield and dries to a highly reinforced yet flexible flashing.

FEATURES & BENEFITS

- Lightweight
- Strong
- Embeds easily
- Thin, will not build up wall surface
- Compatible with Rollershield RS, TG, VB and SuperiorFlash products

JOB CONDITIONS

Air and substrate temperature for application of SuperiorShield Flashing Tape must be 40°F (5°C) or higher. Follow Rollershield-RS, TG or VB temperatures and condition requirements.

PREPARATION

General—The substrate must be clean, dry, structurally sound, and free of efflorescence, oil, grease, form release agents and curing compounds. Test painted surfaces to verify bond.

Temporary Protection – Protect from weather until the Rollershield-RS, TG or VB products have set up.

Surface Preparation - Surface temperature must be above 40°F (5°C). Surface must be cured, clean, dry, structurally sound, and free of efflorescence, oil, grease, form release agents, and curing compounds.

Coverage estimate*

4x8 sheets: Square Footage x 0.37 = linear feet of tape

Add linear footage around windows, doors, and other openings.

**All coverage is approximate and depend upon substrate, details and individual application*

Roll Sizing/Packaging/Shelf Life/Storage

4"x180' (10.2cm x 54.9m)

6"x180' (15.2cm x 54.9m)

9"x180' (22.9cm x 54.9m)

Packaging:

4": 18 rolls per case.

6" & 9": 12 rolls per case.

Shelf Life: 2 years plus

Storage: Protect from extreme heat (90°F (32°C), and direct sunlight.

APPLICATION PROCEDURE

General - SuperiorShield Flashing Tape is embedded into wet Rollershield-RS, TG or VB at flashing transitions (sheathing to framing, flashing, penetrations, etc.) and at sheathing board joints. Apply a generous layer of the product using a trowel, brush or roller and immediately embed the SuperiorShield Flashing Tape into the product and draw it tight and smooth working from the center to the edges.

Windows – The unique properties of the SuperiorShield air/water barrier system allows window flashing prior to the Rollershield wall application. Apply Rollershield and center SuperiorFlash Flashing Tape to provide at least at least 1” (25 mm) bond to the window flange and substrate on either side of the window opening. Use a “butterfly” at corners to complete the application making sure it covers all corner joints. For best results make sure the Rollershield covers the entire head, jamb, and sill areas. The use of sill wedges or water stops is encouraged.

Sheathing Applications – Apply Rollershield at least 2” (51 mm) either side of the sheathing board joint. Immediately embed the SuperiorShield Flashing Tape into the wet Rollershield and smooth with a trowel, centering it over the joint. Provide at least at least 1” (25 mm) bond either side of the sheathing joint. Lap Rollershield Mesh Tape 2” (51 mm) minimum Rollershield field application can begin as soon as the Rollershield is dry to the touch.

Information contained in this product data sheet conforms to the standard detail recommendations and specifications for the installation of Master Wall Inc.® products and is presented in good faith. Master Wall Inc.® assumes no liability, expressed or implied as to the architecture, engineering, or workmanship of any project. This information may be concurrent with, or superseded by other applicable documents, such as specifications and details. Contact Master Wall Inc.® for the most current product information. ©2022 Master Wall Inc.®



Hazard: This chemical is not considered hazardous according to the OSHA Hazard Communication Standard 2012 (29 CFR 1910.1200).

VOC: Less than 50 g/L.

Approved Materials for Embedment

Rollershield-RS
Rollershield-TG
Rollershield-VB
Others approved in writing

LIMITED WARRANTY

This product is subject to a written limited material or system warranty. Obtain a warranty from the Tech Support tab of our website. Refer to Specifications for more complete information on proper use and handling of this product.

220701

Product Data

Space Assurance™

A Fastener Line for Ceiling Isolation

Description

Space Assurance™ is a flexible, flame-resistant polyester fabric used as a fastener line, ensuring the proper detail between the wall and ceiling.

Space Assurance eliminates a common path for noise flanking in multi-family construction.

Flanking noise is often caused by improper detailing of the gypsum wall and ceiling. The proper detail is to leave a 0.125" space and then caulk the joint. This installation detail is difficult to install and difficult to ensure.

The first step in ceiling installation is to install Space Assurance™ around the plate in each room prior to installing resilient channels. Ceiling elements butt against the Space Assurance™ with the bottom half used to separate the ceiling drywall from the wallboard. The excess is cut off.

Applications

- ✓ Multi-family construction: apartments and condominiums
- ✓ Wood frame construction or metal frame construction
- ✓ Gypsum board ceilings and walls
- ✓ Around every wall in wood and metal construction
- ✓ With one or two layers of gypsum board ceiling or wall

Features and Benefits

Proactively creates space between gypsum ceiling and walls

Eliminates caulking

Simple to inspect for proper spacing

Eliminates flanking paths for noise

Quick installation that saves time and money

Only UL-listed joint assembly with a gap

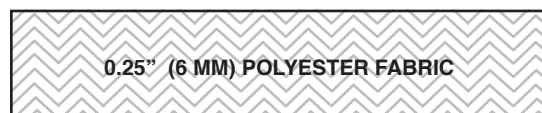

Physical Properties

Description	Means of Measurement English/Metric		Value English/Metric	
Core Polymer	Polypropylene			
Thickness	Inches	Mm	0.25	6.0
Total Weight	oz/yd ²	g/m ²	8.2	255

Packaging

Description	Means of Measurement English/Metric		Value English/Metric	
Core Width	Inches	CM	3.0	7.6
Length	Feet	Meters	100	30.4
Area	Square Feet	Square Meters	25.0	2.32
Roll Diameter	Inches	CM	24.0	61.0
Roll Weight	Pounds	Kg	2.1	9.5

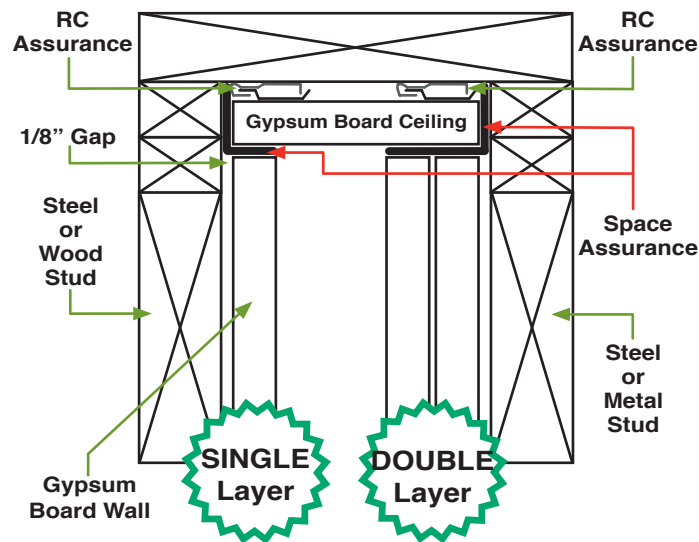

See installation instructions for methods and procedures.

LIMITED WARRANTY: Keene Building Products, Inc. warrants to the initial purchaser only that the goods sold hereunder will be free from defects in material and workmanship and, except as otherwise set forth herein, will conform to the specifications provided. If any failure to meet this warranty appears within one year from the date of shipment of the goods, on the condition that Keene Building Products, Inc. will correct any such failure by either replacing or repairing any defective goods, at Keene Building Products, Inc.'s option.

The preceding paragraph sets forth the exclusive remedy for all claims based on failure of or defect in the goods sold hereunder, whether such failure or defect arises before or during the warranty period and whether a claim, however instituted, is based on contract, indemnity, warranty, tort (including negligence), strict liability or otherwise. The forgoing warranty is exclusive and is in lieu of all other warranties whether written, oral, implied or statutory.

QUIET QURL is a component in an overall floor/ceiling assembly. Its performance is affected by every other component and the likelihood of achieving code compliance is contingent upon many other trades including framers, plumbers, drywall contractors to name a few. Developers and general contractors are responsible for building properly and testing field performance as soon as possible in order to assure the reliability of the project.

WARNING: Laboratory tests are not a guarantee of field performance because of the issues noted above and many other design errors that may occur. Please consult a professional acoustical consultant to assure plans are proper and that the floor/ceiling assembly can perform to expectations.



P.O. Box 241353

Mayfield Heights, OH 44124

Info@KeeneBuilding.com

www.KeeneBuilding.com

877 | 514 | 5336

P 440 | 605 | 1020

F 440 | 605 | 1120

2/2
2015/2



Cement Board Mesh

Lightweight Reinforcing Mesh

Approved Systems

Master Wall Stucco Cement Board Coatings

Mesh Properties

ASTM C474

ASTM C475

Weave: 8x8

Widths & Packaging

3" x 150' (76 mm x 45.7 m)

Coverage Estimate (4x8 sheets)

Square Footage x 0.37 = linear feet of mesh (coverage is not guaranteed)

Master Wall Cement Board Mesh is a self-adhesive lightweight woven, glass fiber mesh that is specially coated for compatibility with Master Wall Base Coats. The 3" (76 mm) wide mesh is used as the first reinforcing layer in the Stucco Cement Board Coating application.

Application Procedure

General—The substrate must be clean, dry, structurally sound and free of efflorescence, oil, grease, form release agents and curing compounds. Painted surfaces are not acceptable and the paint must be removed.

Job Conditions - Air and substrate temperature for application of the Cement Board Mesh must be 40°F (5°C) or higher and must remain 40°F (5°C) or higher for a minimum of 24 hours.

Temporary Protection – Must be provided at all times until the wall system, including flashings, caps, and sealants, is completed to provide protection from climatic conditions and other potential damage.

Installation – Apply Cement Board Mesh according to Master Wall Specifications. In general, Cement Board Mesh is centered on the cement board joints and corners before the first application of base coat at the joints. Alternatively the mesh can be embedded into wet base coat at these locations. See the Stucco Cement Board Coatings specifications and details for specific instructions. Lap Cement Board Mesh a minimum of 2-1/2" (63.5 mm).

Limitations

Cement Board Mesh is not intended for use as the exterior or primary reinforcement of any Master Wall System.

Information contained in this product data sheet conforms to the standard detail recommendations and specifications for the installation of Master Wall Inc.® products and is presented in good faith. Master Wall Inc.® assumes no liability, expressed or implied as to the architecture, engineering, or workmanship of any project. This information may be concurrent with, or superseded by other applicable documents, such as specifications and details. Contact Master Wall Inc.® for the most current product information. © 2016 Master Wall Inc.®



masterwall.com

PO Box 397 • Fortson • GA • 31808 • 800-755-0825 • Tech: 800-760-2861



Master Wall Inc.®
Building a Culture of Excellence

PRODUCT DATA

F&M ADHESIVE AND BASE COAT

Foam & Mesh Adhesive (F&M) is a 100% acrylic formulated high performance base coat and adhesive used in Master Wall® Systems or over prepared substrates including brick, masonry, concrete and stucco.

FEATURES & BENEFITS

- Adheres insulation board to approved substrates
- Base coat for Master Wall CIFS®, EIFS and other Systems
- Leveling coat for Cemplaster Fiberstucco and other stucco products
- Excellent water resistance
- Mixes 1:1 with Portland cement to a creamy consistency
- 100% Acrylic Polymers for durability
- Water-based - easy clean up with water

Application Temperature: 40°-110°F (5°-43°C)

Working Time: 1 hour

Set Time: Varies with temperature and humidity

Dry Time: 12 hours at room temperature, working and drying time will vary with temperature and humidity.

JOB CONDITIONS

Air and substrate temperature for application of F&M must be 40°F (5°C) or higher and must remain 40°F (5°C) or higher for a minimum of 24 hours. Provide temporary protection to protect the wall system from damage until permanent flashings, caps and sealants are installed. Store materials within prescribed temperature limits and out of direct sunlight. Working and drying times are based upon normal room temperature conditions and will vary with temperature and humidity.

PREPARATION

The substrate must be approved by Master Wall Inc.®, clean, dry, structurally sound and free of efflorescence, oil, grease, form release agents and curing compounds or anything that would affect bond. Painted surfaces are generally unacceptable without evaluation. Reference Technical Bulletins #173 and #187 for additional information.

Coverage per pail (sf/sm)*

Adhesive & Standard Base Coat:
120 sf (11 sm)

Embedding Single-layer of Mesh:
240-280 sf (22-26 sm)

Double Layer of Mesh:
80-230 sf (7.5-21 sm)

Notched Trowel Adhesive Application:
135 sf (12.5 sm)

**All coverage is approximate and depend upon substrate, details and individual application*

Packaging/Shelf Life/Storage

Packaging: 5 gallon (19L) pail

Pail Weight: 60 lbs (27 kg)

Shelf Life: 2 years

Storage: Protect from extreme heat - 90°F (32°C) and above, freezing and direct sunlight.

Technical Data

ASTM C297/E2134 - min 30 psi (208 kPa)

ASTM D897 - min 22 psi (152 kPa) ASTM
D2247 - Pass

ASTM E84 - Pass

ASTM E96 - 12 perms

ASTM E331 - Pass to 12.0 psf (575 Pa)

ASTM E2485/EIMA 101.01* - Pass NFPA
268* - Pass

NFPA 285 (UBC 26-9)* - Pass

*part of a larger assembly

APPLICATION PROCEDURE

Mixing - Thoroughly stir F&M using a heavy duty 1/2" (12.7 mm) drill at 400 to 500 rpm and a heavy duty mixing paddle. Pour half of the stirred F&M into a clean plastic pail. Add Type I or I-II Portland cement to the half pail of F&M in a ratio of one-to-one by weight and mix to a homogenous consistency. Let the mixture stand for 3 to 5 minutes and then stir to a creamy consistency. Up to 30 ounces (0.9L) of clean, potable water may be added to a half pail to adjust workability. Do not over mix as faster setting or reduced working time can occur. Do not add accelerators or retarders to the F&M mixture.

APPLICATION

ADHESIVE APPLICATION – Over gypsum or Rollershield coated substrates, apply the F&M mixture directly to the back of the insulation board using a 3/8" x 3/8" x 3/8" (9.5 x 9.5 x 9.5 mm) or a 3/8" x 1/2" x 1-1/2" (9.5 x 13 x 38 mm) stainless steel notched trowel. With the trowel at a 45-degree angle, cover the entire back of the insulation board with full beads of adhesive. Apply the adhesive so the ribbons run vertically when applied to the wall.

Over non-gypsum substrates where drainage is not required, you may use the above described notched trowel method or the 'ribbon and dab' method. Using a stainless steel plastering trowel, apply a 2" (50.8 mm) wide by 3/8" (9.5 mm) high ribbon of the F&M mixture around the entire perimeter of the insulation board. Place 8 dabs of the F&M mixture 3/8" (9.5 mm) thick by 4" (102 mm) in diameter approximately 8" (204 mm) on center inside the ribbon.

Immediately place the prepared insulation board on the substrate. Make sure that all edges of the insulation board are abutted tightly and that no F&M mixture gets into the board joints. Do not allow the F&M mixture to form a skin prior to placing the insulation board on the substrate. Do not apply the F&M mixture directly onto the substrate.

BASE COAT APPLICATION – Over insulation board, all imperfections in the board must be rasped flush and any gaps in the insulation board must be filled with slivers of insulation. Apply the F&M mixture over the entire surface of the insulation board in a thickness greater than that of the reinforcing fabric being used (approximately 1/16" (1.6 mm) for standard mesh and 3/32" (2.4 mm) for Ultra Mesh). Immediately embed the reinforcing fabric into the wet F&M mixture and smooth from the center to the edge to avoid wrinkles. The reinforcing fabric must be continuous at all corners and lapped or abutted in accordance with Master Wall® specifications. The color of the mesh shall not be visible, but a slight mesh pattern may be visible.

As a leveling coat over approved concrete, masonry, stucco, and other surfaces, apply the F&M mixture over the entire surface a nominal 1/16" (1.6 mm) thick. Where reinforcing mesh is specified, follow application methods for insulation board above.

Hazard: This chemical is not considered hazardous according to the OSHA Hazard Communication Standard 2012 (29 CFR 1910.1200).

VOC: Less than 50 g/L.

Approved Substrates

Exterior gypsum sheathing
(ASTM C1396, C1177)

Dens Glass Gold®
GlasRoc®
FiberBond®
Gold Bond e2xp®
Securock®
Weather Defense Platinum™

Cement Board (ASTM C1325)
Durock®
PermaBase®
Util-A-Crete®
ProTEC®, ProGUARD®

Concrete
Brick
Masonry
Metal Lath - Adhesive Application
Adheres to Rollershield
Others approved in writing

CLEAN UP

Tools and equipment can be cleaned with soapy water while the F&M is still wet.

WARNING, THIS PRODUCT CONTAINS SILICA

If sanding or scraping are performed, ventilate work area and/or use a NIOSH/MSHA-approved respirator in accordance with our Safety Data Sheet.

Information contained in this product data sheet conforms to the standard detail recommendations and specifications for the installation of Master Wall Inc.® products and is presented in good faith. Master Wall Inc.® assumes no liability, expressed or implied as to the architecture, engineering, or workmanship of any project. This information may be concurrent with, or superseded by other applicable documents, such as specifications and details. Contact Master Wall Inc.® for the most current product information. ©2022 Master Wall Inc.®



Health & Safety

WARNING!

Causes eye and skin irritation.
Precautionary Statement

Wash hands thoroughly after handling. Wear protective gloves/protective clothing/eye protection/face protection.

FIRST AID MEASURES

Eye Contact: Immediately flush eyes with plenty of water for at least 15 to 20 minutes. Ensure adequate flushing of the eyes by separating the eyelids with fingers. Get immediate medical attention.

Skin Contact: Immediately wash skin with plenty of soap and water for 15 to 20 minutes, while removing contaminated clothing and shoes. Get medical attention if irritation develops or persists.

Inhalation: If inhaled, remove to fresh air. If not breathing, give artificial respiration or give oxygen by trained personnel. Seek immediate medical attention.

Ingestion: If swallowed, do NOT induce vomiting. Call a physician or poison control center immediately. Never give anything by mouth to an unconscious person.

Store locked up. Dispose of contents/container in accordance with Local, State, Federal and Provincial regulation.

Spills: Collect with suitable absorbent material such as cotton rags.

Disposal: Dispose of in accordance with local, state or federal regulations.

Warning: KEEP CONTAINER CLOSED WHEN NOT IN USE. KEEP OUT OF THE REACH OF CHILDREN. NOT FOR INTERNAL CONSUMPTION. FOR INDUSTRIAL USE ONLY.

Consult the Safety Data Sheet (SDS) in the Products section at masterwall.com for further health and safety information.

LIMITED WARRANTY

This product is subject to a written limited material or system warranty. Obtain a warranty from the Tech Support tab of our website. Refer to Specifications for more complete information on proper use and handling of this product.



Master Wall Inc.
Building a Culture of Excellence

PRODUCT DATA

MBB

Master Wall® Bagged Base Coat (MBB) is a dry polymer acrylic formulated high performance base coat and adhesive used in Master Wall® Systems or over prepared substrates including brick, masonry, concrete and stucco.

FEATURES & BENEFITS

- Adheres insulation board to approved substrates
- Base coat for Master Wall CIFS®, EIFS and other Systems
- Leveling coat for Cemplaster Fiberstucco and other stucco products
- Excellent water resistance
- Freeze stable in dry form
- Convenient, mixes with water
- Easy clean up with water

Application Temperature: 40°-110°F (5°-43°C)

Working Time: 1 hour

Set Time: Varies with temperature and humidity

Dry Time: 12 hours at room temperature, working and drying time will vary with temperature and humidity.

JOB CONDITIONS

Air and substrate temperature for application of MBB must be 40°F (5°C) or higher and must remain 40°F (5°C) or higher for a minimum of 24 hours. Provide temporary protection to protect the wall system from damage until permanent flashings, caps and sealants are installed. Store materials within prescribed temperature limits and out of direct sunlight. Working and drying times are based upon normal room temperature conditions and will vary with temperature and humidity.

PREPARATION

The substrate must be approved by Master Wall Inc®, clean, dry, structurally sound and free of efflorescence, oil, grease, form release agents and curing compounds or anything that would affect bond. Painted surfaces are generally unacceptable without evaluation. Reference Technical Bulletins #173 and #187 for additional information.

Coverage per bag (sf/sm)*

Adhesive & Standard Base Coat:

50-60 sf (4.6-5.36 sm)

Embedding Single-layer of Mesh:

100-125 sf (9-11.5 sm)

Double Layer of Mesh:

30-110 sf (2.5-10 sm)

Notched Trowel Adhesive Application:

56 sf (5.2 sm)

**All coverage is approximate and depend upon substrate, details and individual application*

Packaging/Shelf Life/Storage

Packaging: 50lb (22.7kg) bag

Shelf Life: 1 year

Storage: Protect from weather, high humidity and direct sunlight.

Technical Data

ASTM C297/E2134 - min 30 psi (208 kPa)

ASTM E96 - 12 perms

APPLICATION PROCEDURE

Mixing - Add 5 to 6 quarts (4.7-5.7L) of potable water to a clean plastic pail. Add the MBB slowly while stirring using a heavy-duty 1/2" (12.7mm) drill at 400 to 500 rpm and a heavy-duty Mixer. Mix thoroughly to a homogenous consistency. Let the mixture stand for 3 to 5 minutes and then stir to a creamy consistency. Small amounts of clean, potable water may be added to obtain a workable consistency. Do not over mix. Excessive stirring may cause faster setting and reduced working time. Do not add accelerators or retarders to the MBB mixture.

APPLICATION

ADHESIVE APPLICATION - Over gypsum or Rollershield coated substrates, apply the MBB mixture directly to the back of the insulation board using a 3/8" x 3/8" x 3/8" (9.5 x 9.5 x 9.5 mm) or a 3/8" x 1/2" x 1-1/2" (9.5 x 13 x 38 mm) stainless steel notched trowel. With the trowel at a 45-degree angle, cover the entire back of the insulation board with full beads of adhesive. Apply the adhesive so the ribbons run vertically when applied to the wall.

Over non-gypsum substrates where drainage is not required, you may use the above described notched trowel method or the 'ribbon and dab' method. Using a stainless steel plastering trowel, apply a 2" (50.8 mm) wide by 3/8" (9.5 mm) high ribbon of the F&M mixture around the entire perimeter of the insulation board. Place 8 dabs of the F&M mixture 3/8" (9.5 mm) thick by 4" (102 mm) in diameter approximately 8" (204 mm) on center inside the ribbon.

Immediately place the prepared insulation board on the substrate. Make sure that all edges of the insulation board are abutted tightly and that no F&M mixture gets into the board joints. Do not allow the MBB mixture to form a skin prior to placing the insulation board on the substrate. Do not apply the MBB mixture directly onto the substrate.

BASE COAT APPLICATION - Over insulation board, all imperfections in the board must be rasped flush and any gaps in the insulation board must be filled with slivers of insulation. Apply the MBB mixture over the entire surface of the insulation board in a thickness greater than that of the reinforcing fabric being used (approximately 1/16" (1.6 mm) for standard mesh and 3/32" (2.4 mm) for Ultra Mesh). Immediately embed the reinforcing fabric into the wet MBB mixture and smooth from the center to the edge to avoid wrinkles. The reinforcing fabric must be continuous at all corners and lapped or abutted in accordance with Master Wall® specifications. The color of the mesh shall not be visible, but a slight mesh pattern may be visible.

As a leveling coat over approved concrete, masonry, stucco, and other surfaces, apply the MBB mixture over the entire surface a nominal 1/16" (1.6 mm) thick. Where reinforcing mesh is specified, follow application methods for insulation board above.

Hazard: This chemical is not considered hazardous according to the OSHA Hazard Communication Standard 2012 (29 CFR 1910.1200).

VOC: Less than 50 g/L.

Approved Substrates

Exterior gypsum sheathing
(ASTM C1396, C1177)

Dens Glass Gold®

GlasRoc®

FiberBond®

Gold Bond e2xp®

Securock®

Weather Defense Platinum™
Cement Board (ASTM C1325)

Durock®

PermaBase®

Util-A-Crete®

ProTEC®, ProGUARD®

Concrete

Brick

Masonry

Metal Lath - Adhesive Application

Adheres to Rollershield

Others approved in writing

CLEAN UP

Tools and equipment can be cleaned with soapy water while the MBB is still wet.

WARNING, THIS PRODUCT CONTAINS SILICA

If sanding or scraping are performed, ventilate work area and/or use a NIOSH/MSHA-approved respirator in accordance with our Safety Data Sheet.

Information contained in this product data sheet conforms to the standard detail recommendations and specifications for the installation of Master Wall Inc.® products and is presented in good faith. Master Wall Inc.® assumes no liability, expressed or implied as to the architecture, engineering, or workmanship of any project. This information may be concurrent with, or superseded by other applicable documents, such as specifications and details. Contact Master Wall Inc.® for the most current product information. ©2022 Master Wall Inc.®



Health & Safety

WARNING!

Causes eye and skin irritation.
Precautionary Statement

Wash hands thoroughly after handling. Wear protective gloves/protective clothing/eye protection/face protection.

FIRST AID MEASURES

Eye Contact: Immediately flush eyes with plenty of water for at least 15 to 20 minutes. Ensure adequate flushing of the eyes by separating the eyelids with fingers. Get immediate medical attention.

Skin Contact: Immediately wash skin with plenty of soap and water for 15 to 20 minutes, while removing contaminated clothing and shoes. Get medical attention if irritation develops or persists.

Inhalation: If inhaled, remove to fresh air. If not breathing, give artificial respiration or give oxygen by trained personnel. Seek immediate medical attention.

Ingestion: If swallowed, do NOT induce vomiting. Call a physician or poison control center immediately. Never give anything by mouth to an unconscious person.

Storage: Store locked up. Dispose of contents/container in accordance with Local, State, Federal and Provincial regulation.

Spills: Collect with suitable absorbent material such as cotton rags.

Disposal: Dispose of in accordance with local, state or federal regulations.

Warning: KEEP CONTAINER CLOSED WHEN NOT IN USE. KEEP OUT OF THE REACH OF CHILDREN. NOT FOR INTERNAL CONSUMPTION. FOR INDUSTRIAL USE ONLY.

Consult the Safety Data Sheet (SDS) in the Products section at masterwall.com for further health and safety information.

LIMITED WARRANTY

This product is subject to a written limited material or system warranty. Obtain a warranty from the Tech Support tab of our website. Refer to Specifications for more complete information on proper use and handling of this product.



Master Wall Inc.®
Building a Culture of Excellence

PRODUCT DATA

AGGRE-FLEX MESH

Master Wall® Aggre-flex Mesh is a specially woven, glass fiber mesh with AR Coating (Alkali Resistive). Embedded in Master Wall® base coats, Aggre-flex Mesh is the key impact and tensile component in Master Wall® EIFS and wall systems. It can also improve crack resistance in Master Wall® Cemplaster Fiberstucco Systems, traditional stucco or foam shapes.

FEATURES & BENEFITS

- **Detail Mesh** – super soft, pliable mesh used for backwrapping, special shapes, and detail work.
- **Standard Mesh**–Standard weight mesh for wall areas and general detailing. Industry leading impact resistance.
- **Hi-Tech Mesh**–Upgraded heavier weight version of Standard Mesh with good workability.
- **Medium Mesh**–Extra tough heavy weight mesh. Best for areas of light traffic.
- **Strong Mesh**–Great high traffic mesh where impacts are a consideration.
- **Ultra Mesh**–Best where abuse is expected. Ultra heavy for high traffic areas.
 - **Strong Mesh and Ultra Mesh** must be used in a two-layer system.
- **Corner Roll**– For highly impact resistant corners. Apply under Standard or higher mesh.

MESH WEIGHT AND COVERAGE

	Mesh Weight	Roll Size	Coverage*
Detail	4.5 oz/sy (113 g/sm)	9.5" x 150' (96.5cm x 45.7m)	119 sf (11 sm)
Standard - 38	4.6 oz/sy (156 g/sm)	38" x 150' (96.5cm x 45.7m)	475 sf (44.1 sm)
Standard - 48	4.6 oz/sy (156 g/sm)	48" x 150' (122 cm x 45.7m)	600 sf (55.7 sm)
Hi-Tech	6.0 oz/sy (202 g/sm)	48" x 150' (122cm x 45.7m)	600 sf (55.7sm)
Medium	11.0 oz/sy (370 g/sm)	38" x 75' (96.5cm x 22.8m)	238 sf (22.1 sm)
Strong	15.4 oz/sy (508 g/sm)	38" x 75' (96.5cm x 22.8m)	238 sf (22.1 sm)
Ultra	21.0 oz/sy (700 g/sm)	48" x 75' (122cm x 22.8m)	300 sf (22.1 sm)
Corner Roll	9.5 oz/sy (238 g/sm)	9.5" x 150' (96.5cm x 45.7m)	150 lf (45.7 m)

*Allow about 10% waste for lapping all meshes (Strong, Ultra and Corner Roll Meshes are butted). Coverage will vary.

PRODUCT TEST STANDARDS

ASTM D76, ASTM D578, ASTM D579, ASTM D1777, ASTM D3659, ASTM D3775, ASTM D3776, ASTM D4029, ASTM D5035, ASTM E2098, ASTM E2486. MIL-Y-1140

Weave: Full Leno

Impact ASTM E2486 (Formerly EIMA 101.86)

ASTM D5035 Tensile (warp/fill)

<i>Standard Mesh</i>	Medium Impact Resistance 50-89 in-lbs (5.7-10.1J)	247/280
<i>Hi Tech Mesh</i>	Medium Impact Resistance 50-89 in-lbs (5.7-10.1J)	140/250
<i>Medium Mesh</i>	Medium Impact Resistance 50-89 in-lbs (5.7-10.1J)	300/500
<i>Medium & Standard</i>	High Impact Resistance 90-150 in-lbs (10.2-17.0J)	300/500
<i>Strong & Standard</i>	Ultra High Impact Resistance 150+ in-lbs (over17.0J)	350/600
<i>Ultra & Standard</i>	Ultra High Impact Resistance 150+ in-lbs (over17.0J)	750/500
<i>Corner Roll</i>		274/274

APPLICATION PROCEDURE

Job Conditions - Air and substrate temperature for embedment of the Reinforcing Mesh must be 40°F (5°C) or higher and must remain 40°F (5°C) or higher for a minimum of 24 hours. Provide temporary protection at all times until the wall system, including flashings, caps, and sealants, is completed to provide protection from climatic conditions and other potential damage.

Application - All imperfections in the insulation board must be rasped flush and any gaps in the insulation board must be filled with slivers of insulation. Apply the base coat over the entire surface of the insulation board in a thickness greater than that of the Reinforcing Mesh being used, approximately 1/16" (1.6 mm) for Standard Mesh and 3/32" (2.4 mm) for Ultra Mesh. Immediately embed the Aggre-flex Mesh into the wet base coat and smooth from the center to the edge to avoid wrinkles. Lap all meshes except Strong Mesh and Ultra Mesh a minimum of 2-1/2" (63.5 mm) on all sides. The reinforcing fabric must be continuous at all corners and lapped or abutted in accordance to Master Wall specifications. The color of the mesh shall not be visible but a slight mesh pattern may be visible. The overall minimum thickness of the base coat should be a nominal 1/16" (1.6 mm) when dry.

When applying Strong, Ultra or Corner Roll Mesh, tightly abut all edges and let cure for a minimum of 12 hours. Grind any imperfections with the edge of a stainless steel trowel or grinding stone, taking care not to damage the Aggre-flex Mesh, and apply a layer of Standard Mesh, Hi-Tech Mesh, or Medium Mesh as per the directions in the preceding paragraph. To minimize wall variations, the lap of the second mesh layer should not coincide with the abutment of the first layer.

Special Conditions and Recommendations

Apply wrapping, backwrapping mesh or other approved accessory at all terminations of the insulation board. This includes at the top and bottom of all walls and at all openings.

Aggre-flex Mesh may be wrapped from the face of the insulation board onto a foundation or onto the studs of an opening on barrier wall systems. In all cases, the exposed edges of the insulation board must be wrapped with Aggre-flex Mesh and base coat or an approved accessory trim.



Health & Safety

WARNING!

Causes eye and skin irritation.

Precautionary Statement

Wash hands thoroughly after handling. Wear protective gloves/protective clothing/eye protection/face protection.

Consult the Safety Data Sheet (SDS) in the Products section at masterwall.com for further health and safety information.

LIMITED WARRANTY

This product is subject to a written limited material or system warranty. Obtain a warranty from the Tech Support tab of our website. Refer to Specifications for more complete information on proper use and handling of this product.

Information contained in this product data sheet conforms to the standard detail recommendations and specifications for the installation of Master Wall Inc.® products and is presented in good faith. Master Wall Inc.® assumes no liability, expressed or implied as to the architecture, engineering, or workmanship of any project. This information may be concurrent with, or superseded by other applicable documents, such as specifications and details. Contact Master Wall Inc.® for the most current product information.
©2022 Master Wall Inc.®



Master Wall Inc.
Building a Culture of Excellence

PRODUCT DATA

PRIMECOAT PRIMER

High quality exterior acrylic primer that helps solidify and protect the surface. Integrally colored Primecoat Primer helps make finishes brighter and deeper, reduces efflorescence and extends finish coverage rates. Suitable for priming Master Wall® base coats, new stucco, masonry and concrete that has a pH of 13 or less.

FEATURES & BENEFITS

- Tintable sealer/primer with good hiding power
- Hot prime capable for pH 13 or less
- Reduces finish absorption for improved aesthetics and reduced finish color variations
- Recommended for extreme color changes, under very dark, vivid or bright topcoats or when top tier finishing is specified
- Extends finish coverage, required when spraying Superior Finishes and some specialty finishes
- 100% Acrylic Polymers for durability
- Water-based - easy clean up with water

Application Temperature: 40°-110°F (5°-43°C)

Dry to touch: 1 hour

Recoat Time: 2 hours

Dry Time: 12 hours at room temperature, working and drying time will vary with temperature and humidity.

JOB CONDITIONS

Air and substrate temperature for application of Primecoat must be 40°F (5°C) or higher and must remain 40°F (5°C) or higher for a minimum of 24 hours. Provide temporary protection to protect the wall system from damage until permanent flashings, caps and sealants are installed. Store materials within prescribed temperature limits and out of direct sunlight. Working and drying times are based upon normal room temperature conditions and will vary with temperature and humidity.

PREPARATION

The substrate must be approved by Master Wall Inc.®, clean, dry, structurally sound and free of efflorescence, oil, grease, form release agents and curing compounds or anything that would affect bond. Concrete and masonry should be cured a minimum of 28 days, stucco cured a minimum of 7-14 days or surfaces verified to have a pH less than 13.

Coverage per pail (sf/sm)*

1000-1200 sf/pail (93-112 sm)*

**All coverage is approximate and depend upon substrate, details and individual application*

Packaging/Shelf Life/Storage

Packaging: 5 gallon (19L) pail Pail

Shelf Life: 2 years

Storage: Protect from extreme heat - 90°F (32°C), freezing and direct sunlight.

Technical Data

Water Vapor Transmission (perms), ASTM E96 Vapor Permeable

Substrate Recommendations

Concrete – If preparing for a textured or specialty finish, all projections must be removed and any voids filled with a Master Wall® base coat as needed to provide an appropriate surface.

Masonry – If preparing for a textured or specialty finish, skim coat with a Master Wall® base coat to achieve a smooth level surface. If joints are not struck flush, multiple coats may be required. Contact Master Wall for more information.

Stucco – If additives were used in the stucco, it is recommended that a test patch be made to evaluate bond strength of the Primecoat to the stucco.

Master Wall® Base Coats or Finishes, Previously Painted Surfaces, Cement Composition Siding

Install/Apply and prepare according to published guidelines. Surfaces should be clean, dry, cured and ready to receive coatings.

APPLICATION PROCEDURE

Mixing - Thoroughly stir Primecoat into a homogeneous consistency. Small amounts of clean, potable water may be added to obtain a workable consistency. Do not over mix. Do not exceed 24 ounces (0.7L) of water per pail. Do not add accelerators or retarders to Primecoat.

Application - Primecoat can be applied by brush, roller, or airless spray equipment. When using a roller, a maximum 3/4" (19 mm) nap is recommended. Apply Primecoat in an even, continuous coat of about 3 mils, maintaining a wet edge.

Airless Spray Application - Pressure 2000 p.s.i., Tip .015- to .019 inch. Spray in a consistent manner or backroll after spraying for a consistent application.

Limitations - Primecoat is not intended for use as the final finish coat over Master Wall base coats or other approved substrates.

FOR PROFESSIONAL RESULTS

Apply coatings away from direct sunlight. Cold joints or color variations can occur if the finish dries too quickly. Under certain conditions dark colors may show efflorescence on the surface during the cure process.

Surfaces exposed to the weather must be sloped (6:12 minimum). Use of dark colors in high temperature climates can affect the performance of the system, especially EIFS and areas may need to be limited.

CLEAN UP

Tools and equipment can be cleaned with soapy water when Primecoat is wet.

Hazard: This chemical is not considered hazardous according to the OSHA Hazard Communication Standard 2012 (29 CFR 1910.1200).

VOC: Less than 50 g/L.

Approved Substrates

Master Wall® Base Coats
Stucco
Brick
Masonry
Concrete
Interior Drywall
Previously painted surfaces with bond test
Others approved in writing

Warning: KEEP CONTAINER CLOSED WHEN NOT IN USE. KEEP OUT OF THE REACH OF CHILDREN. NOT FOR INTERNAL CONSUMPTION. FOR INDUSTRIAL USE ONLY.

Consult the Safety Data Sheet (SDS) in the Products section at masterwall.com for further health and safety information.

LIMITED WARRANTY

This product is subject to a written limited material or system warranty. Obtain a warranty from the Tech Support tab of our website. Refer to Specifications for more complete information on proper use and handling of this product.

Information contained in this product data sheet conforms to the standard detail recommendations and specifications for the installation of Master Wall Inc.® products and is presented in good faith. Master Wall Inc.® assumes no liability, expressed or implied as to the architecture, engineering, or workmanship of any project. This information may be concurrent with, or superseded by other applicable documents, such as specifications and details. Contact Master Wall Inc.® for the most current product information. ©2022 Master Wall Inc.®



Master Wall Inc.®
Building a Culture of Excellence

PRODUCT DATA

SUPERIOR FINISHES

To finish strong you need a Superior Finish. Master Wall® finishes are crafted with one of the highest 100% acrylic polymer contents in our industry. This translates to extra durability, lower life-cycle maintenance and a longer lasting finish.

FEATURES & BENEFITS

- 100% Acrylic Polymers for durability
- Dirt Pickup Resistant (DPR) Polymer Formulation
- Quartz or Marble aggregate available
- 64 Standard Colors
- Custom color matching available
- DuroTone colorfast pigments, Excel mildew enhancement, Silicone Coat additive available
- Vapor Permeable - resists blistering and allows trapped water vapors to pass
- Low VOC—Suitable for Interior Use
- Water Based - easy clean up with water

Application Temperature: 40°-110°F (5°-43°C)

Working Time: 1/4 hr

Set Time: 8-12 hrs

Dry Time: 48-72 hrs at room temperature, working and drying time will vary with temperature and humidity.

JOB CONDITIONS

Air and substrate temperature for application of Superior Finishes must be 40°F (5°C) or higher and must remain 40°F (5°C) or higher for a minimum of 24 hours. Provide temporary protection to protect the wall system from damage until permanent flashings, caps and sealants are installed. Store materials within prescribed temperature limits and out of direct sunlight. High temperatures will reduce working times, Low temperatures and/or high humidity and pigment loading will extend working, set and dry times.

PREPARATION

The substrate must be approved by Master Wall Inc.®, clean, dry, structurally sound and free of efflorescence, oil, grease, form release agents and curing compounds or anything that would affect bond. Painted surfaces are not acceptable and must be removed. Concrete and surfaces should cure for a minimum of 28 days. Stucco should be cured until clean, dry and hard—typically 14 days with a pH of 10 or less (13 or less if Primecoat Primer is used).

Interior drywall should be finished and made ready for paint. Prime surfaces with Primecoat/Sanded Primecoat primer prior to finishing.

Coverage per pail (sf/sm)*

- Perfect Swirl 2.0, 120-150 (11-14)
- Fine Sand 1.0, 160-170 (15-15.8)
- Medium Sand 1.5, 130-150 (12-14)
- Versatex 0.5, Varies with Texture

**All coverage is approximate and depend upon substrate, details and individual application*

Packaging/Shelf Life/Storage Packaging:

- 5 gallon (19L) pail Pail

Shelf Life: 2 years

Storage: Protect from extreme heat (90°F, 32°C), freezing and direct sunlight.

Technical Data

ASTM B117 Salt Spray Resistance - Pass ASTM

C67 Freeze/Thaw - Pass

ASTM C297 Tensile Bond - 30 psi minimum

ASTM D968 Abrasion Resistance - Pass 500L

ASTM D2247/E2570 Water Resistance - Pass

ASTM D3273 Mildew Resistance - Pass 28 Days

ASTM E84 Surface Burning - Pass, FS=0, SD=0

ASTM E 96 Vapor Permeability - Pass, 12 perms, vapor open

ASTM E108 Flame Propagation - Pass

ASTM E2485/2570 (formerly EIMA 101.01)

Impact Resistance - Pass

ASTM G23/G154/G155 Accelerated Weathering - Pass 2000 Hours

ASTM G53 Accelerated Weathering - Pass 2000 Hours

APPLICATION PROCEDURE

Base Coats - Must be flat, dry hard, and free of efflorescence. Master Wall® base coats must cure a minimum of 12 hours before application of Superior Finish. Substrates of brick, masonry or concrete should be leveled smooth using either Master Wall® base coats or stucco.

Mixing - Thoroughly stir Superior Finish using a heavy duty 1/2" drill at 400 - 500 rpm and a heavy duty mixing paddle. Small amounts of clean, potable water may be added to obtain a workable consistency. To avoid color variations, add the same amount of water to each pail. Do not exceed 24 ounces (0.7L) of water per pail of finish.

Application - Apply a uniform thickness (about 1/16", 1.6 mm) of Superior Finish to the substrate using a stainless steel trowel. Spread evenly and then scrape the finish coat down to a thickness no greater than the largest aggregate in the material. Immediately float the finish coat using a plastic float to the desired texture. Always maintain a wet edge to achieve uniformity of texture and color. Allow the finish to fully dry and set before exposure to inclement weather.

FOR PROFESSIONAL RESULTS

Apply finish coats away from direct sunlight. Cold joints or color variations can occur if the finish dries too quickly. Priming stucco surfaces with Primecoat/Sanded Primecoat evens out finish absorption and should be strongly considered and specified for dark colored finishes, especially those using Ultra Deep Base (UDB) tint base and over stucco to avoid efflorescence blush. Under certain conditions dark colors may show efflorescence on the surface during the cure process.

Surfaces exposed to the weather must be sloped (6:12 minimum). Use of dark colors in high temperature climates can affect the performance of the system, especially EIFS and areas may need to be limited.

Deep, intense colors should be specified with DuroTone pigments to maintain colorfastness longer. Verify specialty colors with your Master Wall® Distributor. Finishes are intended for the approved substrates listed above and should not be applied directly to gypsum board or insulation board products.

CLEAN UP

Tools and equipment can be cleaned with soapy water while the Superior Finish is still wet.

Hazard: This chemical is not considered hazardous according to the OSHA Hazard Communication Standard 2012 (29 CFR 1910.1200).

VOC: Less than 50 g/L.

See Superior Finishes for other technical properties

Approved Substrates

Master Wall® Base Coats
Cemplaster Fiberstucco, One Coat Stucco (OCS), Primecoat Primer surfaces, ASTM C926 Stucco

Prepared & Base Coated Surfaces of:
Brick, Concrete, Masonry
Others approved in writing

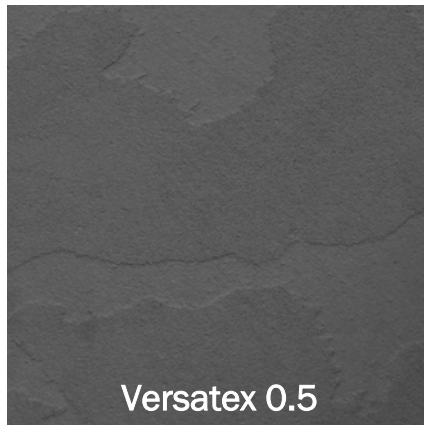
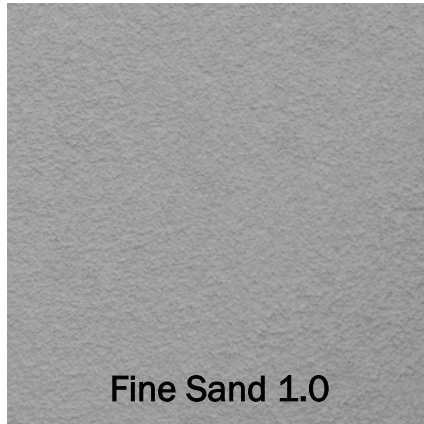

Information contained in this product data sheet conforms to the standard detail recommendations and specifications for the installation of Master Wall Inc.® products and is presented in good faith. Master Wall Inc.® assumes no liability, expressed or implied as to the architecture, engineering, or workmanship of any project. This information may be concurrent with, or superseded by other applicable documents, such as specifications and details. Contact Master Wall Inc.® for the most current product information. ©2022 Master Wall Inc.®



Health & Safety

WARNING!

Causes eye and skin irritation.
 Precautionary Statement
 Wash hands thoroughly after handling. Wear protective gloves/protective clothing/eye protection/face protection.

FIRST AID MEASURES

Eye Contact: Immediately flush eyes with plenty of water for at least 15 to 20 minutes. Ensure adequate flushing of the eyes by separating the eyelids with fingers. Get immediate medical attention.

Skin Contact: Immediately wash skin with plenty of soap and water for 15 to 20 minutes, while removing contaminated clothing and shoes. Get medical attention if irritation develops or persists.

Inhalation: If inhaled, remove to fresh air. If not breathing, give artificial respiration or give oxygen by trained personnel. Seek immediate medical attention.

Ingestion: If swallowed, do NOT induce vomiting. Call a physician or poison control center immediately. Never give anything by mouth to an unconscious person.

Store locked up. Dispose of contents/container in accordance with Local, State, Federal and Provincial regulation.

Spills: Collect with suitable absorbent material such as cotton rags.

Disposal: Dispose of in accordance with local, state or federal regulations.

Warning: KEEP CONTAINER CLOSED WHEN NOT IN USE. KEEP OUT OF THE REACH OF CHILDREN. NOT FOR INTERNAL CONSUMPTION. FOR INDUSTRIAL USE ONLY.

Consult the Safety Data Sheet (SDS) in the Products section at masterwall.com for further health and safety information.

LIMITED WARRANTY

This product is subject to a written limited material or system warranty. Obtain a warranty from the Tech Support tab of our website. Refer to Specifications for more complete information on proper use and handling of this product.



Master Wall Inc.®

Building a Culture of Excellence

P.O. Box 397 Fortson, GA 31808 800-755-0825 FAX 706-569-0092

masterwall.com

Stucco Cement Board Coatings

SC05 5-year Limited Warranty
SC10PC 10-year Limited Warranty
SC10RS 10-year Limited Warranty
SC10RSPC 10-year Limited Warranty
SC12PC 12-year Limited Warranty
SC12RS 12-year Limited Warranty
SC12RSPC 12-year Limited Warranty

Master Wall Inc.® warrants the properly designed and installed Stucco Cement Board Coatings and SuperiorShield air/water barrier products (if used) and materials used in the systems for the length noted above from the date of installation. Master Wall Inc.'s exclusive liability under this warranty is to supply replacement materials and labor or corrective procedures, if it is shown that the materials supplied by Master Wall Inc., were defective when installed by the Master Wall Inc. certified applicator. Remedies shall be solely determined by Master Wall Inc. and no other warranties are expressed or implied. For a valid warranty, the system and products must be installed in accordance with Master Wall Inc.'s written recommendations, specifications, details, bulletins and other project-specific written recommendations. Master Wall Inc. must be notified in writing within 10 business days of the original discovery of the defect.

Master Wall Inc. is not responsible for structural conditions, design conditions beyond those noted in our literature, architecture, engineering, or workmanship of any project. Stucco Cement Board Coatings may have hairline cracks, spalling, fastener popping or efflorescence, which are not considered product defects. Drainage Systems are warranted to drain incidental water for the warranty period. Materials must be properly stored and applied in a timely manner. Workmanship, aesthetics, and installation are beyond the scope of this warranty as are any deviations from Master Wall Inc. Documents not specifically approved in writing.

Abuse, misuse, excessive weather, or environmental conditions beyond what the products or systems have been tested, designed, or approved for is expressly limited. Certain colors with organic pigments are less fade-resistant than others. The building, system and products must be properly maintained in accordance with Master Wall Inc., documents, local environmental conditions, and good building practices. In no case is Master Wall Inc. responsible for incidental and consequential damages.

This warranty becomes effective only when all bills for the components of the system have been paid.

Except as stated, Master Wall, Inc.®, expressly disclaims any warranty of merchantability or fitness for a particular purpose. The above remedies are to be deemed exclusive.

This is not the final warranty. For a valid warranty click on the support tab at masterwall.com and request a warranty. Warranties are not valid until issued.



Stucco Cement Board Coatings with Drainage SCBC12RSPC Section 09 93 63



Master Wall Inc.®
PO Box 397
Fortson, GA 31808
706-569-0092
800-755-0825
www.masterwall.com

Master Wall Guide Specification SCBC12RSPC Stucco Cement Board Coatings Assemblies

Stucco Cement Board Coatings 12

- Framing and sheathing (by others)
- Rollershield LAB Air/Water Barrier – included in warranty if used
- Kene® 020-1 Drainage Mat
- Approved Cement Board (by others)
- Cement Board Mesh at seams
- Standard Mesh
- Master Wall Base Coat
- Primecoat Primer
- Superior Finish or other Master Wall® Finish
- 12-year Labor/Material Limited Warranty

- Continuous Insulation Options
- Insulated Cement Board Options

PART I – GENERAL

1.01 SUMMARY

A. This document is to be used in preparing specifications for projects utilizing the Master Wall Inc.® Stucco Cement Board Coatings applied over approved cement boards and designed to provide drainage of incidental water entering the system. Related Master Wall Inc.® documents:

1. Master Wall Inc.® Stucco Cement Board Coatings with Drainage System Data Sheet
2. Master Wall Inc.® Stucco Cement Board Coatings with Drainage System Application Instructions
3. Master Wall Inc.® Stucco Cement Board Coatings with Drainage System Installation Details
4. Master Wall product data sheets

B. Related Sections

1. Unit Masonry – Section 04 20 0
2. Concrete – Sections 03 30 0 and 03 40 00
3. Light Gauge Cold Formed Steel Framing – Section 05 40 00
4. Wood Framing – Section 06 10 00
5. Insulation – 07 21 00
6. Sealant – Section 07 90 00
7. Flashing – Section 07 60 00

1.02 SUBMITTALS

- A. Manufacturer's specifications, details, installation instructions and product data
- B. Manufacturer's standard warranty
- C. Applicator's industry training credentials
- D. Samples for approval as directed by architect or owner
- E. Sealant manufacturer's certificate of compliance with ASTM C 1382
- F. Prepare and submit project-specific details (when required by contract documents)



Stucco Cement Board Coatings with Drainage SCBC12RSPC

Section 09 93 63

1.03 REFERENCES

A. ASTM Standards:

- ASTM B117 (Federal Test Standard 141A Method 6061) Standard Practice for Operating Salt Spray (Fog) Apparatus
- ASTM C150 Standard Specification for Portland Cement
- ASTM C297 Standard Test Method for Flatwise Tensile Strength of Sandwich Constructions
- ASTM C578 Specification for Preformed Cellular Polystyrene Thermal Insulation
- ASTM C1177 Standard Specification for Glass Mat Gypsum Substrate for Use as Sheathing
- ASTM C1396 (formerly C 79) Standard Specification for Gypsum Board
- ASTM D968 (Federal Test Standard 141A Method 6191) Standard Test Methods for Abrasion Resistance of Organic Coatings by Falling Abrasive
- ASTM D1784 Specification for Rigid Poly (Vinyl Chloride) (PVC) and Chlorinated Poly (Vinyl Chloride) (CPVC) Compounds
- ASTM D2247 (Federal Test Standard 141A Method 6201) Standard Practice for Testing Water Resistance of Coatings in 100% Relative Humidity
- ASTM D3273 Standard Test Method for Resistance to Growth of Mold on the Surface of Interior Coatings in an Environmental Chamber
- ASTM E84 Standard Test Method for Surface Burning Characteristics of Building Materials
- ASTM E96 Test Methods for Water Vapor Transmission of Materials
- ASTM E330 Test Method for Structural Performance of Exterior Windows, Doors and Curtain Walls by Uniform Static Air Pressure Difference
- ASTM E331 Test Method for Water Penetration of Exterior Windows, Skylights, Doors and Curtain Walls by Uniform Static Air Pressure Difference.
- ASTM E2098 Test Method for Determining Tensile Breaking Strength of Glass Fiber Reinforcing Mesh for Use in Class PB Exterior Insulation and Finish System after exposure to Sodium-Hydroxide Solution
- ASTM E2178 Test Method for Air Permeance of Building Materials
- ASTM E2357 Standard Test Method for Determining Air Leakage of Air Barrier Assemblies
- ASTM E2485 (formerly EIMA Std. 101.01) Standard Test Method for Freeze-Thaw Resistance of Exterior Insulation and Finish Systems and Water-Resistive Barrier Coatings
- ASTM E2486 (formerly EIMA Std. 101.86) Standard Test Method for Impact Resistance of Class PB and PI Exterior Insulation and Finish Systems
- ASTM G23 Standard Practice for Operating Light-Exposure Apparatus (Carbon-Arc Type) with and without Water for Exposure of Nonmetallic Materials
- ASTM G53 Practice for Operating Light- and Water-Exposure Apparatus (Fluorescent UV-Condensation Type) for Exposure of Nonmetallic Materials

B. Other Referenced Documents

- American Association of Textile Chemists and Colorists AATCC-127 Water Resistance: Hydrostatic Pressure Test
- APA Engineered Wood Association E30, Engineered Wood Construction Guide



Stucco Cement Board Coatings with Drainage SCBC12RSPC

Section 09 93 63

1.04 SYSTEM DESCRIPTION

- A. General: Master Wall Inc.® Stucco Cement Board Coatings applied over approved cement boards and designed to provide drainage of incidental water entering the system, consisting base coat, reinforcing mesh and finish. The cement board shall be attached over a structural substrate and air/water barrier in accordance with the Stucco Cement Board Coatings with Drainage application Details.
- B. Methods of Installation
 - 1. Field Applied: The Stucco Cement Board Coatings with Drainage System is applied to the substrate system in place.
 - 2. Panelized: The Stucco Cement Board Coatings with Drainage System is shop-applied to the prefabricated wall panels.
- C. Design Requirements
 - 1. Sheathing & Stucco Cement Board
 - a. The maximum deflection under full flexural design loads of the substrate system shall not exceed $L/360$.
 - b. Acceptable sheathings for the Stucco Cement Board Coatings shall be designed for their intended use by the design professional.
 - c. Since the surface of the sheathing and stucco cement board cannot be rasped smooth, the flatness and finished appearance of the Stucco Cement Board Coatings application will depend on the structural members that support the sheathing.
 - d. The project architect or engineer shall engineer the framing, sheathing and stucco cement board with regard to the required structural performance.
 - 2. The substrate shall be flat within 6.4 mm (1/4 in) in a 3.05 m (10 ft) radius.
 - 3. The slope of inclined surfaces shall not be less than 6:12, and the length shall not exceed 305 mm (12 in).
 - 4. Sheathing is required for conditioned northern climates and where necessary for structural concerns in all climates. Non-conditioned northern climates (above the 4000-heating degree day line) and southern climates may not require sheathing. Designer to determine the necessity and use of the sheathing.
 - 5. When the outside temperatures differ considerably from the building's interior temperature, airborne dirt can accumulate on colder regions of walls causing "shadowing" or "spotting", particularly over fasteners and framing. This is not considered a failure of the system or the Master Wall materials.
 - 6. Weather Resistive Barrier
 - a. Code approved weather resistive barrier shall be installed over framing on all exterior walls before application of the cement board begins.
 - b. Master Wall Rollershield is used as the water barrier over approved substrates.
 - 7. Expansion Joints
 - a. Design and location of expansion joints in the Stucco Cement Board Coatings with Drainage System is the responsibility of the project designer and shall be noted on the project drawings. As a minimum, expansion joints shall be placed at the following locations:
 - 1) Where expansion joints occur in the substrate system.
 - 2) Where building expansion joints occur.
 - 3) At floor lines in wood frame construction (Reference Technical Bulletin #140).
 - 4) At floor lines of non-wood framed buildings where significant movement is expected.
 - 5) Where the Stucco Cement Board Coatings with Drainage System abuts dissimilar materials.
 - 6) Where the substrate type changes
 - 7) Where prefabricated panels abut one another
 - 8) Where significant structural movement occurs such as changes in roofline, building shape or structural system.



Stucco Cement Board Coatings with Drainage SCBC12RSPC Section 09 93 63

8. Control Joints
 - a. Control joints are required and located by the designer in the stucco cement board at the following locations: (Reference construction documents for specific locations).
 - 1) Shall not exceed 20 lineal feet in any direction.
 - 2) 160 square feet equals maximum overall area.
 - 3) One dimension shall not exceed 2 ½ times the other dimension.
 - 4) At all dissimilar substrate transitions.
 - b. Double studs may be required to accommodate control joints or where it is needed to provide a fastening base for sheathing board joints.
9. Terminations
 - a. Interior foam expanding foam sealant may be required behind penetration openings.
 - b. The Stucco Cement Board Coatings with Drainage System shall be held back from adjoining materials around openings and penetrations such as windows, doors, and mechanical equipment a minimum of 12.7 mm (1/2 in) for sealant application. Sealant joints shall be properly sized and designed for their anticipated movement (Reference Master Wall Inc.® Technical Bulletins #148 & 149).
 - c. The system shall be terminated a minimum of 152 mm (6 in) above finished grade.
 - d. Sealants
 - 1) Shall be manufactured and supplied by others.
 - 2) Shall be compatible with Stucco Cement Board Coatings with Drainage System materials. Refer to current Master Wall Inc.® Technical Bulletin #131 for listing of sealants approved by sealant manufacturer for use with stucco systems.
 - 3) The sealant backer rod shall be of closed cell.
10. Vapor Retarders and barriers – The use and location of vapor retarders and/or barriers within a wall assembly is the responsibility of the project designer and shall comply with local building code requirements.
11. Dark Colors - The use of dark colors must be considered in relation to wall surface temperature as a function of local climatic conditions. Use of dark colors in high temperature climates can affect the performance of the system.
12. Flashing: Shall be provided at all roof-wall intersections, windows, doors, chimneys, decks, balconies, and other areas as necessary to prevent water from entering behind the Stucco Cement Board Coatings with Drainage System and wall system.



Stucco Cement Board Coatings with Drainage SCBC12RSPC

Section 09 93 63

1.05 PERFORMANCE REQUIREMENTS

A. Stucco Cement Board Coatings with Drainage System shall have been tested as follows:

Weather Resistance and Durability Performance*

TEST	METHOD	CRITERIA	RESULTS
1. Accelerated Weathering	ASTM G 153 (Formerly ASTM G 23)	No deleterious effects at 2000 hours when viewed under 5x magnification	Pass
2. Accelerated Weathering	ASTM G 154 (Formerly ASTM G 53)	No deleterious effects at 2000 hours	Pass
3. Freeze/Thaw Resistance	ASTM E 2485	No deleterious effects at 10 cycles when viewed under 5x magnification	Pass
4. Water Penetration	ASTM E 331 (modified per ICC-ES AC 235)	No water penetration beyond the plane of the base coat/insulation board interface after 15 minutes at 6.24 psf (299 Pa) or 20% of design wind pressure, whichever is greater	Pass at 2.86 psf (137 Pa), 6.24 psf (299 Pa), and 12.0 psf (575 Pa) consecutively
5. Water Resistance	ASTM D 2247	No deleterious effects at 14-day exposure	Pass @ 28 days
6. Salt Spray	ASTM B 117	No deleterious effects* at 300 hours	Pass @ 300 hrs.
7. Abrasion Resistance	ASTM D 968	No cracking or loss of film integrity at 528 quarts (500 L) of sand	Pass
8. Mildew Resistance	ASTM D 3273	No growth supported during 28-day exposure period	Pass

Fire Performance

TEST	METHOD	CRITERIA	RESULT
1. Surface Burning (individual components)	ASTM E 84	Individual components shall each have a flame spread of 25 or less, and smoke developed of 450 or less	Flame Spread: 0 Smoke Developed: 0

Component Performance

TEST	METHOD	CRITERIA	RESULT
1. Alkali Resistance of Reinforcing Mesh	ASTM E2098 (formerly EIMA 105.01)	Greater than 120 pli (21 dN/cm) retained tensile strength	Pass
2. Requirements for Rigid PVC Accessories	ASTM D 1784	Meets cell classification 13244C	Pass



Stucco Cement Board Coatings with Drainage SCBC12RSPC

Section 09 93 63

1.06 QUALITY ASSURANCE

A. Qualifications

1. System Manufacturer: Shall be Master Wall Inc.®. All materials shall be manufactured or sold by Master Wall Inc.® and shall be purchased from Master Wall Inc.® or its authorized distributors.
2. Contractor: Shall be knowledgeable in the proper installation of the Master Wall Inc.® Stucco Cement Board Coatings with Drainage System and shall be experienced and competent in the installation of Exterior Finish Systems. Additionally, the contractor shall possess a current Master Wall Inc.® applicator certificate issued by Master Wall Inc.®

B. Regulatory Requirements

1. The EPS shall be separated from the interior of the building by a minimum 15-minute thermal barrier.
2. The use and maximum thickness of EPS shall be in accordance with the applicable building codes.

C. Mock-Up

1. The contractor shall, before the project commences, provide the owner/architect with a mock-up for approval.
2. The mock-up shall be of suitable size as required to accurately represent the products being installed, as well as each color and texture to be utilized on the project.
3. The mock-up shall be prepared with the same products, tools, equipment, and techniques required for the actual application. The finish used shall be from the same batch that is being used on the project.
4. The approved mock-up shall be available and maintained at the job site.
5. For panelized construction, the mock-up shall be available and maintained at the panel fabrication location.

1.07 DELIVERY, STORAGE AND HANDLING

- A. All Master Wall Inc.® materials shall be delivered to the job site in the original, unopened packages with labels intact.
- B. Upon arrival, materials shall be inspected for physical damage, freezing, or overheating. Questionable materials shall not be used.
- C. Deliver all materials in original unopened packages with labels intact. Verify all quantities, colors, and textures against bill of lading.
- D. Store all materials protected from direct exposure to weather conditions and at temperatures not less than 40°F (4°C) or greater than 110°F (43°C).
- E. Material Safety Data Sheets (MSDS) or Safety Data Sheets (SDS) shall be supplied for the components of the system and be available at the job site.

1.08 PROJECT CONDITIONS

- A. Ambient air temperatures shall be 40°F (4°C) or greater and rising at the time of installation of the Master Wall Inc.® products and shall remain at 40°F (4°C) or greater for at least 24 hours after application.
- B. Provide supplemental heat and protection as required when the temperature and conditions are not in accordance with installation requirements. Sufficient ventilation and time shall be provided to ensure that materials have sufficiently dried prior to removing supplemental heat.
- C. Adequate protection shall be provided to prevent weather conditions (humidity, temperature, and precipitation) from influencing the curing or drying time of Master Wall Inc.® materials.
- D. Adjacent materials and the Stucco Cement Board Coatings with Drainage System shall be protected during installation and while curing from weather and shall be protected from site damage.
- E. Coordinate installation of the Stucco Cement Board Coatings with Drainage System with related work specified in other sections to ensure that the wall assembly is protected to prevent water from getting behind the system. The cap flashing shall be installed as soon as possible after the finish coat has been applied. When this is not possible, temporary protection shall be provided immediately in this area.
- F. All sealant work shall be installed in a timely manner. Protect open joints from water intrusion during construction with backer rod, or temporary covering, until permanently sealed.
- G. Sufficient manpower and equipment shall be employed to ensure a continuous operation, free of cold joints, scaffolding lines, and texture variations, etc.



Stucco Cement Board Coatings with Drainage SCBC12RSPC

Section 09 93 63

H. Existing Conditions - The contractor shall have access to electric power, clean water, and a clean work area at the location where the Master Wall Inc.® materials are to be applied.

1.09 SEQUENCING AND SCHEDULING

- A. Installation of the Stucco Cement Board Coatings with Drainage System shall be coordinated with other construction trades.
- B. Sufficient manpower and equipment shall be employed to ensure a continuous operation, free of cold joints, scaffold lines, texture variations, etc.

1.10 LIMITED MATERIALS WARRANTY

- A. Provide a manufacturer's warranty against defective material upon request.

1.11 MAINTENANCE

- A. Maintenance and repair shall follow the procedures noted in Master Wall Inc.® Technical Bulletins #112 and #129.

PART II – PRODUCTS

2.01 MANUFACTURER

- A. All components of the Stucco Cement Board Coatings with Drainage System shall be supplied or obtained from Master Wall Inc.® or its authorized distributors. Substitutions or additions of materials other than specified will void the warranty.

2.02 MATERIALS

- A. Portland Cement: Shall be Type I or II, meeting ASTM C 150, white or gray in color, fresh and free of lumps.
- B. Water: Shall be potable, clean, and free of foreign matter.
- C. Metal Flashing Components: Complying with SMACNA Recommendations. Reference Section 07620.
- D. Sealant Systems: Reference Sealant Specification, Section 07900.
- E. Window & Door Systems: Detailed by the designer and suitable for the regional application. Reference Section 08000.

2.03 WALL COMPONENTS

A. Sheathing & Cement Board

- 1. Sheathing: Applied over framing and may be designed to satisfy structural requirements or fire-resistive construction. Exterior gypsum sheathing (ASTM 1133 (Dens Glass Gold or similar), ASTM C1396, Exposure 1 or exterior plywood (grade C-D or better), Exposure 1 Oriented Strand Board (OSB).
- 2. Stucco Cement Board: Cementitious panels meeting ASTM C-1325. National Gypsum® PermaBase® (1/2" or 5/8" thick) PermaBase CI Insulated Cement Board™ (2" thick) or approved equal.

B. Air/Water Barrier

1. SuperiorShield Water Barrier & Flashing Tapes:

- A. SuperiorShield Rollershield RS: A 100% pure acrylic-based roll-applied weather-resistive barrier.
- B. SuperiorShield Rollershield TG: A 100% pure acrylic-based trowel grade water-resistive barrier.
- C. SuperiorShield Rollershield VB: Acrylic-based vapor barrier water resistive barrier.
- D. SuperiorShield Flashing Tape: A lightweight nonwoven joint treatment material.
- E. SuperiorShield Mesh Tape: A lightweight joint treatment material.
- F. SuperiorFlash: A single-component fluid applied flashing.

C. Insulation Board (Optional)

- 1. Molded Expanded Polystyrene (EPS) Insulation Board meeting ASTM C578.
- 2. Extruded Polystyrene (XPS) Insulation Board meeting ASTM C578.
- 3. Polyisocyanurate Insulation Board; Hunter Panel Xci.
- 4. Insulation board thickness limited to 2" (50.8 mm) maximum.



Stucco Cement Board Coatings with Drainage SCBC12RSPC

Section 09 93 63

D. Starter Tracks/Drainage Tracks/Starter Flashing

1. Vinyl Corp. foundation sill screed product #WS50-250U, Plastic Components Product # 632-50, Amico Foundation Weep Screed AMFWS425-500, Amico Foundation Weep Screed (NO. 7) or approved equal.
2. Vinyl Corp. PB Starter Strip/Casing Bead product # CBS 150-16W or Plastic Components Starter Trac product # STWP-15 shall be used in accordance with Master Wall Inc.® details.
3. Alternate termination methods may be used in accordance with Master Wall Inc.® details and recommendations.

E. Mechanical Fasteners

1. A rust resistant fastener approved by the Stucco Cement Board manufacturer shall be used to properly fasten the sheathing. The appropriate fastener shall be used to meet the requirements of the specific project, local building code and the anticipated wind loads. Wind-Lock Hard-Roc Sheathing Fasteners (F-HR) or approved equal.

F. Drainage Mats

1. Approved by Master Wall Inc., Keene 020-1.

G. Reinforcing Mesh

1. Cement Board Mesh – Open weave glass fiber fabric, treated for alkaline resistance and compatibility with Master Wall Base Coats.
2. Open weave glass fiber fabric, treated for alkaline resistance and compatibility with Master Wall Base Coats, and conforming ASTM D-76, D-579, D-5035, MIL-Y-1140 and meeting a minimum Medium Impact Resistance (50-89 in-lbs) when tested to EIMA 101.86 Impact Resistance Standards.
 1. Detail Mesh
 2. Standard Mesh

H. Base Coats

1. Master Wall Inc.® Foam & Mesh (F&M) Adhesive: An acrylic-based product mixed one-to-one by weight with Portland cement for use with reinforcing mesh as the base coating over the cement board.
2. Master Wall Bagged Base Coat (MBB): A polymer based cementitious product mixed with 5 to 6 quarts of water for use with reinforcing mesh as the base coating over the cement board.
3. F&M Plus: An acrylic-based high build product mixed one-to-one by weight with Portland cement designed for use with reinforcing mesh as the base coating over the cement board. (This product shall be used where indicated on the construction drawings when a leveling base coat is required.)
4. Expanded Polystyrene Base (EPSB): a 100% pure acrylic polymer based noncementitious base coat.

I. Water Resistant Adhesive & Base Coat

1. Guardian – An acrylic-based product mixed one-to-one by weight with Portland cement for use as a base coat with reinforcing mesh over cement board. (This product should be used as designated on the construction drawings where additional resistance to moisture is needed.)

J. Primer

1. Primecoat Primer - Acrylic-based tintable primer
2. Sanded Primecoat Primer - Acrylic-based tintable primer with sand

K. Superior Finishes: Master Wall Inc.® Superior Finishes are acrylic-based wall coatings available in a variety of colors and textures. The following textures are available:

1. Perfect2.0 - riled texture
2. Fine Sand 1.0 – sand type texture
3. Medium Sand 1.5 – coarse sand texture
4. Versatex 0.5 – Fine texture used to create numerous finishes



Stucco Cement Board Coatings with Drainage SCBC12RSPC

Section 09 93 63

PART III – EXECUTION

3.01 EXAMINATION

- A. Prior to installation of the Stucco Cement Board Coatings with Drainage System, the contractor shall verify that the substrate:
 - 1. Is of a type listed in the specifications.
 - 2. Is flat within 6.4 mm (1/4 in) in a 3 m (10 ft) radius.
 - 3. Is sound, dry, connections are tight, has no surface voids, projections or other conditions that may interfere with the Stucco Cement Board Coatings with Drainage System installation or performance.
- B. Prior to the installation of the Stucco Cement Board Coatings with Drainage System, the architect or general contractor shall insure that all needed flashings and other waterproofing details have been completed, if such completion is required prior to the Stucco Cement Board Coatings with Drainage application. Additionally, the Contractor shall ensure that:
 - 1. Metal roof flashing has been installed in accordance with Asphalt Roofing Manufacturers Association (ARMA) Standards.
 - 2. Openings are flashed in accordance with the Stucco Cement Board Coatings with Drainage System Installation Details or as otherwise necessary to prevent water penetration.
 - 3. Chimneys, Balconies, and Decks have been properly flashed.
 - 4. Windows, Doors, etc. are installed and flashed per manufacturer's requirements and the Stucco Cement Board Coatings with Drainage System Installation Details.
- C. Prior to the installation of the Stucco Cement Board Coatings with Drainage System, the contractor shall notify the general contractor, and/or architect, and/or owner of all discrepancies.

3.02 PREPARATION

- A. Stucco Cement Board Coatings with Drainage materials shall be protected by permanent or temporary means from inclement weather and other sources of damage prior to, during, and following application until completely dry.
- B. Protect adjoining work and property during Stucco Cement Board Coatings with Drainage installation.
- C. The substrate shall be prepared as to be free of foreign materials, such as, oil, dust, dirt, form release agents, efflorescence, paint, wax, water repellents, moisture, frost and any other condition that inhibit adhesion.

3.03 GENERAL GUIDELINES

- A. The system shall be installed in accordance with the current Master Wall Inc.® Stucco Cement Board Coatings with Drainage System Application Instructions.
- B. The overall minimum base coat thickness shall be sufficient to fully embed the mesh.
- C. Sealant shall not be applied directly to textured finishes.
- D. When installing the Stucco Cement Board Coatings with Drainage System, adhere according to Master Wall Inc.® and local requirements.

3.04 STUCCO CEMENT BOARD COATINGS INSTALLATION

- A. Design Considerations
 - 1. The minimum slope of inclined surfaces shall not be less than 6" (152 mm) in 12" with a maximum length of 12" unless approved in writing by Master Wall Inc.®. Inclined surfaces which are or could be defined as roofs by the building codes or application are not approved by Master Wall Inc.®
 - 2. The use of dark colors must be considered in relation to wall surface temperature as a function of local climatic conditions.
 - 3. The Insulation Board, if used, shall be separated from the interior of the building by a 15-minute thermal barrier.
 - 4. It is the responsibility of the architect and the purchaser to determine if a product is suitable for their intended use. The architect or designer of the project shall be responsible for all decisions pertaining to the design, details, structural capability, attachment details, shop drawings and the like. Master Wall Inc.® has prepared specifications, details, and data sheets to assist as guidelines for the use and installation of the



Stucco Cement Board Coatings with Drainage SCBC12RSPC

Section 09 93 63

products. Master Wall Inc.® is not responsible for the design, details, structural capability, attachment details and shop drawings whether it is based on Master Wall Inc.® information or not.

5. Expansion joints in the system are required at building expansion joints, at prefabricated panel joints, where substrates change, at floor lines in wood framed construction, and where structural movement is anticipated. Reference construction documents for exact locations.
6. Aesthetic Joints may be installed to provide sufficient break points in the EIF System to prevent cold joints from occurring in the finish coat. Aesthetic joints shall not be used in lieu of an expansion joint

B. Mixing

1. Mix the products following the instructions on the product data sheets.
2. Additives shall not be added to Master Wall Inc.® materials unless written approval has been received from Master Wall Inc.®

C. Preparation

1. Protect contiguous work from damage during application of the Stucco Cement Board Coatings with Drainage. Temporary covering may be required to prevent over spray or splattering of exterior finish coatings on other work.
2. Protect substrate from inclement weather during installation. Prevent infiltration of moisture behind the system.
3. Adhesive, Base Coats and Finishes shall not be installed when ambient air temperature is below 40°F (4°C). The temperature shall remain at or above 40°F (4°C) during mixing, application and until materials have cured.
4. Sufficient scaffolding, manpower and tools shall be provided to prevent cold joints.
5. Flashings, water barriers and drainage spacers (if used) shall be installed as required by construction documents and Master Wall Inc.® details in a manner to prevent the intrusion of water behind the cement board and wall system. All flashing materials should direct the water to the exterior face of the finished system.

D. Installation, General

1. Reference architectural details for full wall system requirements.
2. Comply with the manufacturers' current published instructions, (specifications, details, data sheets and technical bulletins) for the installation of the Stucco Cement Board Coatings with Drainage EIF System.
3. Comply with local building codes.
4. Verify that all flashings and other items are in place.

E. Drainage Track or Termination Option

1. Install the L-flashing or alternate termination method where the system ends at the foundation. Install flashing at least 6" (152 mm) above grade, at least ¾" (19 mm) above structurally supported paving/patios, or at least 2" (51 mm) above unsupported patios in accordance with manufacturer's instructions.

3.05 FIELD QUALITY CONTROL

- A. The contractor shall be responsible for the proper application of the Stucco Cement Board Coatings with Drainage materials.
- B. Master Wall Inc.® assumes no responsibility for on-site inspections or application of its products.
- C. If required, the contractor shall certify in writing the quality of work performed relative to the substrate system, details, installation procedures, workmanship and as to the specific products used.
- D. If required, the EPS supplier shall certify in writing that the EPS meets Master Wall Inc.® specifications.
- E. If required, the sealant contractor shall certify in writing that the sealant application is in accordance with the sealant manufacturer's and Master Wall Inc.® recommendations.
- F. Acceptable weather resistive barriers for the Stucco Cement Board Coatings with Drainage System shall be:
 1. SuperiorShield, follow the Rollershield LAB product detailing requirements.
 2. Install drainage mat materials in accordance with manufacturer's details and/or accepted industry practices.
- G. Master Wall Inc.'s current published details, specifications, data sheets, technical bulletins and other literature/information are minimum standards and guidelines that shall be followed when designing and detailing a project with the Stucco Cement Board Coatings with Drainage EIF System.
- H. Details shall conform to Master Wall Inc.'s details and shall be consistent with the project requirements.
- I. Master Wall Inc. must approve deviations from the standard published details in writing.



Stucco Cement Board Coatings with Drainage SCBC12RSPC

Section 09 93 63

- J. The architect, engineer or the designer of the project should determine where the dew point would occur in relationship to the wall assembly and the project location during summer and winter conditions.
- K. Drip details shall be specified in accordance with Master Wall Inc.'s published details.
- L. At all locations the reinforced base coat, trim accessories or the substrate shall encapsulate the approved insulation board.

3.06 STUCCO CEMENT BOARD APPLICATION

A. Mechanical Fasteners

1. A rust resistant fastener approved by the sheathing manufacturer shall be used to properly fasten the Stucco Cement Board. Appropriate fastener shall be used to meet the requirements of the specific project, local building code and the anticipated wind loads.

B. Optional Insulation Boards

1. Tack fasten insulation boards to the framing or substrate using appropriate corrosion resistant fasteners and plates, as necessary.

C. Cement Board Installation

1. Approved cement board for application:
 - a) National Gypsum® PermaBase® or PermaBase CI Insulated Cement Board™.
 - b) Others as approved in writing.
2. Make sure the weather resistive barrier is lapped over and into the drainage track and onto the flange of the casing bead.
3. Attach cement board using appropriate fastener.
4. Fastening patterns shall be determined by the requirements of the geographical conditions of the area, local code requirements and the performance of the fasteners and their test results in conjunction with the specified substrate and the thickness of sheathing specified for use.
5. Install fasteners so that the face of the fastener head is flush or slightly recessed into the surface of the sheathing board.
6. The application of the sheathing board shall commence at the base of the wall in the drainage track from a level line of support.
7. Boards shall be installed so that the vertical joints are staggered.
8. Board joints shall be offset from the corners of openings.
9. Allow for proper spacing at windows, doors, penetrations and other openings so that sealant systems can be installed in accordance with Master Wall Inc.'s specification, details and the construction documents.
10. Provide a proper joint through sheathing board where building expansion joints are detailed and where required in the system.
11. Double studs are required if needed to accommodate control joints, expansion joints, or where it is needed to provide a fastening base for sheathing board joints.
12. The sheathing board shall be butted tightly, except at locations where control joints are planned.

3.07 CONTROL JOINTS

- A. Mechanically attach the control joints in accordance with construction documents, the recommendations of the manufacturer of the control joint, and Master Wall Inc.'s specifications and details.
- B. Fasten control joint with corrosion resistant fasteners of sufficient length to penetrate the wood studs at least 1" (25 mm), and the steel.
- C. Alternatively space the boards where needed if the hidden control joint method is used.

3.08 BASE COAT PREPARATION

- A. Inspect Stucco Cement Board to ensure the installation meets the requirements set forth in the sheathing manufacturer's installation instructions, Master Wall Inc.'s specification, details, data sheets, technical bulletins and the construction documents. Make necessary repairs to ensure the installation meets the requirements prior to commencement of the base coat application.



Stucco Cement Board Coatings with Drainage SCBC12RSPC

Section 09 93 63

3.09 CEMENT BOARD MESH APPLICATION

- A. Center the Master Wall Cement Board Mesh over all Stucco Cement Board joints, inside and outside corners and all breaks in the board. Lap mesh a minimum of 2-1/2" (64 mm).
- B. Immediately apply base coat to the Cement Board Mesh and taper the base coat to a featheredge. Alternatively, embed the Cement Board Mesh into wet base coat.
- C. Allow the base coat to cure to a firm set before applying the Base Coat.

3.10 BASE COAT APPLICATION

A. Base Coat Application

1. Apply the base coat to the entire surface of the cement board to the thickness required for the specified reinforcing mesh to be applied in a given area.
 - a. Standard, Detail and Hi-Tech Mesh require a nominal 1/16" (1.6 mm).
2. Immediately embed Master Wall Inc.® reinforcing mesh into wet base coat with a trowel, working from the center toward the edges, until the mesh is fully covered, and a smooth surface is achieved. The color of the mesh shall not be visible, but a slight mesh pattern may be visible.
3. Lap mesh 2 1/2" (64 mm) minimum on all sides.
4. Reinforcing Mesh shall be continuous through all interior and exterior corners extending beyond the corner a minimum of 12" from both directions creating a minimum of two layers of standard reinforcing mesh on all interior and exterior corners.
5. EPS shapes shall have reinforcing mesh embedded into the base coat.
6. Allow the base coat to cure a minimum of 12 hours prior to additional base coat or finish coat applications.

3.11 FINISH COAT APPLICATION

A. Superior Finish Coat Application

1. Surface irregularities in the base coat, such as trowel marks and reinforcing mesh laps shall be corrected prior to the finish application.
2. Prime wall surface with Primecoat, allow to dry before finish coat application.
3. Apply the Master Wall Inc.® Superior Finish in the color and texture as approved by the project owner or the project architect with sufficient manpower and equipment to insure a continuous operation without cold joints, scaffolding lines etc. Texture finish shall match approved jobsite samples. Thickness and coverage will vary depending on the specified final appearance. Apply Primecoat according to data sheet instructions if specified.
4. Trowel Application – (Perfect 2.0, Fine Sand 1.0, Medium Sand 1.5, Versatex 0.5)
 - a. Apply the Superior Finish to the clean, dry, and cured base coat with a stainless-steel trowel.
 - b. Level the surface to a uniform thickness of 3/32" to 1/8" (2.4-3.2 mm).
 - c. Float the Finish with a plastic float in a uniform motion to achieve the desired texture. (Versatex 0.5 cannot be floated easily. A second application of the Versatex 0.5 may be applied to create the desired texture.)
5. Spray Application – (Perfect 2.0, Fine Sand 1.0, Medium Sand 1.5, Versatex 0.5)
 - a. Using a conventional plaster hopper gun or a proven pump, spray finish over the primed base coat to achieve desired texture using a circular overlapping pattern keeping the spray gun at a 90° angle to the surface and maintaining the same distance to the wall at all times.
 - b. Be cautious of flooding an area with too much finish because it may appear shinier when it dries.
6. Specialty Finishes: Follow individual product data sheet application instructions.

3.12 JOB SITE CLEANUP

- A. Clean work area in accordance with contract documents removing all excess materials, droppings, and debris. Clean adjacent surfaces.
- B. Other trades may now install their work – Sheet Metal (Section 07620), Sealants (Section 07900), Mechanical (Section 15000), Electrical (Section 16000).



Stucco Cement Board Coatings with Drainage SCBC12RSPC Section 09 93 63

3.13 PROTECTION

- A. Stucco Cement Board Coatings with Drainage System shall be protected from inclement weather and other sources of damage until dry and permanent protection in the form of flashings, sealants, etc. are installed.

Disclaimer

This Specification is published for general informational purposes only and is not intended to imply that these are the only materials, procedures, or methods, which are available or suitable. Materials, procedures, or methods may vary according to the circumstances, local building code requirements, design conditions, or statutory and regulatory requirements. While the information in this specification is believed to be accurate and reliable, it is presented without guarantee or responsibility on the part of Master Wall Inc.®



Master Wall Inc.®

Building a Culture of Excellence

P.O. Box 397 Fortson, GA 31808 800-755-0825 FAX 706-569-0092

masterwall.com

Stucco Cement Board Coatings

SC05 5-year Limited Warranty
SC10PC 10-year Limited Warranty
SC10RS 10-year Limited Warranty
SC10RSPC 10-year Limited Warranty
SC12PC 12-year Limited Warranty
SC12RS 12-year Limited Warranty
SC12RSPC 12-year Limited Warranty

Master Wall Inc.® warrants the properly designed and installed Stucco Cement Board Coatings and SuperiorShield air/water barrier products (if used) and materials used in the systems for the length noted above from the date of installation. Master Wall Inc.'s exclusive liability under this warranty is to supply replacement materials and labor or corrective procedures, if it is shown that the materials supplied by Master Wall Inc., were defective when installed by the Master Wall Inc. certified applicator. Remedies shall be solely determined by Master Wall Inc. and no other warranties are expressed or implied. For a valid warranty, the system and products must be installed in accordance with Master Wall Inc.'s written recommendations, specifications, details, bulletins and other project-specific written recommendations. Master Wall Inc. must be notified in writing within 10 business days of the original discovery of the defect.

Master Wall Inc. is not responsible for structural conditions, design conditions beyond those noted in our literature, architecture, engineering, or workmanship of any project. Stucco Cement Board Coatings may have hairline cracks, spalling, fastener popping or efflorescence, which are not considered product defects. Drainage Systems are warranted to drain incidental water for the warranty period. Materials must be properly stored and applied in a timely manner. Workmanship, aesthetics, and installation are beyond the scope of this warranty as are any deviations from Master Wall Inc. Documents not specifically approved in writing.

Abuse, misuse, excessive weather, or environmental conditions beyond what the products or systems have been tested, designed, or approved for is expressly limited. Certain colors with organic pigments are less fade-resistant than others. The building, system and products must be properly maintained in accordance with Master Wall Inc., documents, local environmental conditions, and good building practices. In no case is Master Wall Inc. responsible for incidental and consequential damages.

This warranty becomes effective only when all bills for the components of the system have been paid.

Except as stated, Master Wall, Inc.®, expressly disclaims any warranty of merchantability or fitness for a particular purpose. The above remedies are to be deemed exclusive.

This is not the final warranty. For a valid warranty click on the support tab at masterwall.com and request a warranty. Warranties are not valid until issued.

Stucco Cement Board Coating System Detail

Fasten to Framing Members per manufacturer's instructions at a maximum of 8" (20 cm) centers

Water Barrier, **Rollershield** shown or other code-recognized equivalent

Cement Board Mesh at seams

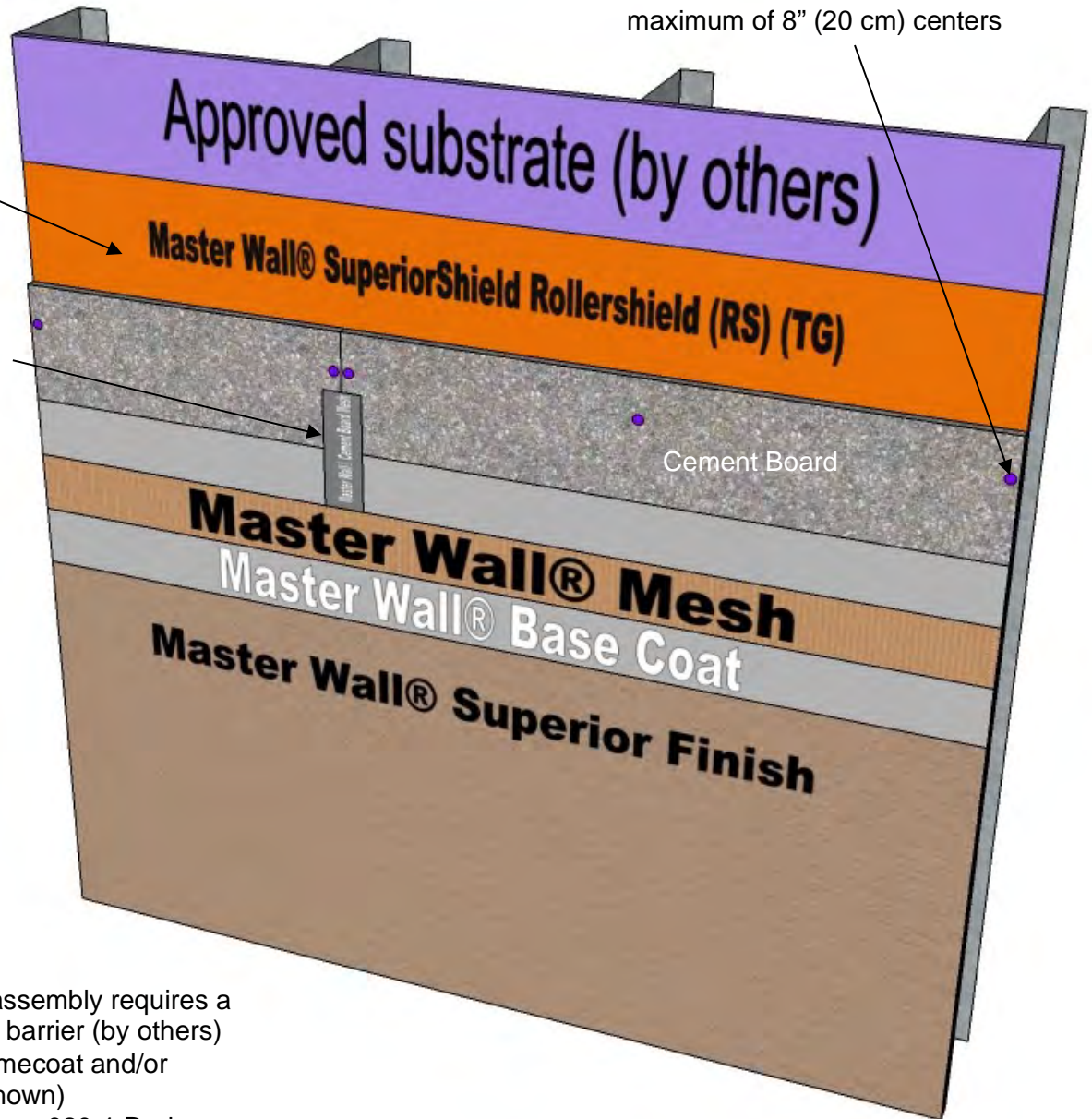

Notes

- Typical SC05 assembly requires a standard water barrier (by others)
- SC10 adds Primecoat and/or Rollershield (shown)
- SC12 adds Keene 020-1 Drainage Mat under SC10

SC-01 Typical Cross Section

These drawings relay the conceptual conditions of Master Wall® Systems and are not the construction drawings. Ultimately the design and detailing of an entire wall system is the responsibility of a professional. These details will guide the design professional in the use of Master Wall® Products. Master Wall disclaims design, warranty or construction intent or responsibility. Bold or Brand Name = Master Wall® Product.

©2020 Master Wall Inc.®

Stucco Cement Board Coating System Detail

Fasten to Framing Members per manufacturer's instructions at a maximum of 8" (20 cm) centers

Water Barrier, **Rollershield** shown or other code-recognized equivalent

Cement Board Mesh at seams

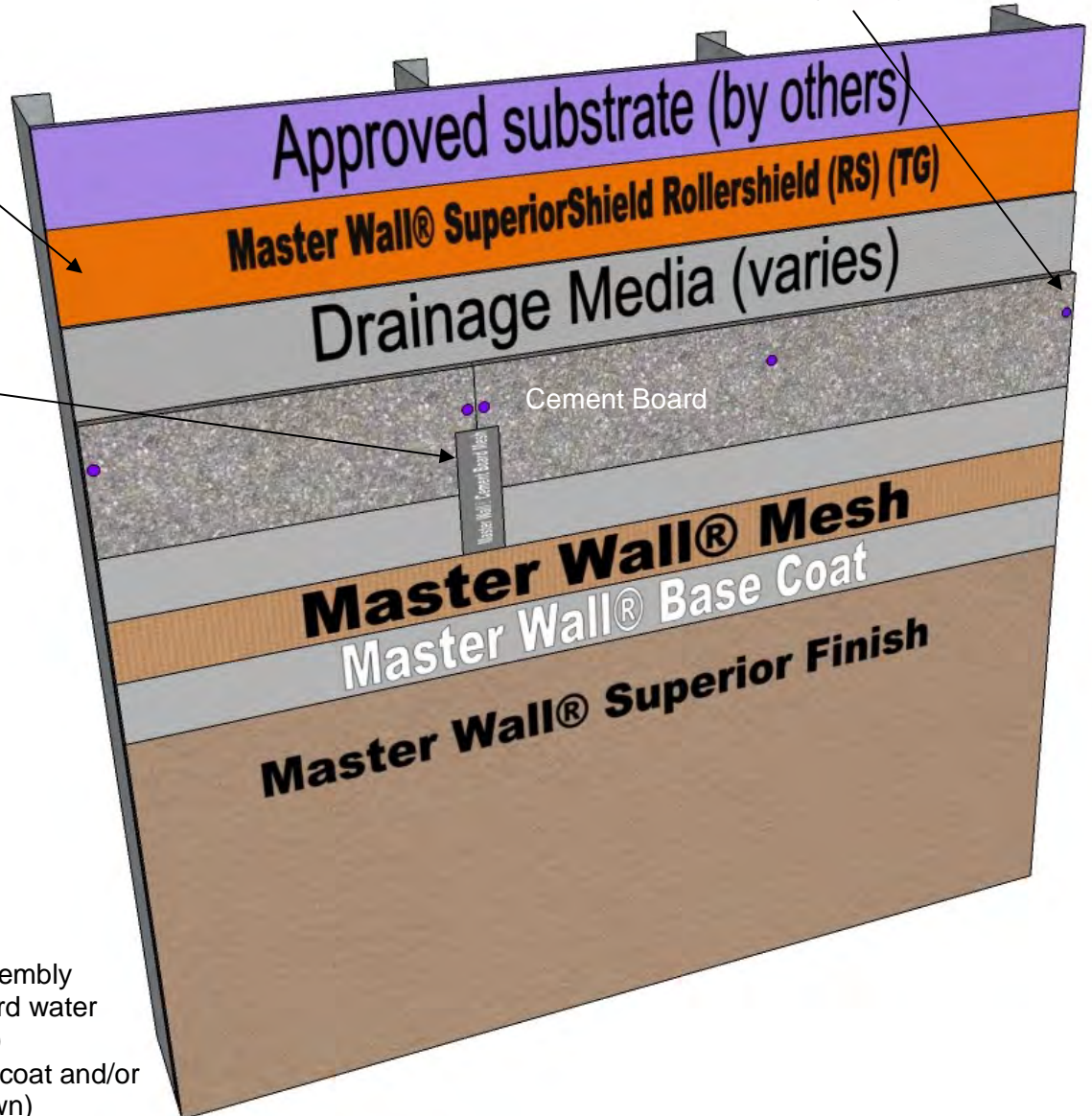

Notes

- Typical SC05 assembly requires a standard water barrier (by others)
- SC10 adds Primecoat and/or Rollershield (shown)
- SC12 adds Keene 020-1 Drainage Mat under SC10

SC-02 Typical Cross Section with Drainage Mat

These drawings relay the conceptual conditions of Master Wall® Systems and are not the construction drawings. Ultimately the design and detailing of an entire wall system is the responsibility of a professional. These details will guide the design professional in the use of Master Wall® Products. Master Wall disclaims design, warranty or construction intent or responsibility. Bold or Brand Name = Master Wall® Product. ©2020 Master Wall Inc.®

Stucco Cement Board Coating System Detail

Fasten to Framing Members per manufacturer's instructions at a maximum of 8" (20 cm) centers

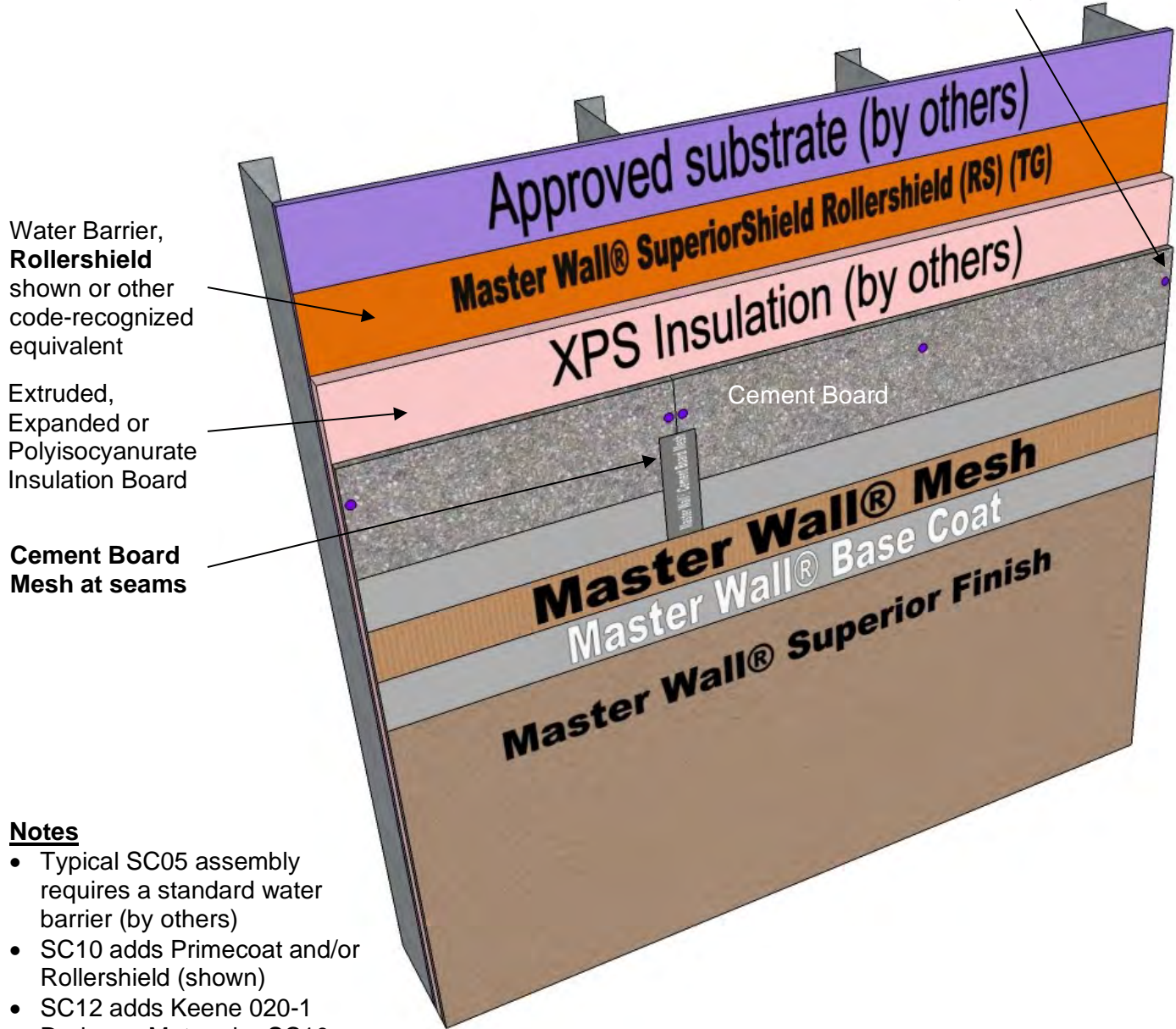

Notes

- Typical SC05 assembly requires a standard water barrier (by others)
- SC10 adds Primecoat and/or Rollershield (shown)
- SC12 adds Keene 020-1 Drainage Mat under SC10

SC-03 Typical Cross Section with Insulation Board

These drawings relay the conceptual conditions of Master Wall® Systems and are not the construction drawings. Ultimately the design and detailing of an entire wall system is the responsibility of a professional. These details will guide the design professional in the use of Master Wall® Products. Master Wall disclaims design, warranty or construction intent or responsibility. Bold or Brand Name = Master Wall® Product. ©2020 Master Wall Inc.®

Stucco Cement Board Coating System Detail

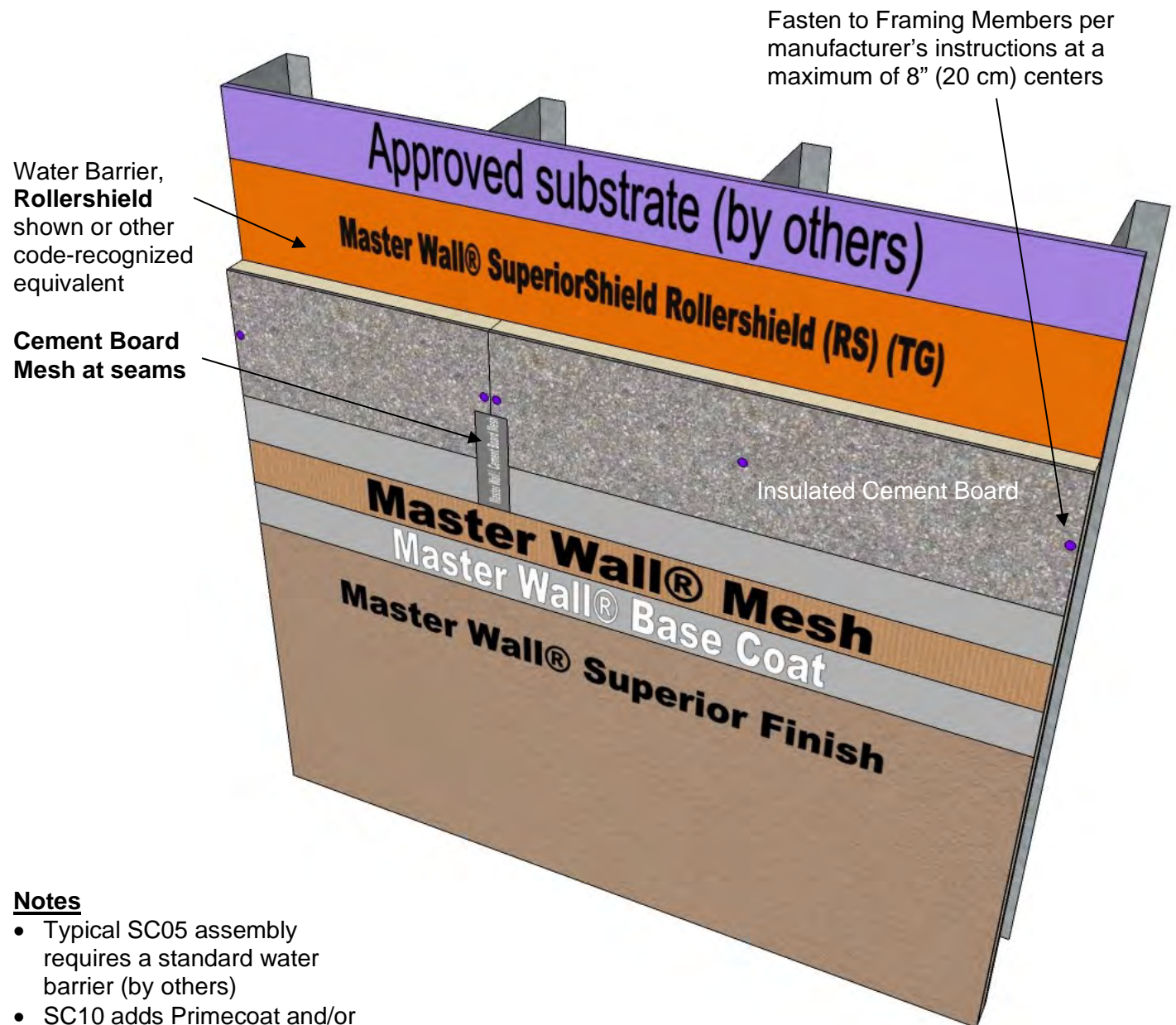

Notes

- Typical SC05 assembly requires a standard water barrier (by others)
- SC10 adds Primecoat and/or Rollershield (shown)
- SC12 adds Keene 020-1 Drainage Mat under SC10

SC-04 Typical Cross Section with Insulated Cement Board

These drawings relay the conceptual conditions of Master Wall® Systems and are not the construction drawings. Ultimately the design and detailing of an entire wall system is the responsibility of a professional. These details will guide the design professional in the use of Master Wall® Products. Master Wall disclaims design, warranty or construction intent or responsibility. Bold or Brand Name = Master Wall® Product. ©2020 Master Wall Inc.®

Stucco Cement Board Coating System Detail

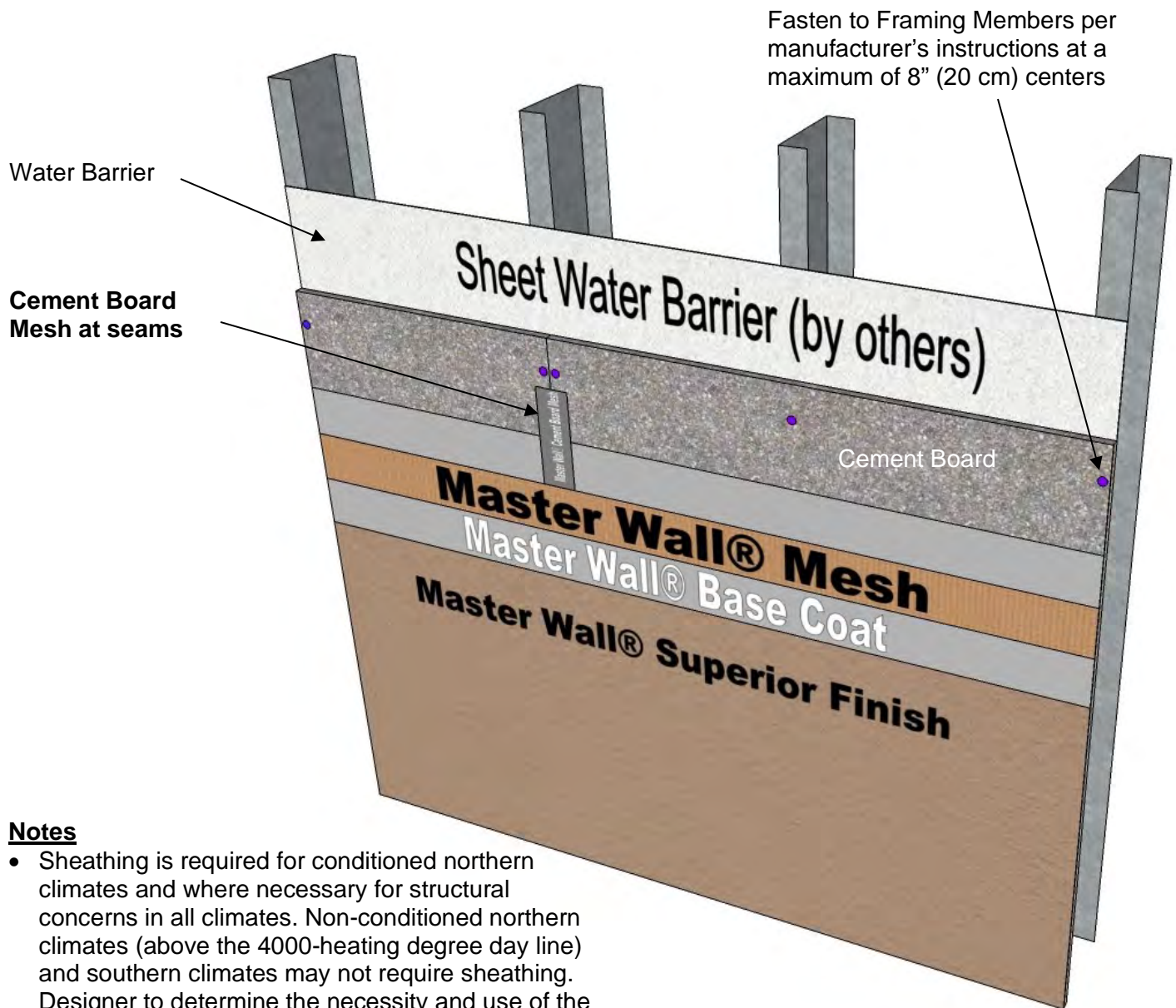

Notes

- Sheathing is required for conditioned northern climates and where necessary for structural concerns in all climates. Non-conditioned northern climates (above the 4000-heating degree day line) and southern climates may not require sheathing. Designer to determine the necessity and use of the sheathing.
- Typical SC05 assembly requires a standard water barrier (by others)
- SC10 adds Primecoat

SC-05 Typical Cross Section Over Framing

These drawings relay the conceptual conditions of Master Wall® Systems and are not the construction drawings. Ultimately the design and detailing of an entire wall system is the responsibility of a professional. These details will guide the design professional in the use of Master Wall® Products. Master Wall disclaims design, warranty or construction intent or responsibility. Bold or Brand Name = Master Wall® Product. ©2020 Master Wall Inc.®

Stucco Cement Board Coating System Detail

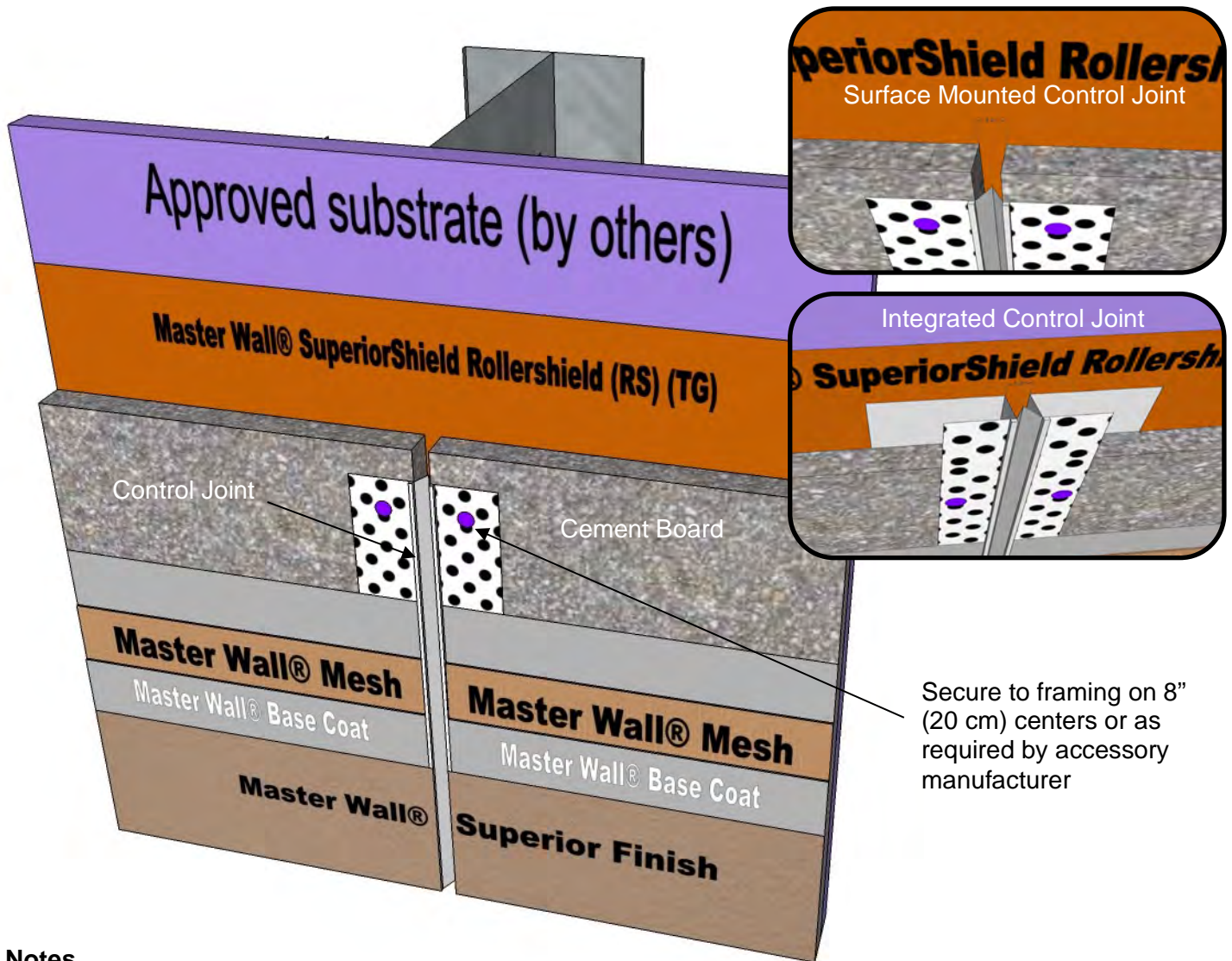

Notes

- Control joints are required and should be located by the designer at the following locations on the construction documents:
 - Maximum length shall not exceed 20 lineal feet in any direction
 - 160 sf is the maximum overall area
 - One dimension shall not exceed 2-1/2 times the other dimension
 - At all dissimilar substrate/sheathing transitions
- Double studs may be required to accommodate control joints or where it is needed to provide a fastening base for sheathing board joints.

SC-06 Control Joint Detail

These drawings relay the conceptual conditions of Master Wall® Systems and are not the construction drawings. Ultimately the design and detailing of an entire wall system is the responsibility of a professional. These details will guide the design professional in the use of Master Wall® Products. Master Wall disclaims design, warranty or construction intent or responsibility. Bold or Brand Name = Master Wall® Product. ©2020 Master Wall Inc.®

Stucco Cement Board Coating System Detail

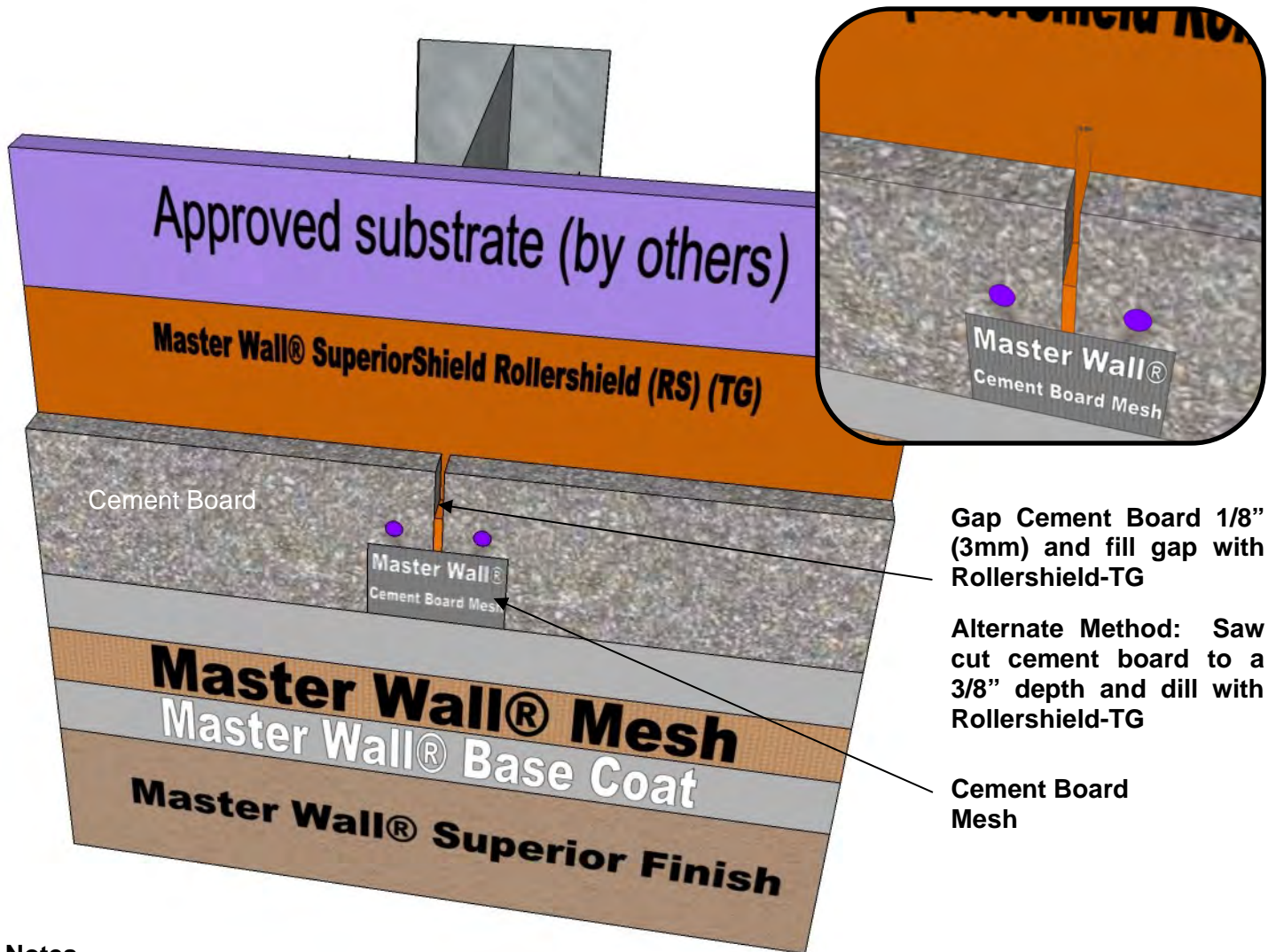

Notes

- Control joints are required and should be located by the designer at the following locations on the construction documents:
 - Maximum length shall not exceed 20 lineal feet in any direction
 - 160 sf is the maximum overall area
 - One dimension shall not exceed 2-1/2 times the other dimension
 - At all dissimilar substrate/sheathing transitions
- Double studs may be required to accommodate control joints or where it is needed to provide a fastening base for sheathing board joints.
- Cracking or signs of movement may occur at joint location.

SC-07 Hidden Control Joint Detail

These drawings relay the conceptual conditions of Master Wall® Systems and are not the construction drawings. Ultimately the design and detailing of an entire wall system is the responsibility of a professional. These details will guide the design professional in the use of Master Wall® Products. Master Wall disclaims design, warranty or construction intent or responsibility. Bold or Brand Name = Master Wall® Product. ©2020 Master Wall Inc.®

Stucco Cement Board Coating System Detail

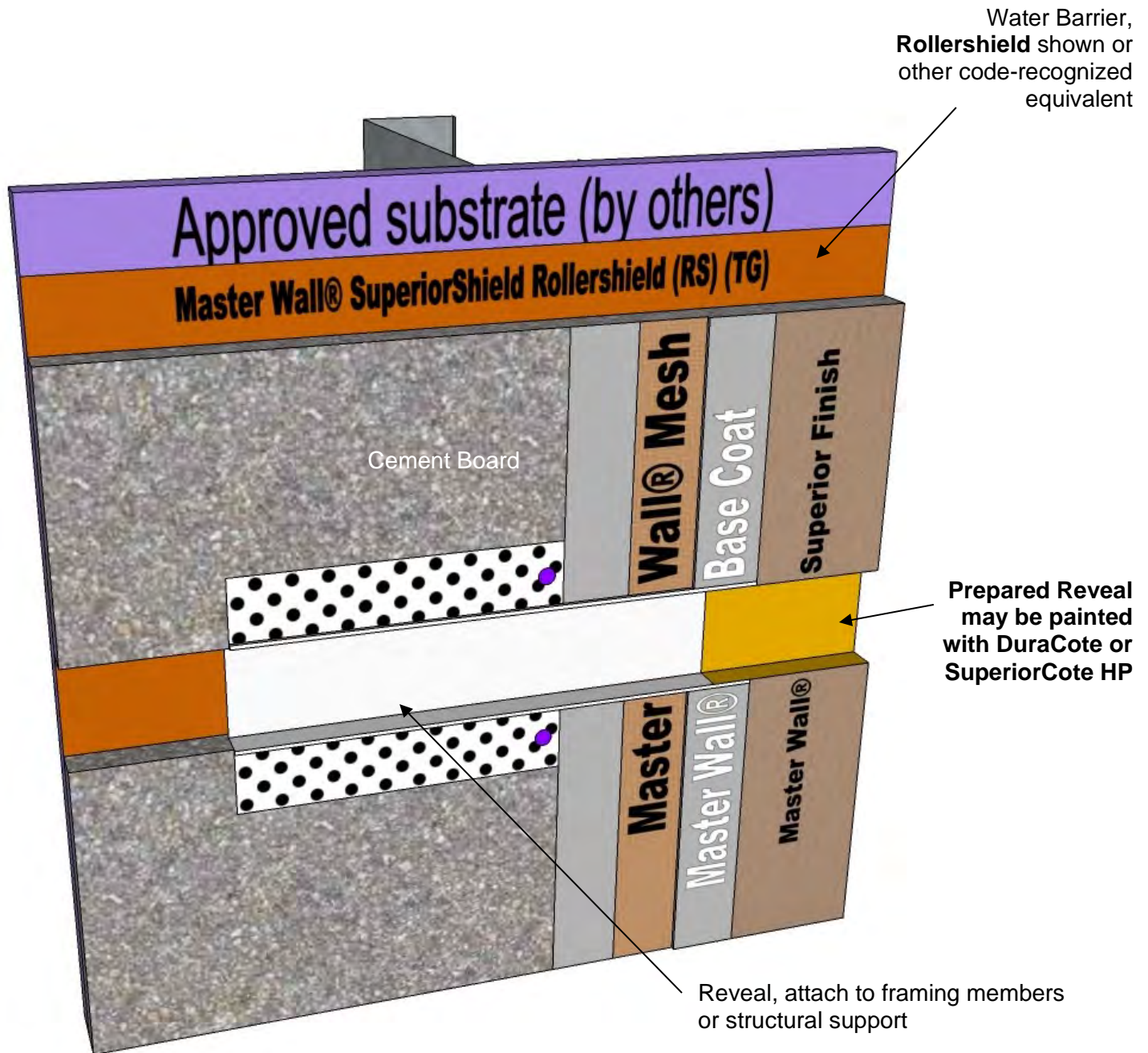

SC-08 Typical Reveal

These drawings relay the conceptual conditions of Master Wall® Systems and are not the construction drawings. Ultimately the design and detailing of an entire wall system is the responsibility of a professional. These details will guide the design professional in the use of Master Wall® Products. Master Wall disclaims design, warranty or construction intent or responsibility. Bold or Brand Name = Master Wall® Product. ©2020 Master Wall Inc.®

Stucco Cement Board Coating System Detail

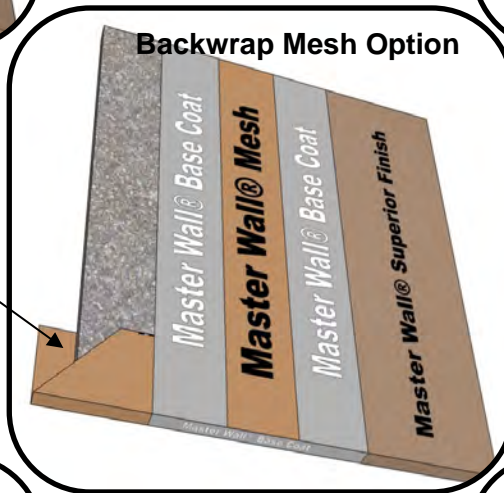

Wrap Mesh 2-1/2"
 (63.5 mm)

Insulated – Plastic
 Accessory Option

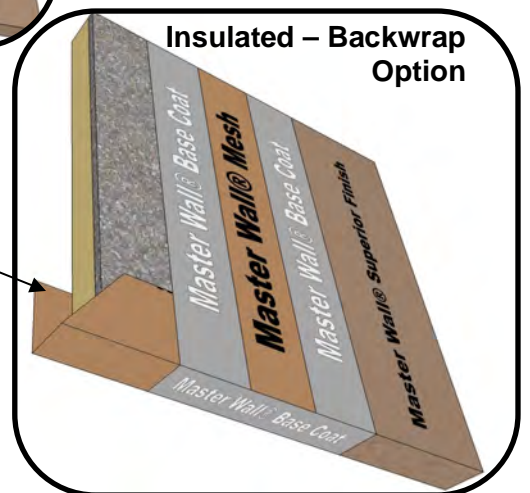
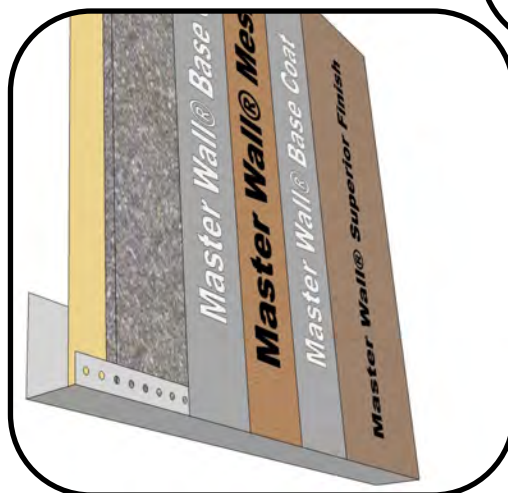

Wrap Mesh 2-1/2"
 (63.5 mm)

SC-09 Cement Board Encapsulation Options

These drawings relay the conceptual conditions of Master Wall® Systems and are not the construction drawings. Ultimately the design and detailing of an entire wall system is the responsibility of a professional. These details will guide the design professional in the use of Master Wall® Products. Master Wall disclaims design, warranty or construction intent or responsibility. Bold or Brand Name = Master Wall® Product. ©2020 Master Wall Inc.®

Stucco Cement Board Coating System Detail



Notes

- Place flashing 1" (25 mm) onto foundation.
- Keep system 6" (152 mm) above grade, a minimum of 2" (50 mm) above unsupported pavement, or 3/4" (19 mm) above supported floors.

SC-10 Detail at Grade

These drawings relay the conceptual conditions of Master Wall® Systems and are not the construction drawings. Ultimately the design and detailing of an entire wall system is the responsibility of a professional. These details will guide the design professional in the use of Master Wall® Products. Master Wall disclaims design, warranty or construction intent or responsibility. Bold or Brand Name = Master Wall® Product. ©2020 Master Wall Inc.®

Stucco Cement Board Coating System Detail

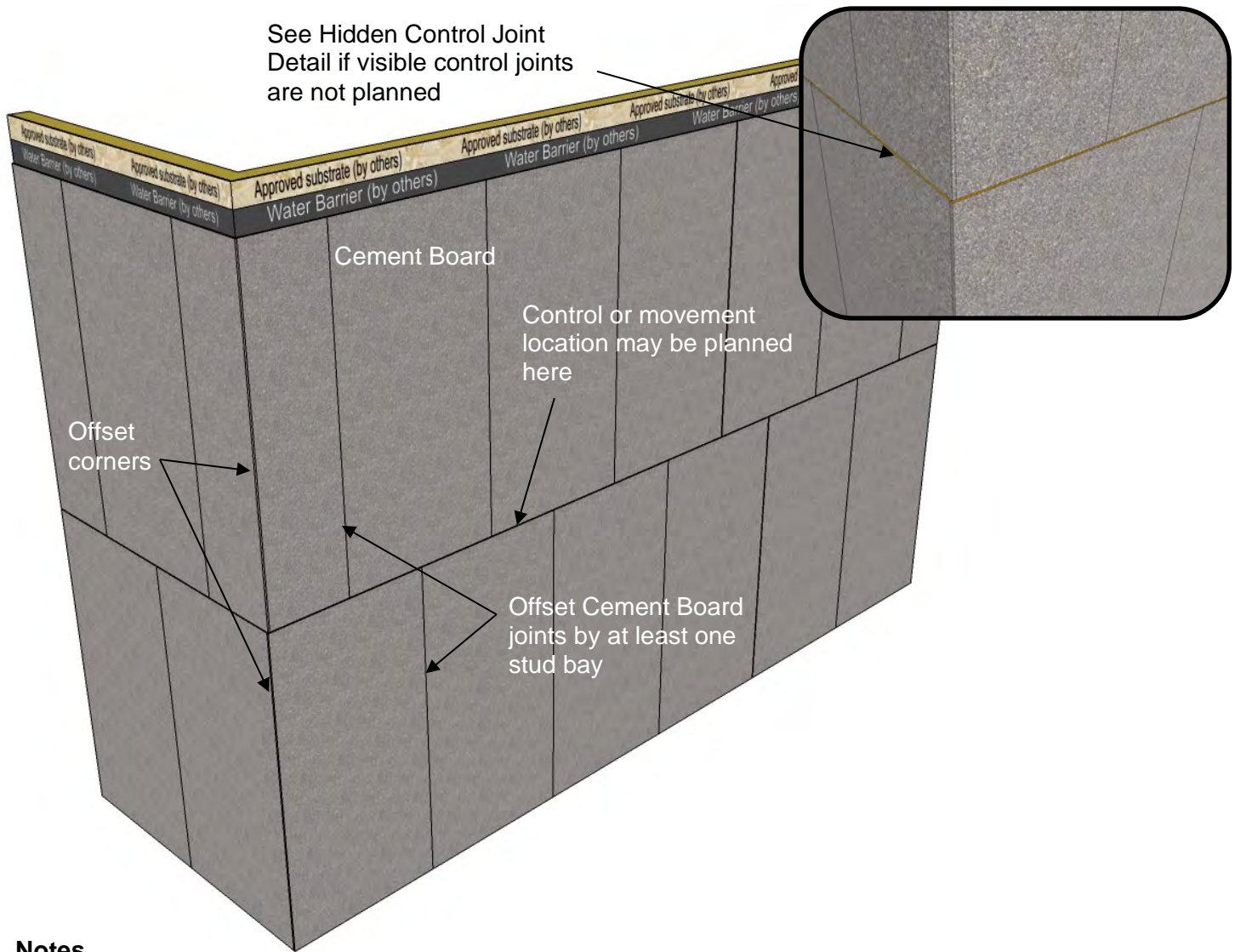

Notes

- Attach cement board to framing members using cement board manufacturer approved coated fasteners spaced as required and a maximum of 8" (20.3 cm) centers.
- Offset cement board joints at window and door openings (See Mesh Layout Detail SC-12).
- Gap all wood-based sheathing substrates 1/8" (3 mm) minimum per APA instructions to avoid or reduce cracking in the system.

SC-11 Cement Board Layout

These drawings relay the conceptual conditions of Master Wall® Systems and are not the construction drawings. Ultimately the design and detailing of an entire wall system is the responsibility of a professional. These details will guide the design professional in the use of Master Wall® Products. Master Wall disclaims design, warranty or construction intent or responsibility. Bold or Brand Name = Master Wall® Product. ©2020 Master Wall Inc.®

Stucco Cement Board Coating System Detail

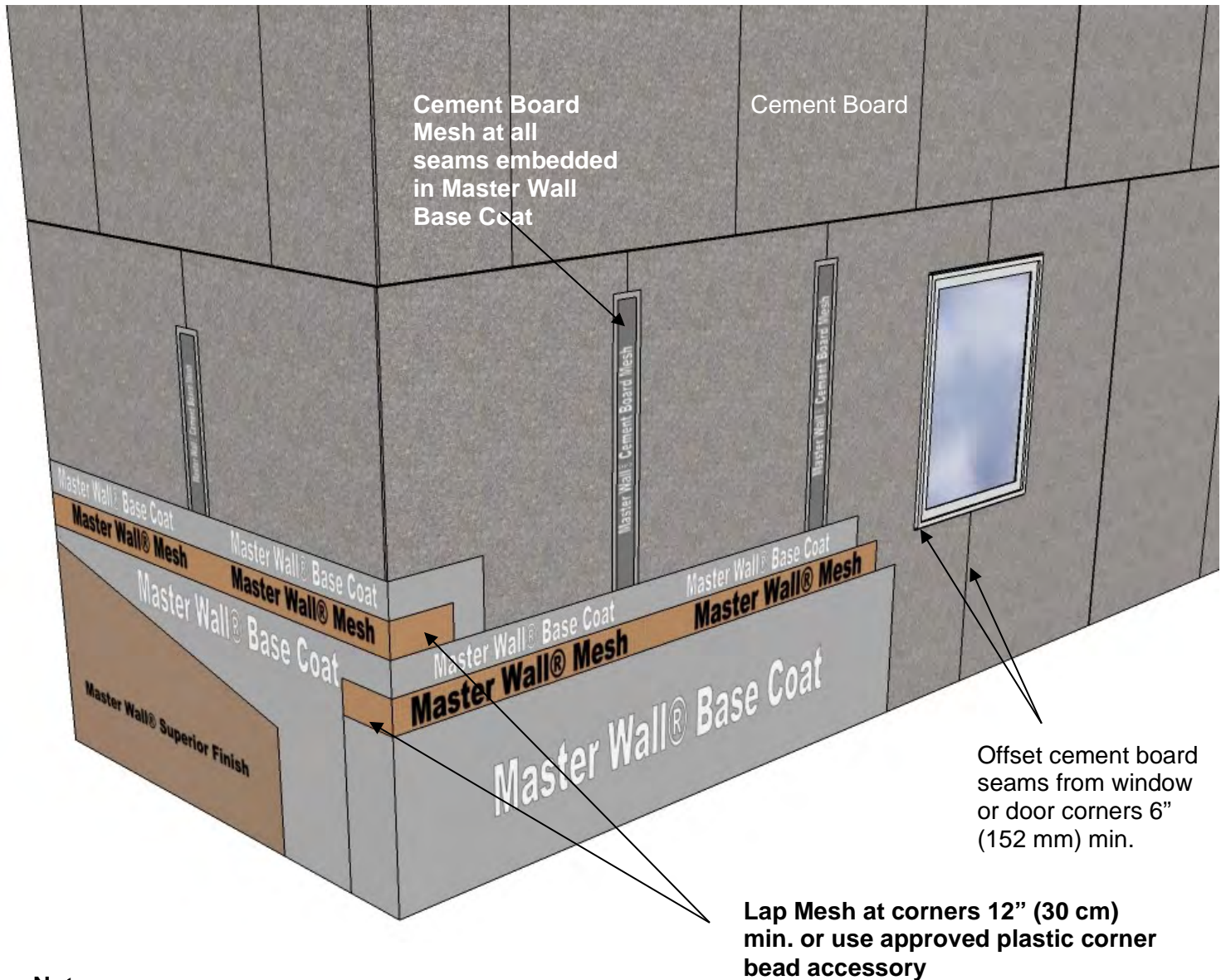

Notes

- Overlap mesh seams 2-1/2" (63.5 mm) min.

SC-12 Mesh Layout

These drawings relay the conceptual conditions of Master Wall® Systems and are not the construction drawings. Ultimately the design and detailing of an entire wall system is the responsibility of a professional. These details will guide the design professional in the use of Master Wall® Products. Master Wall disclaims design, warranty or construction intent or responsibility. Bold or Brand Name = Master Wall® Product. ©2020 Master Wall Inc.®

Stucco Cement Board Coating System Detail

Head Flashing with End Dams and sealed lower edge. Lap water barrier onto flashing.



SC-13 Window Head with Flashing

These drawings relay the conceptual conditions of Master Wall® Systems and are not the construction drawings. Ultimately the design and detailing of an entire wall system is the responsibility of a professional. These details will guide the design professional in the use of Master Wall® Products. Master Wall disclaims design, warranty or construction intent or responsibility. Bold or Brand Name = Master Wall® Product. ©2020 Master Wall Inc.®

Stucco Cement Board Coating System Detail

Sealant joint sized for anticipated movement, 3/8" (9.5 mm) min.

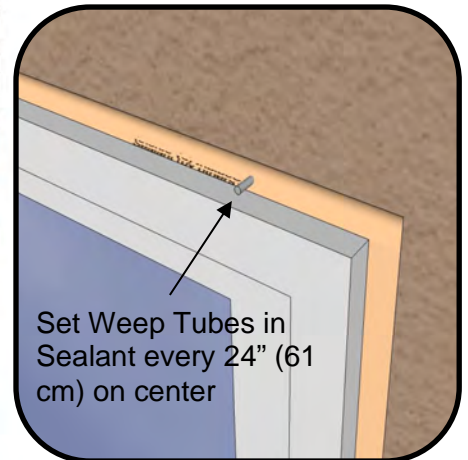
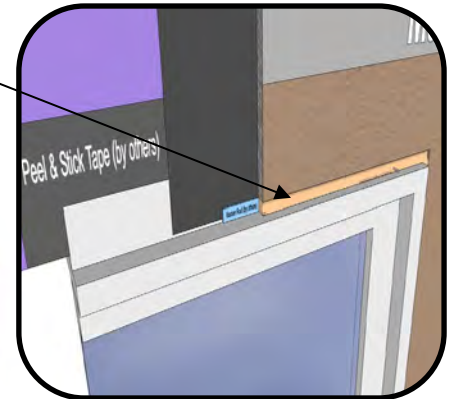

SC-14 Self-Flashing Window Head

These drawings relay the conceptual conditions of Master Wall® Systems and are not the construction drawings. Ultimately the design and detailing of an entire wall system is the responsibility of a professional. These details will guide the design professional in the use of Master Wall® Products. Master Wall disclaims design, warranty or construction intent or responsibility. Bold or Brand Name = Master Wall® Product. ©2020 Master Wall Inc.®

Stucco Cement Board Coating System Detail

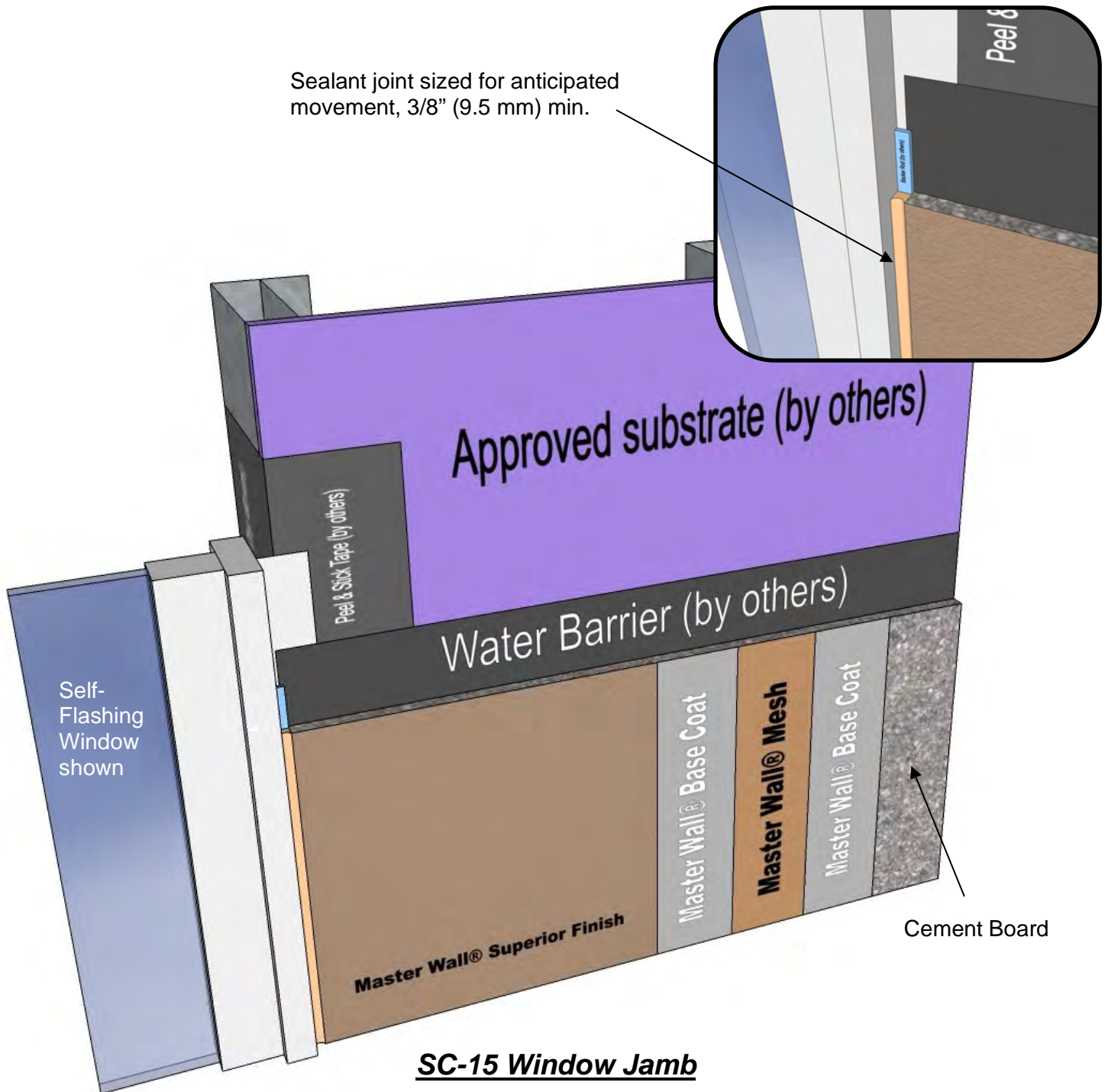

These drawings relay the conceptual conditions of Master Wall® Systems and are not the construction drawings. Ultimately the design and detailing of an entire wall system is the responsibility of a professional. These details will guide the design professional in the use of Master Wall® Products. Master Wall disclaims design, warranty or construction intent or responsibility. Bold or Brand Name = Master Wall® Product. ©2020 Master Wall Inc.®

Stucco Cement Board Coating System Detail



Sealant joint sized for anticipated movement, 3/8" (9.5 mm) min.

SC-16 Window Sill

These drawings relay the conceptual conditions of Master Wall® Systems and are not the construction drawings. Ultimately the design and detailing of an entire wall system is the responsibility of a professional. These details will guide the design professional in the use of Master Wall® Products. Master Wall disclaims design, warranty or construction intent or responsibility. Bold or Brand Name = Master Wall® Product. ©2020 Master Wall Inc.®

Stucco Cement Board Coating System Detail

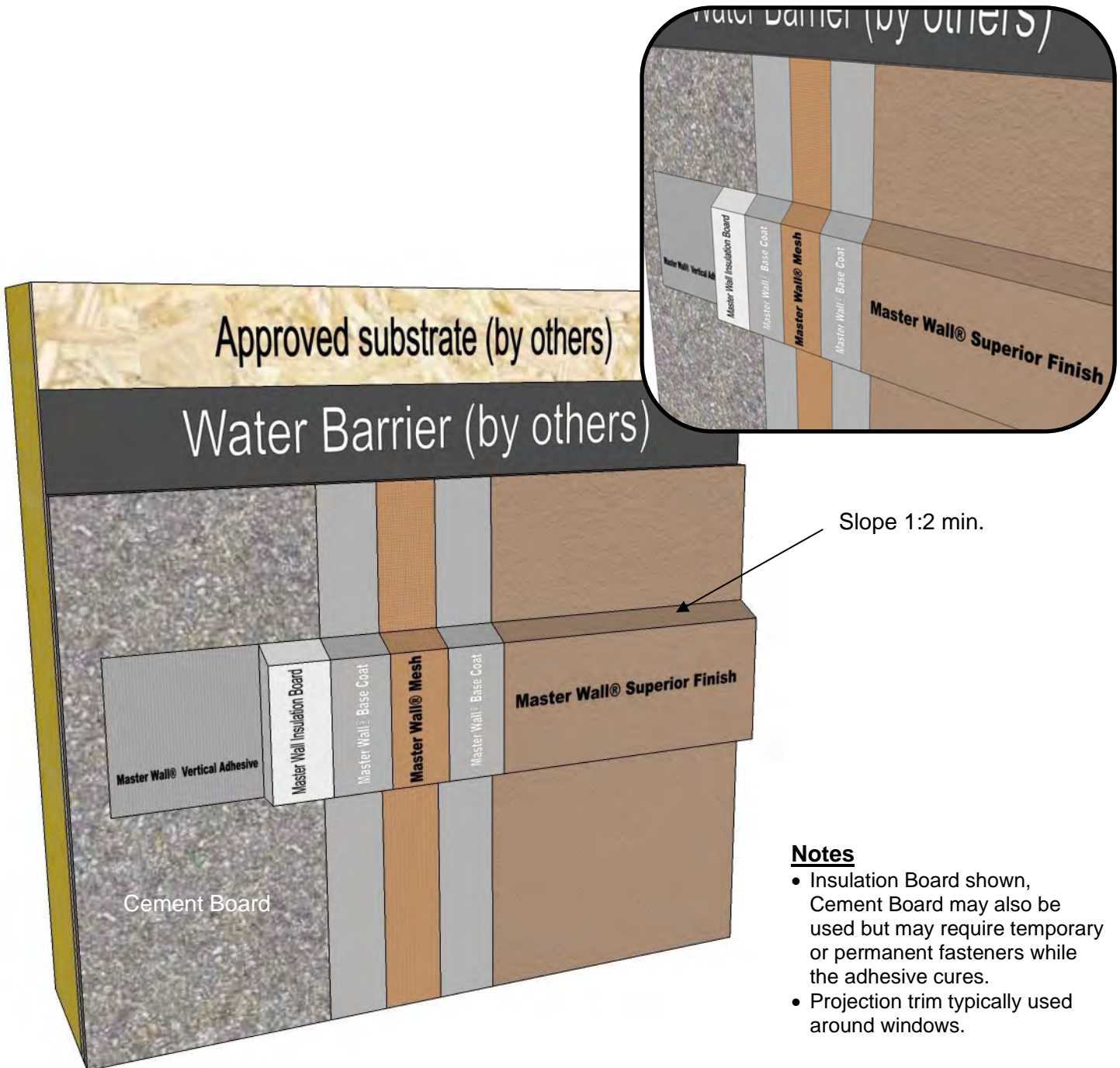

Notes

- Insulation Board shown, Cement Board may also be used but may require temporary or permanent fasteners while the adhesive cures.
- Projection trim typically used around windows.

SC-17 Aesthetic Projection

These drawings relay the conceptual conditions of Master Wall® Systems and are not the construction drawings. Ultimately the design and detailing of an entire wall system is the responsibility of a professional. These details will guide the design professional in the use of Master Wall® Products. Master Wall disclaims design, warranty or construction intent or responsibility. Bold or Brand Name = Master Wall® Product. ©2020 Master Wall Inc.®

Stucco Cement Board Coating System Detail

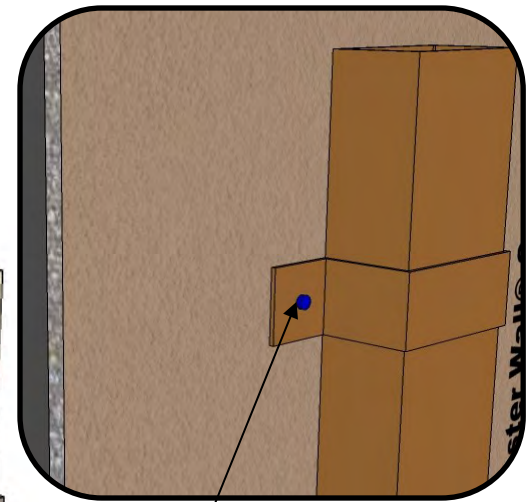

Fastener and Strap set in Sealant – Snug Tighten Only

Notes

- Fasten gutter straps to structural support such as a bearing substrate or structural support (by others)

SC-18 Downspout Attachment

These drawings relay the conceptual conditions of Master Wall® Systems and are not the construction drawings. Ultimately the design and detailing of an entire wall system is the responsibility of a professional. These details will guide the design professional in the use of Master Wall® Products. Master Wall disclaims design, warranty or construction intent or responsibility. Bold or Brand Name = Master Wall® Product. ©2020 Master Wall Inc.®

Stucco Cement Board Coating System Detail

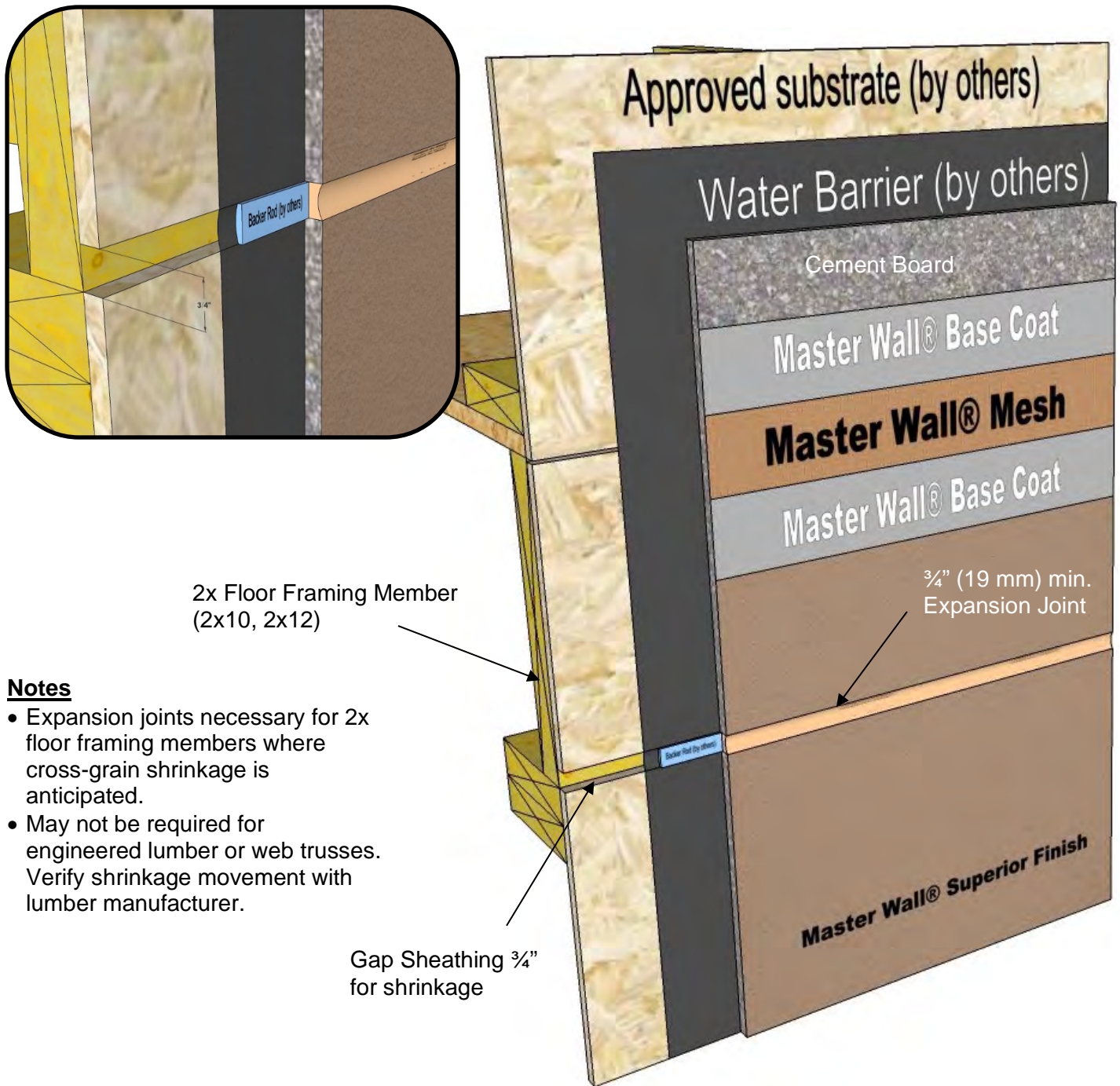

Notes

- Expansion joints necessary for 2x floor framing members where cross-grain shrinkage is anticipated.
- May not be required for engineered lumber or web trusses. Verify shrinkage movement with lumber manufacturer.

SC-19 Floor Line Expansion Joint

These drawings relay the conceptual conditions of Master Wall® Systems and are not the construction drawings. Ultimately the design and detailing of an entire wall system is the responsibility of a professional. These details will guide the design professional in the use of Master Wall® Products. Master Wall disclaims design, warranty or construction intent or responsibility. Bold or Brand Name = Master Wall® Product. ©2020 Master Wall Inc.®

Stucco Cement Board Coating System Detail



SC-20 Dissimilar Materials (Vertical)

These drawings relay the conceptual conditions of Master Wall® Systems and are not the construction drawings. Ultimately the design and detailing of an entire wall system is the responsibility of a professional. These details will guide the design professional in the use of Master Wall® Products. Master Wall disclaims design, warranty or construction intent or responsibility. Bold or Brand Name = Master Wall® Product. ©2020 Master Wall Inc.®

Stucco Cement Board Coating System Detail



Notes

- Shown with separate flashing means and water barriers.
- Continuous water barrier applications with a single drainage means could use a 3/8" (9.5 mm) min. sealant joint in lieu of flashing.

SC-21 Dissimilar Materials (Horizontal)

These drawings relay the conceptual conditions of Master Wall® Systems and are not the construction drawings. Ultimately the design and detailing of an entire wall system is the responsibility of a professional. These details will guide the design professional in the use of Master Wall® Products. Master Wall disclaims design, warranty or construction intent or responsibility. Bold or Brand Name = Master Wall® Product. ©2020 Master Wall Inc.®

Stucco Cement Board Coating System Detail

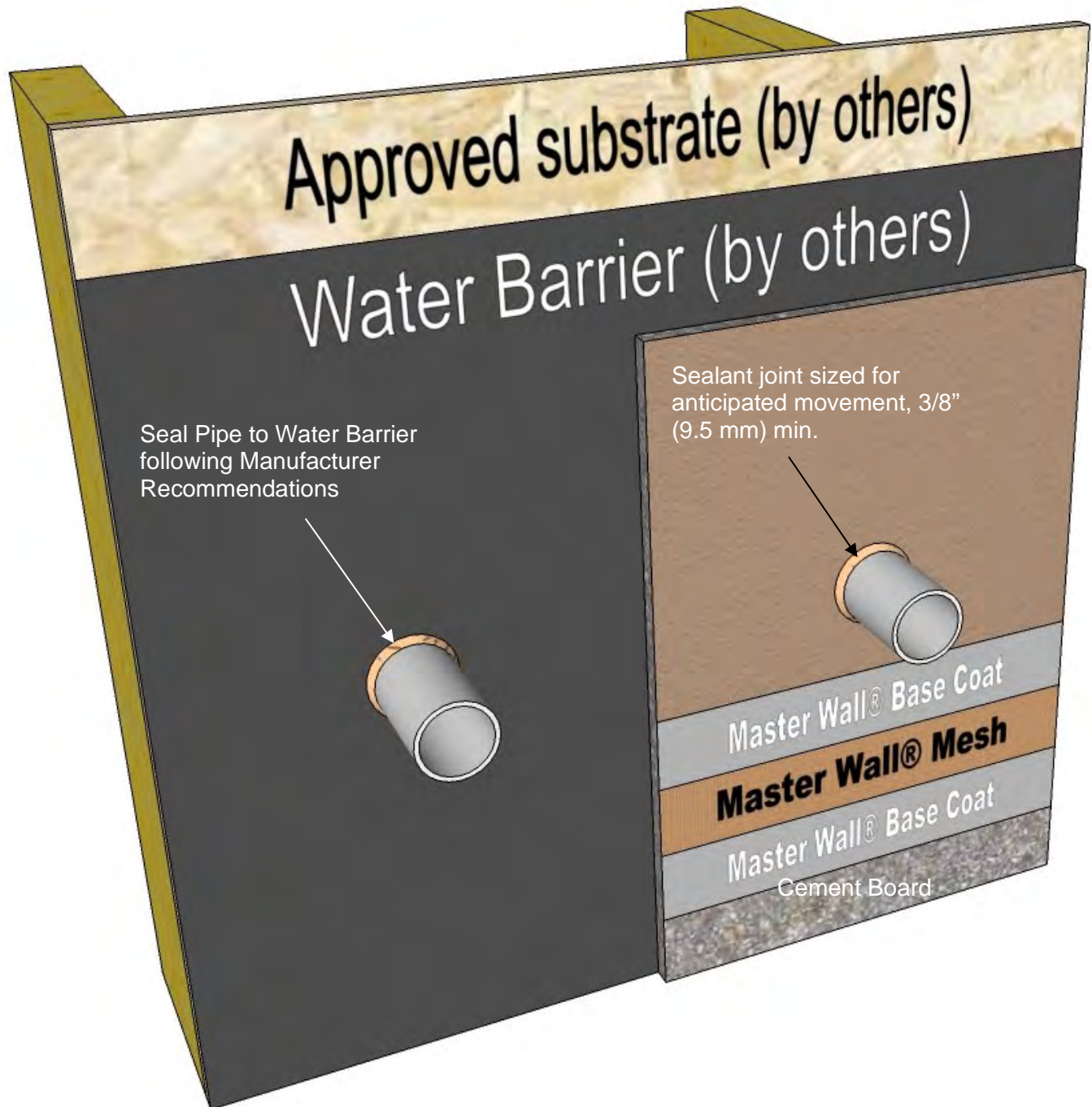

SC-22 Pipe Penetration

These drawings relay the conceptual conditions of Master Wall® Systems and are not the construction drawings. Ultimately the design and detailing of an entire wall system is the responsibility of a professional. These details will guide the design professional in the use of Master Wall® Products. Master Wall disclaims design, warranty or construction intent or responsibility. Bold or Brand Name = Master Wall® Product. ©2020 Master Wall Inc.®

Stucco Cement Board Coating System Detail

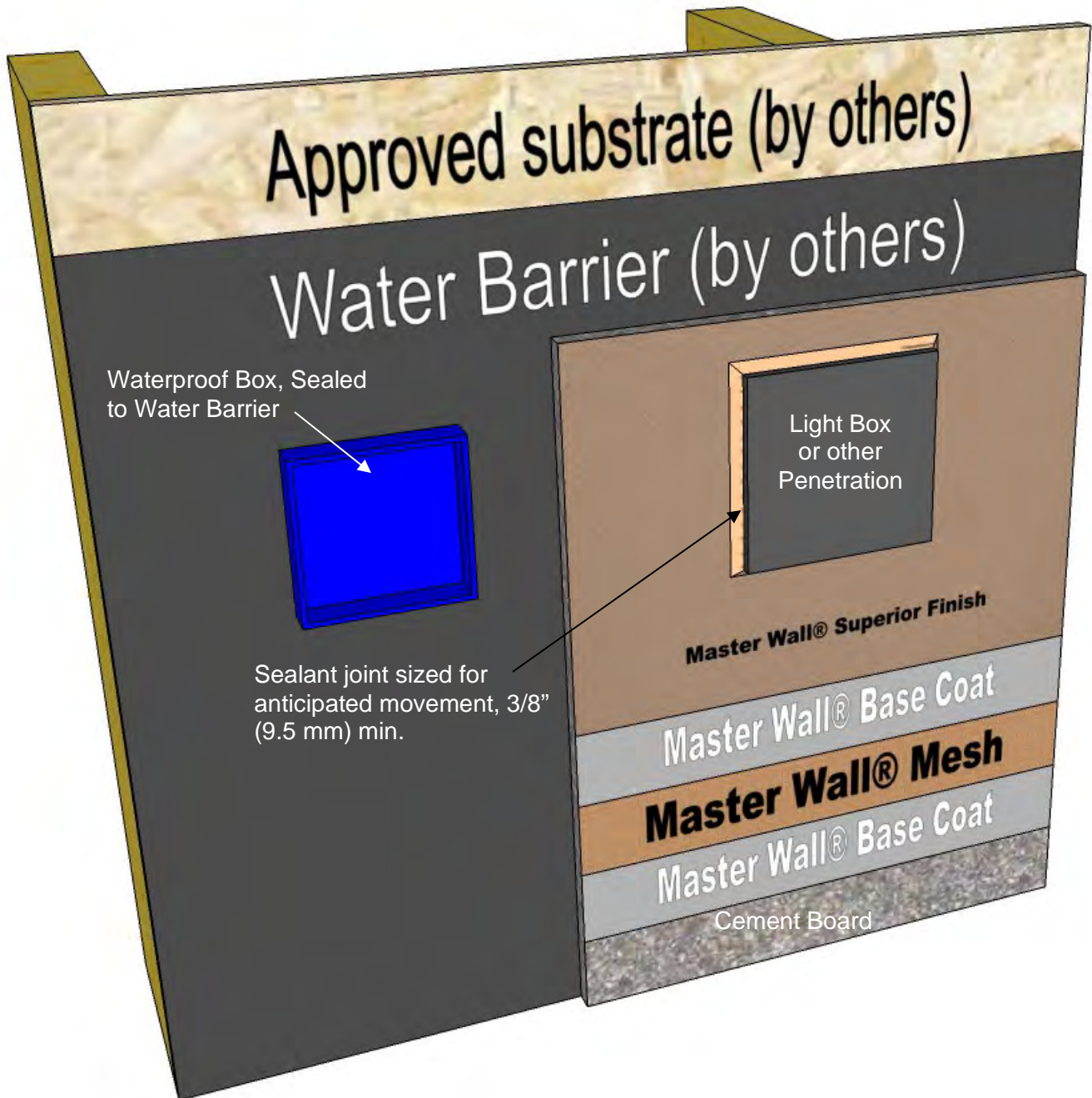

SC-22 Light Fixture or Other Penetration

These drawings relay the conceptual conditions of Master Wall® Systems and are not the construction drawings. Ultimately the design and detailing of an entire wall system is the responsibility of a professional. These details will guide the design professional in the use of Master Wall® Products. Master Wall disclaims design, warranty or construction intent or responsibility. Bold or Brand Name = Master Wall® Product. ©2020 Master Wall Inc.®

Stucco Cement Board Coating System Detail

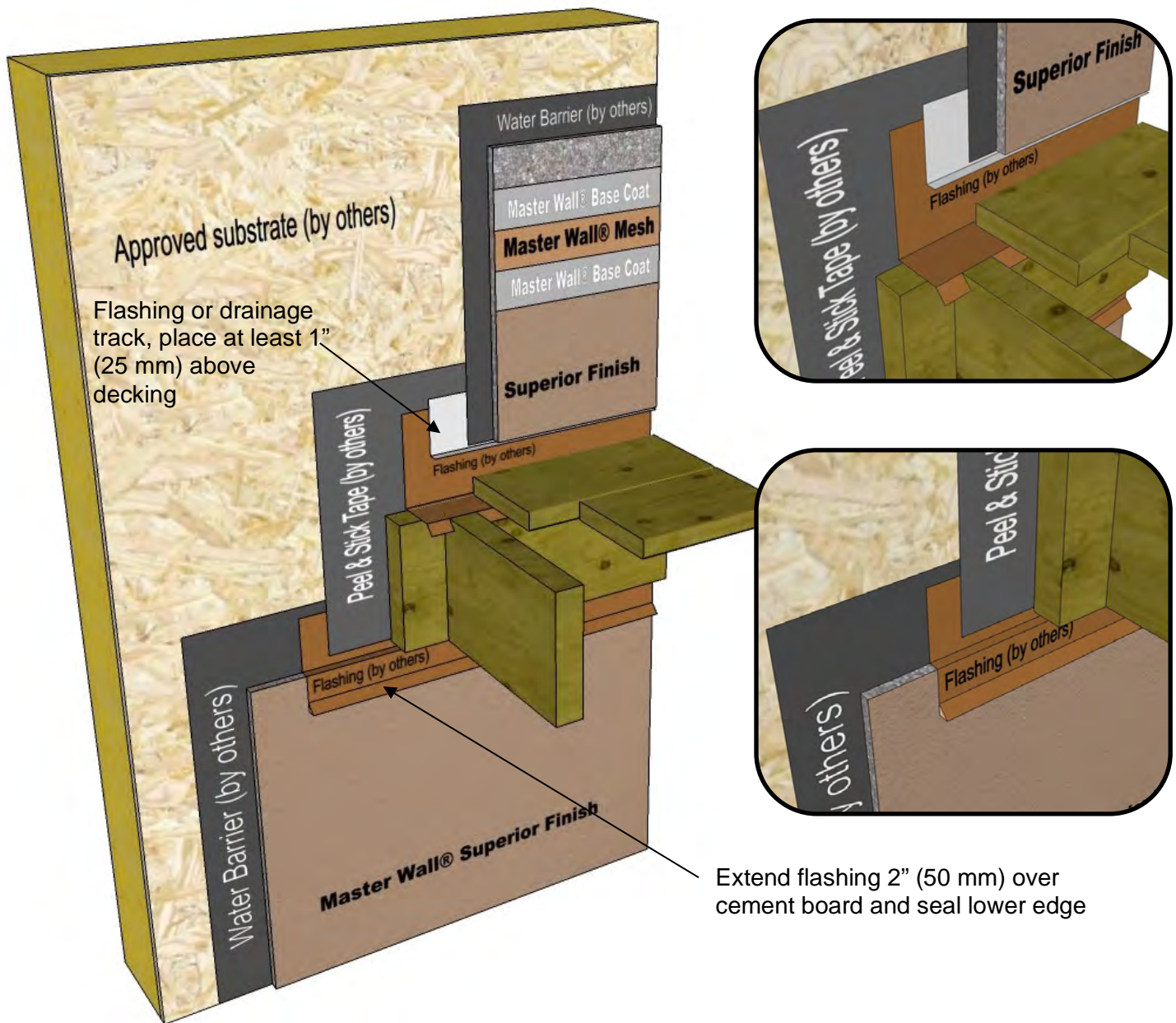

SC-24 Deck Flashing

These drawings relay the conceptual conditions of Master Wall® Systems and are not the construction drawings. Ultimately the design and detailing of an entire wall system is the responsibility of a professional. These details will guide the design professional in the use of Master Wall® Products. Master Wall disclaims design, warranty or construction intent or responsibility. Bold or Brand Name = Master Wall® Product. ©2020 Master Wall Inc.®

Stucco Cement Board Coating System Detail



SC-25 Detail at Soffit

These drawings relay the conceptual conditions of Master Wall® Systems and are not the construction drawings. Ultimately the design and detailing of an entire wall system is the responsibility of a professional. These details will guide the design professional in the use of Master Wall® Products. Master Wall disclaims design, warranty or construction intent or responsibility. Bold or Brand Name = Master Wall® Product. ©2020 Master Wall Inc.®

Stucco Cement Board Coating System Detail

Roof Cap with Continuous Cleat and secondary weather protection, extend 2" (50 mm) onto Cement Board and seal lower edge

Treated Nailer flush with Cement Board

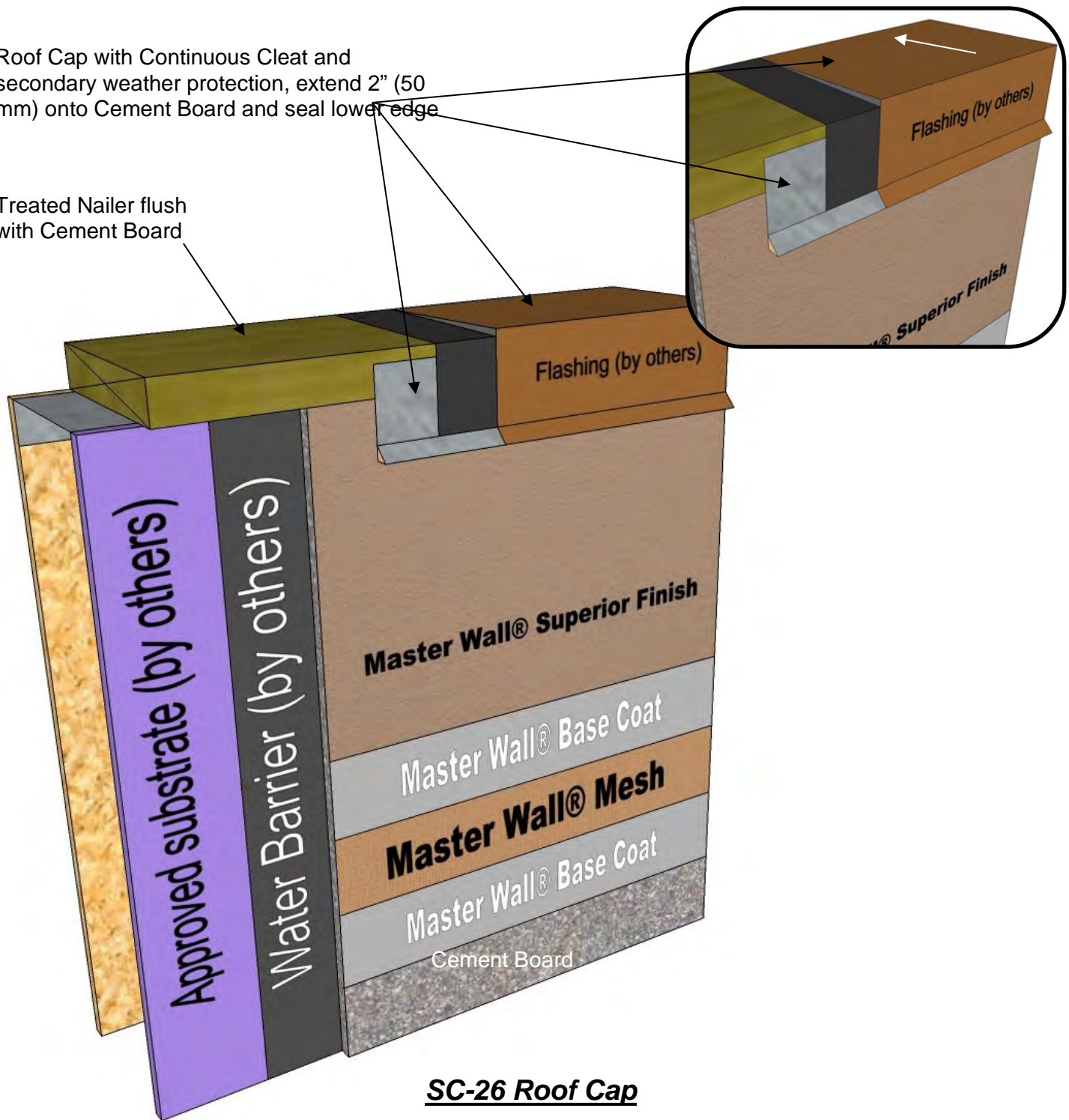

SC-26 Roof Cap

These drawings relay the conceptual conditions of Master Wall® Systems and are not the construction drawings. Ultimately the design and detailing of an entire wall system is the responsibility of a professional. These details will guide the design professional in the use of Master Wall® Products. Master Wall disclaims design, warranty or construction intent or responsibility. Bold or Brand Name = Master Wall® Product. ©2020 Master Wall Inc.®

Stucco Cement Board Coating System Detail

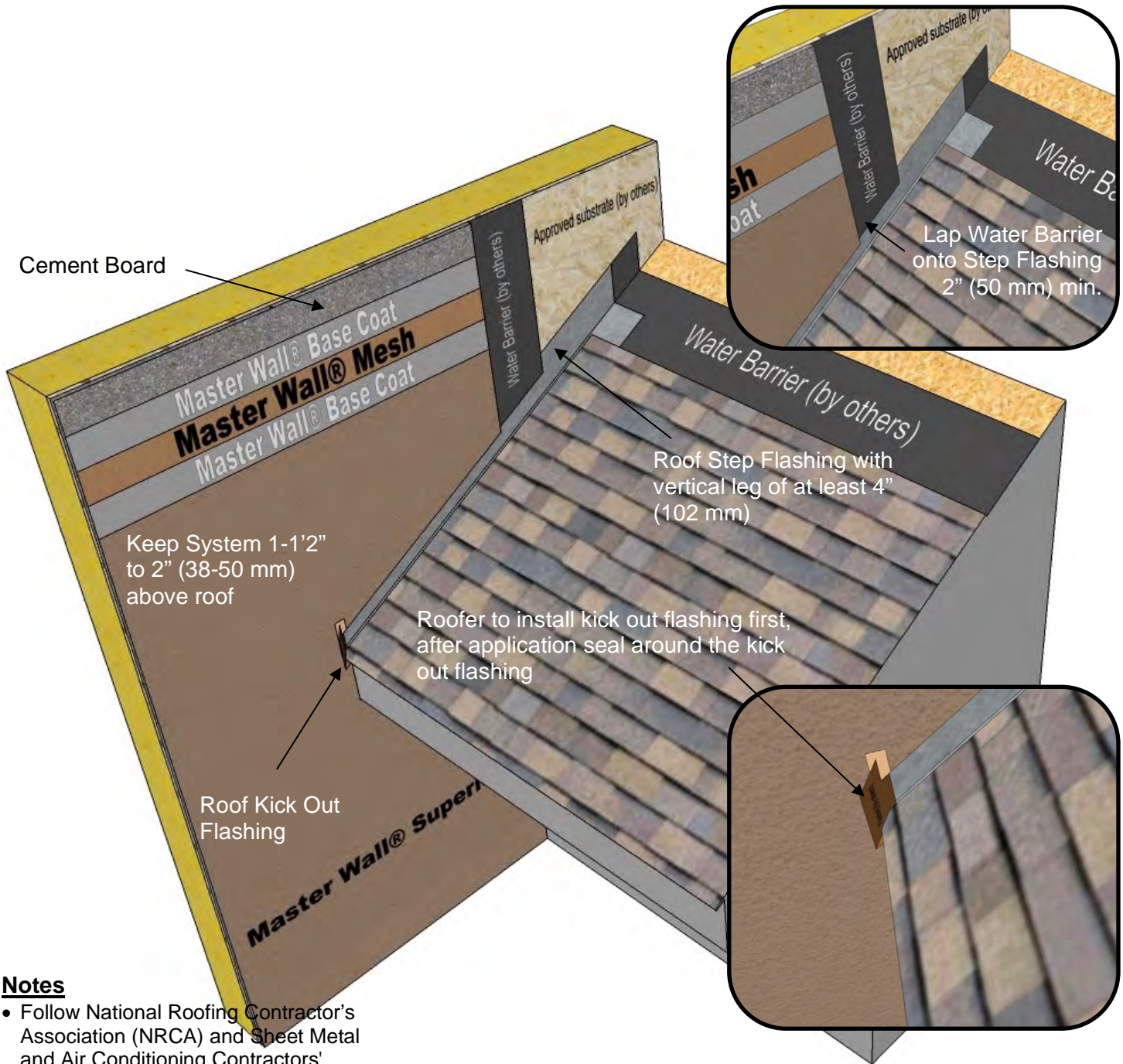

Notes

- Follow National Roofing Contractor's Association (NRCA) and Sheet Metal and Air Conditioning Contractors' National Association (SMACNA) requirements when installing roofing and flashing materials

SC-27 Roof/Wall Kick Out

These drawings relay the conceptual conditions of Master Wall® Systems and are not the construction drawings. Ultimately the design and detailing of an entire wall system is the responsibility of a professional. These details will guide the design professional in the use of Master Wall® Products. Master Wall disclaims design, warranty or construction intent or responsibility. Bold or Brand Name = Master Wall® Product. ©2020 Master Wall Inc.®