

# Project Submittal Package



Project:  
Location:  
Architect:  
General Contractor:  
Applicator:



## Master Wall Inc.®



[System Data Sheets](#)   [Product Data Sheets](#)   [Sample Warranty](#)  
[Specifications](#)   [Details](#)   [Web Link \(click here\)](#)

PO Box 397

Fortson

GA

31808

800-755-0825

[masterwall.com](http://masterwall.com)



# Aggre-flex System

07 24 13

Class PB Exterior Insulation and Finish System

## Features & Benefits

- High Insulating Value (R-4 per inch)
- Design Flexibility
- Medium Impact Resistance is standard

## System Use

- Commercial

## Attachment Method

- Mechanical
- Adhesive

Master Wall Inc.® Aggre-flex System is a polymer-based (Class PB) Exterior Insulation and Finish System (EIFS) that blankets commercial projects in a layer of protective insulation reducing thermal losses at framing members and better insulating the entire building.

The Aggre-flex System offers many options from its weather-resistant monolithic exterior to design flexibility and ease of design. It has the visual appeal that architects and owners look for without the weight or expense of traditional materials.

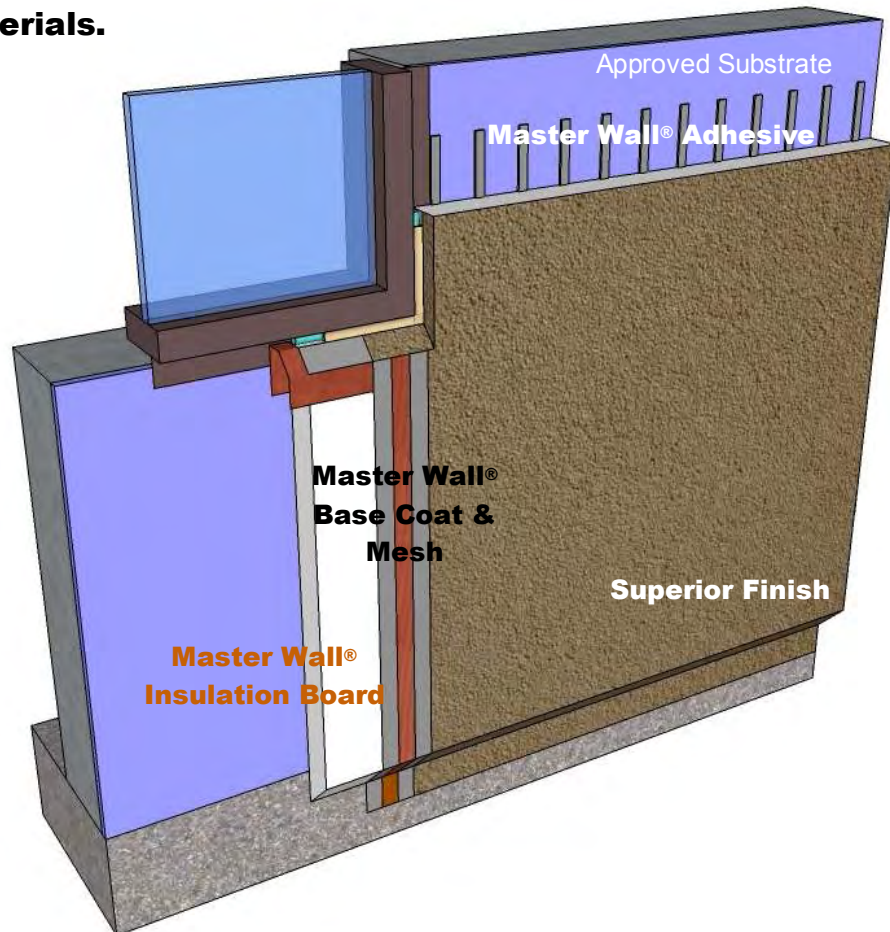

**M** Master Wall Inc.®  
*Building a Culture of Excellence*

[masterwall.com](http://masterwall.com)

PO Box 397 • Fortson • GA • 31808 • 800-755-0825 • Tech: 800-760-2861



# Aggre-flex System

## Short Form Specification

### 1.0 General

This is a short form specification. Refer to Aggre-flex specifications and details for additional information.

#### 1.1 System Description

The Master Wall Inc.® Aggre-flex Exterior Insulation and Finish System (EIFS) is a Class PB (Polymer Based) EIF System consisting of mechanical or adhesive attachment, insulation board, reinforcing mesh and a textured finish.

#### 1.2 Design Requirements:

- A. Reference Master Wall® suggested details and architectural drawings for specific detail requirements.
- B. Slope all surfaces a minimum of 1:2 (6" in 12") to shed water, maximum 12" (305 mm) wide.
- C. Maximum deflection of substrates shall not exceed L/240.
- D. Typical acceptable substrates include unpainted brick, masonry, concrete, Portland cement plaster (stucco), exterior grade gypsum sheathing (ASTM C1396), Glass Fiber Sheathing (ASTM C1177), CDX exterior grade plywood, Exposure 1 Oriented Strand Board (OSB). Contact Master Wall® for other approved substrates.
- E. Expansion joints are required at building expansion joints, panel joints, floor lines in wood framed construction, and other areas where significant movement occurs.

#### 1.3 Quality Assurance

- A. The Aggre-flex System shall be recognized by local building codes.
- B. The system shall meet or exceed ASTM C1397 and detailed in accordance with ASTM E2511.
- C. The system shall have been tested for fire performance in accordance with ASTM E108, ASTM E-84, NFPA 265, and NFPA 268.
- D. The system shall have been tested for water resistance in accordance with ASTM E331, IBC 12 (Section 1403.2).

#### 1.4 Job Conditions

- A. Store all materials protected from weather and direct sunlight at temperatures above 40°F (5°C).
- B. The ambient and wall temperature shall be a minimum of 40°F (5°C) and shall remain so for at least 24 hours after installation.

### 2.0 Products

All components of the Aggre-flex System shall be manufactured by Master Wall Inc.® and supplied by an authorized distributor.

- A. Master Wall® Adhesives & Fasteners:
  1. Foam & Mesh Adhesive (F&M), F&M Plus: A 100% pure acrylic-based adhesive that is field mixed with Portland cement.
  2. Master Wall® Bagged Base (MBB), MBB Plus: A ready to use dry base that is field mixed with water.
  3. Guardian: A waterproof 100% pure acrylic-based fiber reinforced adhesive that is field mixed with Portland cement.
  4. Fastener: Wind-Lock Wind Devil 2 washer and appropriate fastener or approved equal.
- B. Master Wall® Insulation Board: Molded Expanded Polystyrene insulation board manufactured to Master Wall specifications.
- C. Aggre-flex Mesh: Available in Standard, Detail, Hi-Tech, Medium, Strong and Ultra.
- D. Master Wall® Base Coats:
  1. Foam & Mesh Adhesive (F&M), F&M Plus.
  2. Master Wall® Bagged Base (MBB), MBB Plus.
  3. Guardian.
- E. Superior Finish: 100% pure acrylic formulation with integral color and texture. Perfect, Spray, Desert Sand, R-Coarse and Refinish textures.
- F. Specialty Finishes: Specialty finish blends of natural and man-made decorative specialty finishes and accents.
- G. Master Wall® Coatings:
  1. Primecoat: A water-based primer.
  2. Sanded Primecoat: Sanded water-based primer.
  3. Roller-flex: A water-based architectural finish coating.

### 3.0 Installation

- A. Inspect the substrate to ensure that it is free of all foreign materials that would affect the adhesion or attachment of the Aggre-flex System.
- B. Apply the system in strict accordance with Master Wall® specifications, product data sheets, architectural drawings and architectural specifications.

**We finish strong.**

Information contained in this product data sheet conforms to the standard detail recommendations and specifications for the installation of Master Wall Inc.® products and is presented in good faith. Master Wall Inc.® assumes no liability, expressed or implied as to the architecture, engineering, or workmanship of any project. This information may be concurrent with, or superseded by other applicable documents, such as specifications and details. Contact Master Wall Inc.® for the most current product information. ©2014 Master Wall Inc.®

 **Master Wall Inc.®**  
*Building a Culture of Excellence*  
**masterwall.com**

**PO Box 397 • Fortson • GA • 31808 • 800-755-0825 • Tech: 800-760-2861**

## Master Wall® Insulation Board – Type I

Master Wall® Insulation Board is a high performance insulation material that is used to wrap the entire building to keep interior temperatures more consistent. It helps to reduce thermal bridging at framing members and is easy to cut, rasp and place. It may be custom formed into various decorative shapes. Packaged in 144 board foot bundles, each bundle weights approximately 12 lbs (5.44 kg) and is available in flat or drainage configurations.

### Packaging/Shelf Life/Storage

Packaging: 144 board foot bundles\*

Coverage by Thickness:

**3/4"** (19.2 mm): 24 pcs, 192 sf (17.84 sm)

**1"** (25.2 mm): 18 pcs, 144 sf (13.38 sm)

**1-1/2"** (38.2 mm): 12 pcs, 96 sf (8.92 sm)

**2"** (50.8 mm): 9 pcs, 72 sf (6.69 sm)

**3"** (76.2 mm): 6 pcs, 48 sf (4.46 sm)

**4"** (101.6 mm): 5 pcs, 40 sf (3.72 sm)

\*Varies by manufacturer facility

Board thickness:

Maximum 4" (102mm)

Minimum 3/4" (19.1mm)

Drainage Board 1.5" (38.2 mm)+

Board width, max.: 24" (610mm)

Board length, max.: 48" (1219mm)

### Technical Data

Meets or Exceeds ASTM C578, ASTM C273, ASTM E2430, ASTM E2568.

ASTM C578, Type I, Wall Specification Grade

Minimum Density: 0.90 pcf

R-Value (U-Value) at 75°F (9°C): 3.8 (0.28) per inch thickness

Compressive strength, min., PSI (kPa): 10.0 (69)

Tensile strength min., PSI (kPa): 15.0 (103)

Flexural Strength, min., PSI (kPa) : 25.0 (172)

Water Vapor Permeance of 1.00 in (25.2 mm) thickness, max., perm (ng/Pa.s.m<sup>2</sup>): 5.0 (287)

Water absorption by total immersion, max., volume, % : 4.0

Dimensional stability (change in dimensions), max., %: 2.0

Oxygen index, min., volume, %: 24.0

Flame spread, max.: 25.0

Smoke development, max. 450

For a full listing of approved manufacturers please reference the insulation board page at [masterwall.com](http://masterwall.com)

### Features & Benefits

- Continuous Insulation for Wall Assemblies
- Easily cut into shapes for decorative trim
- Reduces air movement in wall
- Reduces life cycle CO2 emissions
- Controls dew point / moisture condensation in wall
- Long lasting, strong, stable
- Contains no CFC, HCFC, HFC or formaldehyde
- Recyclable
- Cost effective

Flat Insulation Board

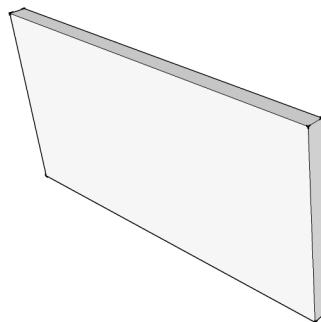

Wavy Insulation Board

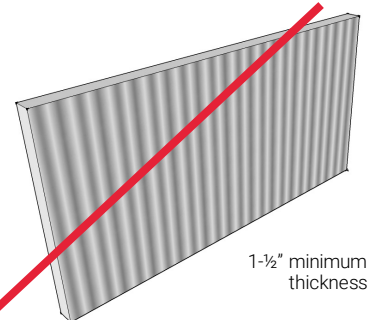

Grooved Insulation Board

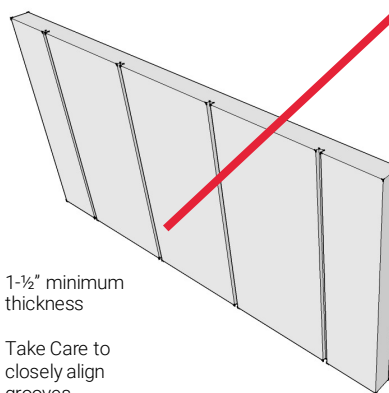

Attachment Methods

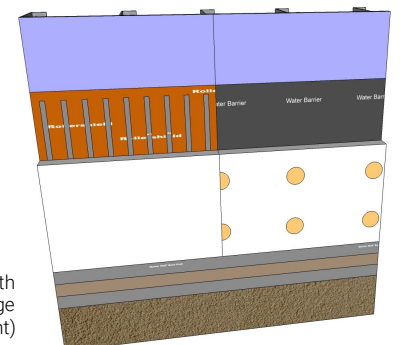

Systems Shown: Rollershield Drainage EIFS with adhesive attachment (Left), Aggre-flex Drainage with mechanical attachment (Right)

## Master Wall® Insulation Board – Type I

### Application Procedure

Job Conditions - Follow directions on adhesive data sheets. Mechanical attachment of insulation boards may be performed at lower temperatures over a dry surface.

Temporary Protection – Provide temporary and permanent protection to prevent water entry behind the system.

Substrate Preparation – Applications must be to an approved substrate with a maximum variation tolerance of 1/4" in 10'-0" (6.4 mm in 3.05m). Contact Master Wall for approved substrates and recommended attachment methods.

### Application

The Insulation Board can be easily cut using handsaws, power saws, sharp knives, or thermal cutting tools. Rasping of the Insulation Board is completed with 12 grit sandpaper, manually or with air or electric rasping machines.

Follow data sheet recommendations for adhering insulation board to approved substrates. For mechanical attachment, fasten the Insulation Board to the approved substrate using Wind-Lock Wind-Devil 2 or other approved plastic plates. See Master Wall System Details for more information. Fastening patterns shall be determined by the requirements of the geographical conditions of the area, local code requirements, and the performance of the fasteners, retainers and their test results in conjunction with the specified substrate and the thickness of insulation board specified for use. Minimum 1" (25.2 mm) thickness for mechanically attached systems.

Install insulation board on the wall according to specification requirements. For further information and details, see the Master Wall System Application Instructions.

### Limitations

The minimum required thickness for insulation board in the Master Wall Aggre-flex EIF System and Rollershield Drainage CIFS® is 3/4" (19.2 mm) at any location on the wall.

Insulation board shall not be used in interior applications.

Residential applications require a secondary water barrier with the option of flat insulation board with profiled water barriers or drainage insulation board. See Aggre-flex Drainage Details for insulation board construction. Product description information and basic uses etc.

Information contained in this product data sheet conforms to the standard detail recommendations and specifications for the installation of Master Wall Inc.® products and is presented in good faith. Master Wall Inc.® assumes no liability, expressed or implied as to the architecture, engineering, or workmanship of any project. This information may be concurrent with, or superseded by other applicable documents, such as specifications and details. Contact Master Wall Inc.® for the most current product information. ©2020 Master Wall Inc.®



**masterwall.com**

## Fasteners and Plates for **Aggre-flex** & Aggre-flex Drainage CIFS®

Master Wall® Continuous Insulation and Finish Systems (CIFS® or EIFS) use a variety of fasteners and plates when mechanically attaching the insulation board to or through a substrate.

All fastening systems must be applied according to Master Wall instructions. Please reference the system detail drawings and specifications for approved fastening methods and call Master Wall for any special conditions or questions.

### Approved Fasteners

Minimum zinc coated screw of the type needed for the substrate. Wind-Lock Economy Zinc, Premium Climacoat® or approved equal.

### Approved Plastic Plates

BeroXpert: Original PB™ Washer  
 Buildex: Gridmate PB  
 Demand Products: PB Washer, PBH Washer, Gridmaster Washer  
 EJOT Fastening Systems LP: EJOT® SBH-T fastening system (includes fastener)  
 Wind-Lock: Wind Devil 2

### Countersunk Insulated Fastener System

EJOT Fastening Systems LP:  
 • ejotherrm® STR H W  
 • ejotherrm® STR H S

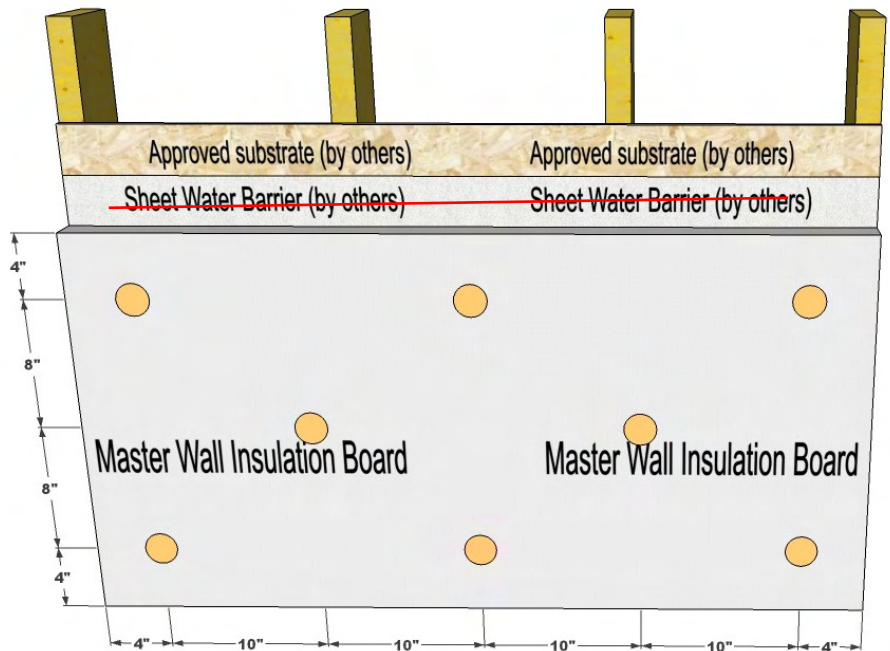

### Available Substrates

- Wood
- Plywood
- Oriented Strand Board (OSB)
- Masonry/Concrete
- Metal

### Aggre-flex Systems Plate Examples



Metric: 4"=102 mm, 8"=204 mm, 10"=254 mm, 16"=406 mm

Information contained in this product data sheet conforms to the standard detail recommendations and specifications for the installation of Master Wall Inc.® products and is presented in good faith. Master Wall Inc.® assumes no liability, expressed or implied as to the architecture, engineering, or workmanship of any project. This information may be concurrent with, or superseded by other applicable documents, such as specifications and details. Contact Master Wall Inc.® for the most current product information. ©2020 Master Wall Inc.®



[masterwall.com](http://masterwall.com)

PO Box 397 • Fortson • GA • 31808 • 800-755-0825

## Fasteners and Plates for Aggre-flex & Aggre-flex Drainage CIFS®

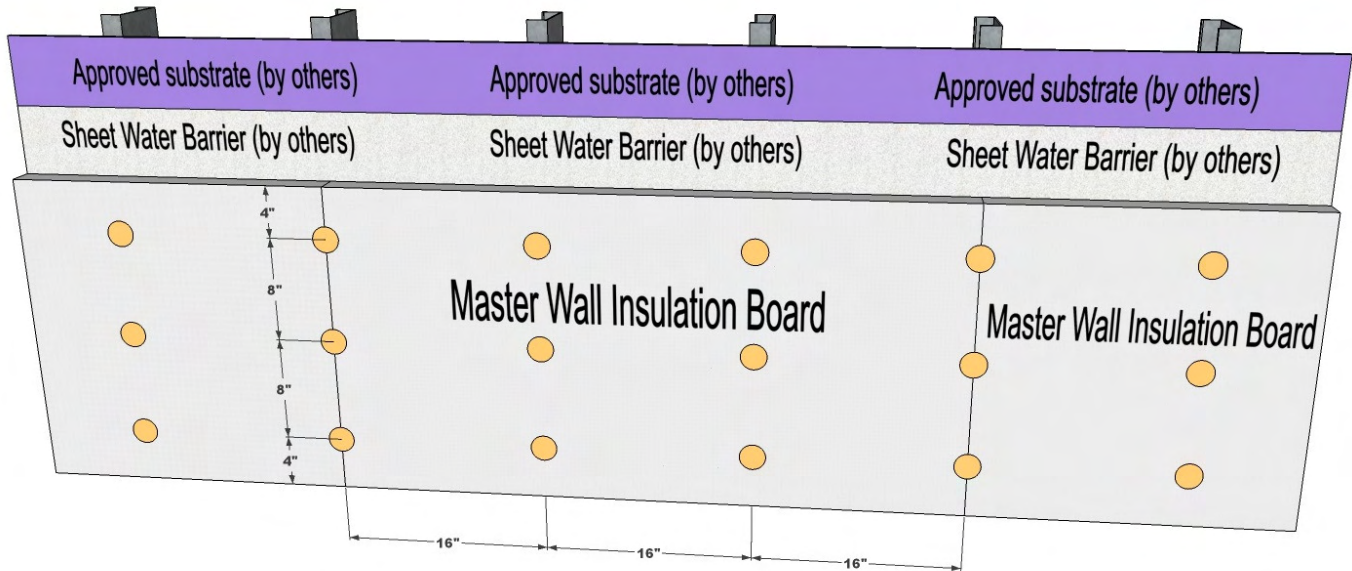

### Non-Nailable Substrates

- Gypsum

## Fastener Length Calculator for EIFS

Fastener Type	Insulation Thickness*	Sheathing Thickness	Minimum Penetration	Total Length	Available Sizes (Courtesy Wind-Lock)
Wood		Gypsum ½" to 5/8"	3/4"		1-5/8", 2", 2-1/2", 3", 3-3/4", 4-1/2"
Wood		Plywood ½" to ¾"	1/4"		1-5/8", 2", 2-1/2", 3", 3-3/4", 4-1/2"
Light Metal		25ga min.	1/4"		1-5/8", 2-1/4", 2-5/8", 3", 4", 4-1/2"
Steel		Gypsum ½" to 5/8"	1/4"		1-5/8", 2", 2-5/8", 3", 3-3/4", 4-3/8", 5", 6", 7", 8"
Masonry		1" to 1-3/4" (Pre-drill hole ½" deeper than fastener penetration)			1-3/4", 2-1/4", 2-3/4", 3-1/4", 4"

\*1" to 4" for Aggre-flex EIFS

Information contained in this product data sheet conforms to the standard detail recommendations and specifications for the installation of Master Wall Inc.® products and is presented in good faith. Master Wall Inc.® assumes no liability, expressed or implied as to the architecture, engineering, or workmanship of any project. This information may be concurrent with, or superseded by other applicable documents, such as specifications and details. Contact Master Wall Inc.® for the most current product information. ©2020 Master Wall Inc.®



**masterwall.com**

PO Box 397 • Fortson • GA • 31808 • 800-755-0825



**Master Wall Inc.®**  
Building a Culture of Excellence

## PRODUCT DATA

### F&M ADHESIVE AND BASE COAT

Foam & Mesh Adhesive (F&M) is a 100% acrylic formulated high performance base coat and adhesive used in Master Wall® Systems or over prepared substrates including brick, masonry, concrete and stucco.

### FEATURES & BENEFITS

- Adheres insulation board to approved substrates
- Base coat for Master Wall CIFS®, EIFS and other Systems
- Leveling coat for Cemplaster Fiberstucco and other stucco products
- Excellent water resistance
- Mixes 1:1 with Portland cement to a creamy consistency
- 100% Acrylic Polymers for durability
- Water-based - easy clean up with water

Application Temperature: 40°-110°F (5°-43°C)

Working Time: 1 hour

Set Time: Varies with temperature and humidity

Dry Time: 12 hours at room temperature, working and drying time will vary with temperature and humidity.

### JOB CONDITIONS

Air and substrate temperature for application of F&M must be 40°F (5°C) or higher and must remain 40°F (5°C) or higher for a minimum of 24 hours. Provide temporary protection to protect the wall system from damage until permanent flashings, caps and sealants are installed. Store materials within prescribed temperature limits and out of direct sunlight. Working and drying times are based upon normal room temperature conditions and will vary with temperature and humidity.

### PREPARATION

The substrate must be approved by Master Wall Inc.®, clean, dry, structurally sound and free of efflorescence, oil, grease, form release agents and curing compounds or anything that would affect bond. Painted surfaces are generally unacceptable without evaluation. Reference Technical Bulletins #173 and #187 for additional information.

### Coverage per pail (sf/sm)\*

Adhesive & Standard Base Coat:  
120 sf (11 sm)

Embedding Single-layer of Mesh:  
240-280 sf (22-26 sm)

Double Layer of Mesh:  
80-230 sf (7.5-21 sm)

Notched Trowel Adhesive Application:  
135 sf (12.5 sm)

*\*All coverage is approximate and depend upon substrate, details and individual application*

### Packaging/Shelf Life/Storage

Packaging: 5 gallon (19L) pail

Pail Weight: 60 lbs (27 kg)

Shelf Life: 2 years

Storage: Protect from extreme heat - 90°F (32°C) and above, freezing and direct sunlight.

### Technical Data

ASTM C297/E2134 - min 30 psi (208 kPa)

ASTM D897 - min 22 psi (152 kPa) ASTM  
D2247 - Pass

ASTM E84 - Pass

ASTM E96 - 12 perms

ASTM E331 - Pass to 12.0 psf (575 Pa)

ASTM E2485/EIMA 101.01\* - Pass NFPA  
268\* - Pass

NFPA 285 (UBC 26-9)\* - Pass

\*part of a larger assembly

## APPLICATION PROCEDURE

Mixing - Thoroughly stir F&M using a heavy duty 1/2" (12.7 mm) drill at 400 to 500 rpm and a heavy duty mixing paddle. Pour half of the stirred F&M into a clean plastic pail. Add Type I or I-II Portland cement to the half pail of F&M in a ratio of one-to-one by weight and mix to a homogenous consistency. Let the mixture stand for 3 to 5 minutes and then stir to a creamy consistency. Up to 30 ounces (0.9L) of clean, potable water may be added to a half pail to adjust workability. Do not over mix as faster setting or reduced working time can occur. Do not add accelerators or retarders to the F&M mixture.

## APPLICATION

**ADHESIVE APPLICATION** – Over gypsum or Rollershield coated substrates, apply the F&M mixture directly to the back of the insulation board using a 3/8" x 3/8" x 3/8" (9.5 x 9.5 x 9.5 mm) or a 3/8" x 1/2" x 1-1/2" (9.5 x 13 x 38 mm) stainless steel notched trowel. With the trowel at a 45-degree angle, cover the entire back of the insulation board with full beads of adhesive. Apply the adhesive so the ribbons run vertically when applied to the wall.

Over non-gypsum substrates where drainage is not required, you may use the above described notched trowel method or the 'ribbon and dab' method. Using a stainless steel plastering trowel, apply a 2" (50.8 mm) wide by 3/8" (9.5 mm) high ribbon of the F&M mixture around the entire perimeter of the insulation board. Place 8 dabs of the F&M mixture 3/8" (9.5 mm) thick by 4" (102 mm) in diameter approximately 8" (204 mm) on center inside the ribbon.

Immediately place the prepared insulation board on the substrate. Make sure that all edges of the insulation board are abutted tightly and that no F&M mixture gets into the board joints. Do not allow the F&M mixture to form a skin prior to placing the insulation board on the substrate. Do not apply the F&M mixture directly onto the substrate.

**BASE COAT APPLICATION** – Over insulation board, all imperfections in the board must be rasped flush and any gaps in the insulation board must be filled with slivers of insulation. Apply the F&M mixture over the entire surface of the insulation board in a thickness greater than that of the reinforcing fabric being used (approximately 1/16" (1.6 mm) for standard mesh and 3/32" (2.4 mm) for Ultra Mesh). Immediately embed the reinforcing fabric into the wet F&M mixture and smooth from the center to the edge to avoid wrinkles. The reinforcing fabric must be continuous at all corners and lapped or abutted in accordance with Master Wall® specifications. The color of the mesh shall not be visible, but a slight mesh pattern may be visible.

As a leveling coat over approved concrete, masonry, stucco, and other surfaces, apply the F&M mixture over the entire surface a nominal 1/16" (1.6 mm) thick. Where reinforcing mesh is specified, follow application methods for insulation board above.

**Hazard:** This chemical is not considered hazardous according to the OSHA Hazard Communication Standard 2012 (29 CFR 1910.1200).

**VOC:** Less than 50 g/L.

### Approved Substrates

Exterior gypsum sheathing  
(ASTM C1396, C1177)

Dens Glass Gold®  
GlasRoc®  
FiberBond®  
Gold Bond e2xp®  
Securock®  
Weather Defense Platinum™

Cement Board (ASTM C1325)  
Durock®  
PermaBase®  
Util-A-Crete®  
ProTEC®, ProGUARD®

Concrete  
Brick  
Masonry  
Metal Lath - Adhesive Application  
Adheres to Rollershield  
Others approved in writing

## CLEAN UP

Tools and equipment can be cleaned with soapy water while the F&M is still wet.

### WARNING, THIS PRODUCT CONTAINS SILICA

If sanding or scraping are performed, ventilate work area and/or use a NIOSH/MSHA-approved respirator in accordance with our Safety Data Sheet.

Information contained in this product data sheet conforms to the standard detail recommendations and specifications for the installation of Master Wall Inc.® products and is presented in good faith. Master Wall Inc.® assumes no liability, expressed or implied as to the architecture, engineering, or workmanship of any project. This information may be concurrent with, or superseded by other applicable documents, such as specifications and details. Contact Master Wall Inc.® for the most current product information. ©2022 Master Wall Inc.®



## Health & Safety

### WARNING!

Causes eye and skin irritation.  
Precautionary Statement

Wash hands thoroughly after handling. Wear protective gloves/protective clothing/eye protection/face protection.

### FIRST AID MEASURES

**Eye Contact:** Immediately flush eyes with plenty of water for at least 15 to 20 minutes. Ensure adequate flushing of the eyes by separating the eyelids with fingers. Get immediate medical attention.

**Skin Contact:** Immediately wash skin with plenty of soap and water for 15 to 20 minutes, while removing contaminated clothing and shoes. Get medical attention if irritation develops or persists.

**Inhalation:** If inhaled, remove to fresh air. If not breathing, give artificial respiration or give oxygen by trained personnel. Seek immediate medical attention.

**Ingestion:** If swallowed, do NOT induce vomiting. Call a physician or poison control center immediately. Never give anything by mouth to an unconscious person.

Store locked up. Dispose of contents/container in accordance with Local, State, Federal and Provincial regulation.

**Spills:** Collect with suitable absorbent material such as cotton rags.

**Disposal:** Dispose of in accordance with local, state or federal regulations.

Warning: KEEP CONTAINER CLOSED WHEN NOT IN USE. KEEP OUT OF THE REACH OF CHILDREN. NOT FOR INTERNAL CONSUMPTION. FOR INDUSTRIAL USE ONLY.

Consult the Safety Data Sheet (SDS) in the Products section at [masterwall.com](http://masterwall.com) for further health and safety information.

### LIMITED WARRANTY

This product is subject to a written limited material or system warranty. Obtain a warranty from the Tech Support tab of our website. Refer to Specifications for more complete information on proper use and handling of this product.



**Master Wall Inc.®**  
Building a Culture of Excellence

## PRODUCT DATA

### MBB

Master Wall® Bagged Base Coat (MBB) is a dry polymer acrylic formulated high performance base coat and adhesive used in Master Wall® Systems or over prepared substrates including brick, masonry, concrete and stucco.

### FEATURES & BENEFITS

- Adheres insulation board to approved substrates
- Base coat for Master Wall CIFS®, EIFS and other Systems
- Leveling coat for Cemplaster Fiberstucco and other stucco products
- Excellent water resistance
- Freeze stable in dry form
- Convenient, mixes with water
- Easy clean up with water

Application Temperature: 40°-110°F (5°-43°C)

Working Time: 1 hour

Set Time: Varies with temperature and humidity

Dry Time: 12 hours at room temperature, working and drying time will vary with temperature and humidity.

### JOB CONDITIONS

Air and substrate temperature for application of MBB must be 40°F (5°C) or higher and must remain 40°F (5°C) or higher for a minimum of 24 hours. Provide temporary protection to protect the wall system from damage until permanent flashings, caps and sealants are installed. Store materials within prescribed temperature limits and out of direct sunlight. Working and drying times are based upon normal room temperature conditions and will vary with temperature and humidity.

### PREPARATION

The substrate must be approved by Master Wall Inc®., clean, dry, structurally sound and free of efflorescence, oil, grease, form release agents and curing compounds or anything that would affect bond. Painted surfaces are generally unacceptable without evaluation. Reference Technical Bulletins #173 and #187 for additional information.

### Coverage per bag (sf/sm)\*

Adhesive & Standard Base Coat:

50-60 sf (4.6-5.36 sm)

Embedding Single-layer of Mesh:

100-125 sf (9-11.5 sm)

Double Layer of Mesh:

30-110 sf (2.5-10 sm)

Notched Trowel Adhesive Application:

56 sf (5.2 sm)

*\*All coverage is approximate and depend upon substrate, details and individual application*

### Packaging/Shelf Life/Storage

Packaging: 50lb (22.7kg) bag

Shelf Life: 1 year

Storage: Protect from weather, high humidity and direct sunlight.

### Technical Data

ASTM C297/E2134 - min 30 psi (208 kPa)

ASTM E96 - 12 perms

**APPLICATION PROCEDURE**

Mixing - Add 5 to 6 quarts (4.7-5.7L) of potable water to a clean plastic pail. Add the MBB slowly while stirring using a heavy-duty 1/2" (12.7mm) drill at 400 to 500 rpm and a heavy-duty Mixer. Mix thoroughly to a homogenous consistency. Let the mixture stand for 3 to 5 minutes and then stir to a creamy consistency. Small amounts of clean, potable water may be added to obtain a workable consistency. Do not over mix. Excessive stirring may cause faster setting and reduced working time. Do not add accelerators or retarders to the MBB mixture.

**APPLICATION**

*ADHESIVE APPLICATION* – Over gypsum or Rollershield coated substrates, apply the MBB mixture directly to the back of the insulation board using a 3/8" x 3/8" x 3/8" (9.5 x 9.5 x 9.5 mm) or a 3/8" x 1/2" x 1-1/2" (9.5 x 13 x 38 mm) stainless steel notched trowel. With the trowel at a 45-degree angle, cover the entire back of the insulation board with full beads of adhesive. Apply the adhesive so the ribbons run vertically when applied to the wall.

Over non-gypsum substrates where drainage is not required, you may use the above described notched trowel method or the 'ribbon and dab' method. Using a stainless steel plastering trowel, apply a 2" (50.8 mm) wide by 3/8" (9.5 mm) high ribbon of the F&M mixture around the entire perimeter of the insulation board. Place 8 dabs of the F&M mixture 3/8" (9.5 mm) thick by 4" (102 mm) in diameter approximately 8" (204 mm) on center inside the ribbon.

Immediately place the prepared insulation board on the substrate. Make sure that all edges of the insulation board are abutted tightly and that no F&M mixture gets into the board joints. Do not allow the MBB mixture to form a skin prior to placing the insulation board on the substrate. Do not apply the MBB mixture directly onto the substrate.

*BASE COAT APPLICATION* – Over insulation board, all imperfections in the board must be rasped flush and any gaps in the insulation board must be filled with slivers of insulation. Apply the MBB mixture over the entire surface of the insulation board in a thickness greater than that of the reinforcing fabric being used (approximately 1/16" (1.6 mm) for standard mesh and 3/32" (2.4 mm) for Ultra Mesh). Immediately embed the reinforcing fabric into the wet MBB mixture and smooth from the center to the edge to avoid wrinkles. The reinforcing fabric must be continuous at all corners and lapped or abutted in accordance with Master Wall® specifications. The color of the mesh shall not be visible, but a slight mesh pattern may be visible.

As a leveling coat over approved concrete, masonry, stucco, and other surfaces, apply the MBB mixture over the entire surface a nominal 1/16" (1.6 mm) thick. Where reinforcing mesh is specified, follow application methods for insulation board above.

Hazard: This chemical is not considered hazardous according to the OSHA Hazard Communication Standard 2012 (29 CFR 1910.1200).

VOC: Less than 50 g/L.

**Approved Substrates**

- Exterior gypsum sheathing (ASTM C1396, C1177)
- Dens Glass Gold®
- GlasRoc®
- FiberBond®
- Gold Bond e2xp®
- Securock®
- Weather Defense Platinum™
- Cement Board (ASTM C1325)
- Durock®
- PermaBase®
- Util-A-Crete®
- ProTEC®, ProGUARD®
- Concrete
- Brick
- Masonry
- Metal Lath - Adhesive Application
- Adheres to Rollershield
- Others approved in writing

## CLEAN UP

Tools and equipment can be cleaned with soapy water while the MBB is still wet.

### WARNING, THIS PRODUCT CONTAINS SILICA

If sanding or scraping are performed, ventilate work area and/or use a NIOSH/MSHA-approved respirator in accordance with our Safety Data Sheet.

Information contained in this product data sheet conforms to the standard detail recommendations and specifications for the installation of Master Wall Inc.® products and is presented in good faith. Master Wall Inc.® assumes no liability, expressed or implied as to the architecture, engineering, or workmanship of any project. This information may be concurrent with, or superseded by other applicable documents, such as specifications and details. Contact Master Wall Inc.® for the most current product information. ©2022 Master Wall Inc.®



## Health & Safety

### WARNING!

Causes eye and skin irritation.  
Precautionary Statement

Wash hands thoroughly after handling. Wear protective gloves/protective clothing/eye protection/face protection.

### FIRST AID MEASURES

**Eye Contact:** Immediately flush eyes with plenty of water for at least 15 to 20 minutes. Ensure adequate flushing of the eyes by separating the eyelids with fingers. Get immediate medical attention.

**Skin Contact:** Immediately wash skin with plenty of soap and water for 15 to 20 minutes, while removing contaminated clothing and shoes. Get medical attention if irritation develops or persists.

**Inhalation:** If inhaled, remove to fresh air. If not breathing, give artificial respiration or give oxygen by trained personnel. Seek immediate medical attention.

**Ingestion:** If swallowed, do NOT induce vomiting. Call a physician or poison control center immediately. Never give anything by mouth to an unconscious person.

**Storage:** Store locked up. Dispose of contents/container in accordance with Local, State, Federal and Provincial regulation.

**Spills:** Collect with suitable absorbent material such as cotton rags.

**Disposal:** Dispose of in accordance with local, state or federal regulations.

**Warning:** KEEP CONTAINER CLOSED WHEN NOT IN USE. KEEP OUT OF THE REACH OF CHILDREN. NOT FOR INTERNAL CONSUMPTION. FOR INDUSTRIAL USE ONLY.

Consult the Safety Data Sheet (SDS) in the Products section at [masterwall.com](http://masterwall.com) for further health and safety information.

### LIMITED WARRANTY

This product is subject to a written limited material or system warranty. Obtain a warranty from the Tech Support tab of our website. Refer to Specifications for more complete information on proper use and handling of this product.



**Master Wall Inc.®**  
Building a Culture of Excellence

## PRODUCT DATA

### AGGRE-FLEX MESH

Master Wall® Aggre-flex Mesh is a specially woven, glass fiber mesh with AR Coating (Alkali Resistive). Embedded in Master Wall® base coats, Aggre-flex Mesh is the key impact and tensile component in Master Wall® EIFS and wall systems. It can also improve crack resistance in Master Wall® Cemplaster Fiberstucco Systems, traditional stucco or foam shapes.

### FEATURES & BENEFITS

- **Detail Mesh** – super soft, pliable mesh used for backwrapping, special shapes, and detail work.
- **Standard Mesh**–Standard weight mesh for wall areas and general detailing. Industry leading impact resistance.
- **Hi-Tech Mesh**–Upgraded heavier weight version of Standard Mesh with good workability.
- **Medium Mesh**–Extra tough heavy weight mesh. Best for areas of light traffic.
- **Strong Mesh**–Great high traffic mesh where impacts are a consideration.
- **Ultra Mesh**–Best where abuse is expected. Ultra heavy for high traffic areas.
  - **Strong Mesh and Ultra Mesh** must be used in a two-layer system.
- **Corner Roll**– For highly impact resistant corners. Apply under Standard or higher mesh.

### MESH WEIGHT AND COVERAGE

	Mesh Weight	Roll Size	Coverage*
Detail	4.5 oz/sy (113 g/sm)	9.5" x 150' (96.5cm x 45.7m)	119 sf (11 sm)
Standard - 38	4.6 oz/sy (156 g/sm)	38" x 150' (96.5cm x 45.7m)	475 sf (44.1 sm)
Standard - 48	4.6 oz/sy (156 g/sm)	48" x 150' (122 cm x 45.7m)	600 sf (55.7 sm)
Hi-Tech	6.0 oz/sy (202 g/sm)	48" x 150' (122cm x 45.7m)	600 sf (55.7sm)
Medium	11.0 oz/sy (370 g/sm)	38" x 75' (96.5cm x 22.8m)	238 sf (22.1 sm)
Strong	15.4 oz/sy (508 g/sm)	38" x 75' (96.5cm x 22.8m)	238 sf (22.1 sm)
Ultra	21.0 oz/sy (700 g/sm)	48" x 75' (122cm x 22.8m)	300 sf (22.1 sm)
Corner Roll	9.5 oz/sy (238 g/sm)	9.5" x 150' (96.5cm x 45.7m)	150 lf (45.7 m)

\*Allow about 10% waste for lapping all meshes (Strong, Ultra and Corner Roll Meshes are butted). Coverage will vary.

### PRODUCT TEST STANDARDS

ASTM D76, ASTM D578, ASTM D579, ASTM D1777, ASTM D3659, ASTM D3775, ASTM D3776, ASTM D4029, ASTM D5035, ASTM E2098, ASTM E2486. MIL-Y-1140

Weave: Full Leno

### Impact ASTM E2486 (Formerly EIMA 101.86)

### ASTM D5035 Tensile (warp/fill)

Standard Mesh	Medium Impact Resistance 50-89 in-lbs (5.7-10.1J)	247/280
Hi Tech Mesh	Medium Impact Resistance 50-89 in-lbs (5.7-10.1J)	140/250
Medium Mesh	Medium Impact Resistance 50-89 in-lbs (5.7-10.1J)	300/500
Medium & Standard	High Impact Resistance 90-150 in-lbs (10.2-17.0J)	300/500
Strong & Standard	Ultra High Impact Resistance 150+ in-lbs (over17.0J)	350/600
Ultra & Standard	Ultra High Impact Resistance 150+ in-lbs (over17.0J)	750/500
Corner Roll		274/274

## APPLICATION PROCEDURE

Job Conditions - Air and substrate temperature for embedment of the Reinforcing Mesh must be 40°F (5°C) or higher and must remain 40°F (5°C) or higher for a minimum of 24 hours. Provide temporary protection at all times until the wall system, including flashings, caps, and sealants, is completed to provide protection from climatic conditions and other potential damage.

Application - All imperfections in the insulation board must be rasped flush and any gaps in the insulation board must be filled with slivers of insulation. Apply the base coat over the entire surface of the insulation board in a thickness greater than that of the Reinforcing Mesh being used, approximately 1/16" (1.6 mm) for Standard Mesh and 3/32" (2.4 mm) for Ultra Mesh. Immediately embed the Aggre-flex Mesh into the wet base coat and smooth from the center to the edge to avoid wrinkles. Lap all meshes except Strong Mesh and Ultra Mesh a minimum of 2-1/2" (63.5 mm) on all sides. The reinforcing fabric must be continuous at all corners and lapped or abutted in accordance to Master Wall specifications. The color of the mesh shall not be visible but a slight mesh pattern may be visible. The overall minimum thickness of the base coat should be a nominal 1/16" (1.6 mm) when dry.

When applying Strong, Ultra or Corner Roll Mesh, tightly abut all edges and let cure for a minimum of 12 hours. Grind any imperfections with the edge of a stainless steel trowel or grinding stone, taking care not to damage the Aggre-flex Mesh, and apply a layer of Standard Mesh, Hi-Tech Mesh, or Medium Mesh as per the directions in the preceding paragraph. To minimize wall variations, the lap of the second mesh layer should not coincide with the abutment of the first layer.

### Special Conditions and Recommendations

Apply wrapping, backwrapping mesh or other approved accessory at all terminations of the insulation board. This includes at the top and bottom of all walls and at all openings.

Aggre-flex Mesh may be wrapped from the face of the insulation board onto a foundation or onto the studs of an opening on barrier wall systems. In all cases, the exposed edges of the insulation board must be wrapped with Aggre-flex Mesh and base coat or an approved accessory trim.



## Health & Safety

### WARNING!

Causes eye and skin irritation.

Precautionary Statement

Wash hands thoroughly after handling. Wear protective gloves/protective clothing/eye protection/face protection.

Consult the Safety Data Sheet (SDS) in the Products section at [masterwall.com](http://masterwall.com) for further health and safety information.

### LIMITED WARRANTY

This product is subject to a written limited material or system warranty. Obtain a warranty from the Tech Support tab of our website. Refer to Specifications for more complete information on proper use and handling of this product.

Information contained in this product data sheet conforms to the standard detail recommendations and specifications for the installation of Master Wall Inc.® products and is presented in good faith. Master Wall Inc.® assumes no liability, expressed or implied as to the architecture, engineering, or workmanship of any project. This information may be concurrent with, or superseded by other applicable documents, such as specifications and details. Contact Master Wall Inc.® for the most current product information.  
©2022 Master Wall Inc.®



**Master Wall Inc.®**  
Building a Culture of Excellence

## PRODUCT DATA

### SUPERIOR FINISHES

To finish strong you need a Superior Finish. Master Wall® finishes are crafted with one of the highest 100% acrylic polymer contents in our industry. This translates to extra durability, lower life-cycle maintenance and a longer lasting finish.

### FEATURES & BENEFITS

- 100% Acrylic Polymers for durability
- Dirt Pickup Resistant (DPR) Polymer Formulation
- Quartz or Marble aggregate available
- 64 Standard Colors
- Custom color matching available
- DuroTone colorfast pigments, Excel mildew enhancement, Silicone Coat additive available
- Vapor Permeable - resists blistering and allows trapped water vapors to pass
- Low VOC—Suitable for Interior Use
- Water Based - easy clean up with water

Application Temperature: 40°-110°F (5°-43°C)

Working Time: 1/4 hr

Set Time: 8-12 hrs

Dry Time: 48-72 hrs at room temperature, working and drying time will vary with temperature and humidity.

### JOB CONDITIONS

Air and substrate temperature for application of Superior Finishes must be 40°F (5°C) or higher and must remain 40°F (5°C) or higher for a minimum of 24 hours. Provide temporary protection to protect the wall system from damage until permanent flashings, caps and sealants are installed. Store materials within prescribed temperature limits and out of direct sunlight. High temperatures will reduce working times, Low temperatures and/or high humidity and pigment loading will extend working, set and dry times.

### PREPARATION

The substrate must be approved by Master Wall Inc.®, clean, dry, structurally sound and free of efflorescence, oil, grease, form release agents and curing compounds or anything that would affect bond. Painted surfaces are not acceptable and must be removed. Concrete and surfaces should cure for a minimum of 28 days. Stucco should be cured until clean, dry and hard—typically 14 days with a pH of 10 or less (13 or less if Primecoat Primer is used).

Interior drywall should be finished and made ready for paint. Prime surfaces with Primecoat/Sanded Primecoat primer prior to finishing.

### Coverage per pail (sf/sm)\*

- Perfect Swirl 2.0, 120-150 (11-14)
- Fine Sand 1.0, 160-170 (15-15.8)
- Medium Sand 1.5, 130-150 (12-14)
- Versatex 0.5, Varies with Texture

*\*All coverage is approximate and depend upon substrate, details and individual application*

### Packaging/Shelf Life/Storage Packaging:

- 5 gallon (19L) pail Pail

Shelf Life: 2 years

Storage: Protect from extreme heat (90°F, 32°C), freezing and direct sunlight.

### Technical Data

ASTM B117 Salt Spray Resistance - Pass ASTM

C67 Freeze/Thaw - Pass

ASTM C297 Tensile Bond - 30 psi minimum

ASTM D968 Abrasion Resistance - Pass 500L

ASTM D2247/E2570 Water Resistance - Pass

ASTM D3273 Mildew Resistance - Pass 28 Days

ASTM E84 Surface Burning - Pass, FS=0, SD=0

ASTM E 96 Vapor Permeability - Pass, 12 perms, vapor open

ASTM E108 Flame Propagation - Pass

ASTM E2485/2570 (formerly EIMA 101.01)

Impact Resistance - Pass

ASTM G23/G154/G155 Accelerated Weathering - Pass 2000 Hours

ASTM G53 Accelerated Weathering - Pass 2000 Hours

## APPLICATION PROCEDURE

Base Coats - Must be flat, dry hard, and free of efflorescence. Master Wall® base coats must cure a minimum of 12 hours before application of Superior Finish. Substrates of brick, masonry or concrete should be leveled smooth using either Master Wall® base coats or stucco.

Mixing - Thoroughly stir Superior Finish using a heavy duty 1/2" drill at 400 - 500 rpm and a heavy duty mixing paddle. Small amounts of clean, potable water may be added to obtain a workable consistency. To avoid color variations, add the same amount of water to each pail. Do not exceed 24 ounces (0.7L) of water per pail of finish.

Application - Apply a uniform thickness (about 1/16", 1.6 mm) of Superior Finish to the substrate using a stainless steel trowel. Spread evenly and then scrape the finish coat down to a thickness no greater than the largest aggregate in the material. Immediately float the finish coat using a plastic float to the desired texture. Always maintain a wet edge to achieve uniformity of texture and color. Allow the finish to fully dry and set before exposure to inclement weather.

## FOR PROFESSIONAL RESULTS

Apply finish coats away from direct sunlight. Cold joints or color variations can occur if the finish dries too quickly. Priming stucco surfaces with Primecoat/Sanded Primecoat evens out finish absorption and should be strongly considered and specified for dark colored finishes, especially those using Ultra Deep Base (UDB) tint base and over stucco to avoid efflorescence blush. Under certain conditions dark colors may show efflorescence on the surface during the cure process.

Surfaces exposed to the weather must be sloped (6:12 minimum). Use of dark colors in high temperature climates can affect the performance of the system, especially EIFS and areas may need to be limited.

Deep, intense colors should be specified with DuroTone pigments to maintain colorfastness longer. Verify specialty colors with your Master Wall® Distributor. Finishes are intended for the approved substrates listed above and should not be applied directly to gypsum board or insulation board products.

## CLEAN UP

Tools and equipment can be cleaned with soapy water while the Superior Finish is still wet.

**Hazard:** This chemical is not considered hazardous according to the OSHA Hazard Communication Standard 2012 (29 CFR 1910.1200).

**VOC:** Less than 50 g/L.

See Superior Finishes for other technical properties

### Approved Substrates

Master Wall® Base Coats  
Cemplaster Fiberstucco, One Coat Stucco (OCS), Primecoat Primer surfaces, ASTM C926 Stucco

Prepared & Base Coated Surfaces of:  
Brick, Concrete, Masonry  
Others approved in writing

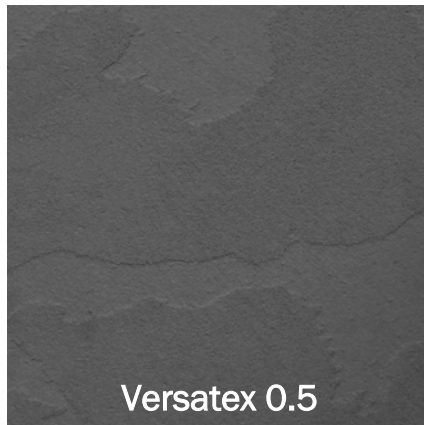
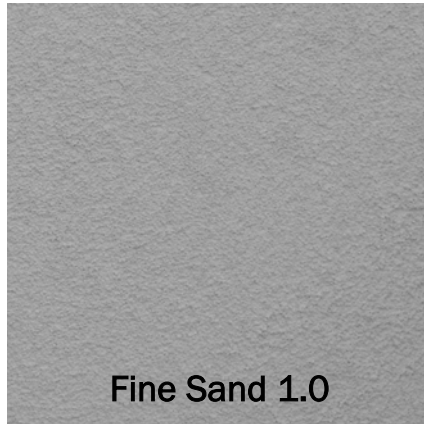

Information contained in this product data sheet conforms to the standard detail recommendations and specifications for the installation of Master Wall Inc.® products and is presented in good faith. Master Wall Inc.® assumes no liability, expressed or implied as to the architecture, engineering, or workmanship of any project. This information may be concurrent with, or superseded by other applicable documents, such as specifications and details. Contact Master Wall Inc.® for the most current product information. ©2022 Master Wall Inc.®



**Health & Safety**

**WARNING!**

Causes eye and skin irritation.  
 Precautionary Statement  
 Wash hands thoroughly after handling. Wear protective gloves/protective clothing/eye protection/face protection.

**FIRST AID MEASURES**

**Eye Contact:** Immediately flush eyes with plenty of water for at least 15 to 20 minutes. Ensure adequate flushing of the eyes by separating the eyelids with fingers. Get immediate medical attention.

**Skin Contact:** Immediately wash skin with plenty of soap and water for 15 to 20 minutes, while removing contaminated clothing and shoes. Get medical attention if irritation develops or persists.

**Inhalation:** If inhaled, remove to fresh air. If not breathing, give artificial respiration or give oxygen by trained personnel. Seek immediate medical attention.

**Ingestion:** If swallowed, do NOT induce vomiting. Call a physician or poison control center immediately. Never give anything by mouth to an unconscious person.

**Store locked up.** Dispose of contents/container in accordance with Local, State, Federal and Provincial regulation.

**Spills:** Collect with suitable absorbent material such as cotton rags.

**Disposal:** Dispose of in accordance with local, state or federal regulations.

**Warning:** KEEP CONTAINER CLOSED WHEN NOT IN USE. KEEP OUT OF THE REACH OF CHILDREN. NOT FOR INTERNAL CONSUMPTION. FOR INDUSTRIAL USE ONLY.

Consult the Safety Data Sheet (SDS) in the Products section at masterwall.com for further health and safety information.

**LIMITED WARRANTY**  
 This product is subject to a written limited material or system warranty. Obtain a warranty from the Tech Support tab of our website. Refer to Specifications for more complete information on proper use and handling of this product.



**Master Wall, Inc**  
**Building a Culture of Excellence**

# Aggre-flex EIFS

## 5 Year Labor & Material Limited Warranty

Master Wall Inc. warrants the properly designed and installed Aggre-flex system and materials for 5 years from the date of installation. Master Wall Inc.'s exclusive liability under this warranty is to supply replacement materials and labor or corrective procedures, if it is shown that the materials supplied by Master Wall Inc., were defective when installed by the Master Wall Inc. certified applicator. Remedies shall be solely determined by Master Wall Inc. and no other warranties are expressed or implied. For a valid warranty, the system and products must be installed in accordance with Master Wall Inc.'s written recommendations, specifications, details, bulletins and other project-specific written recommendations. Master Wall Inc. must be notified in writing within 10 business days of the original discovery of the defect.

Master Wall Inc., is not responsible for structural conditions, design conditions beyond those noted in our literature, architecture, engineering or workmanship of any project. Materials must be properly stored and applied in a timely manner. Workmanship, aesthetics and installation are beyond the scope of this warranty as are any deviations from Master Wall Inc. Documents not specifically approved in writing.

Abuse, misuse, excessive weather or environmental conditions beyond what the products or systems have been tested, designed or approved for is expressly limited. Certain colors with organic pigments are less fade-resistant than others. The building, system and products must be properly maintained in accordance with Master Wall Inc., documents, local environmental conditions and good building practices. In no case is Master Wall Inc. responsible for incidental and consequential damages.

**This warranty becomes effective only when all bills for the components of the system have been paid.**

**Except as stated, Master Wall, Inc., expressly disclaims any warranty of merchantability or fitness for a particular purpose. The above remedies are to be deemed exclusive.**

Project:

Applicator:

Warranty Date:

This is not the final warranty. For a valid warranty click on the support tab at [masterwall.com](http://masterwall.com) and request a warranty. Warranties are not valid until issued.



# Aggre-flex EIFS – Continuously Insulated Section 07 24 13



**Master Wall Inc.®**  
PO Box 397  
Fortson, GA 31808  
706-569-0092  
800-755-0825  
www.masterwall.com

## Master Wall Guide Specification AF Aggre-flex EIFS

### PART I – GENERAL

#### 1.01 SUMMARY

A. This document is to be used in preparing specifications for projects utilizing the Master Wall Inc.® Aggre-flex Class PB (polymer-based) Exterior Insulation and Finish System (EIFS) designed to provide continuous insulation for the wall assembly. Related Master Wall Inc.® documents:

1. Master Wall Inc.® Aggre-flex System Data Sheet
2. Master Wall Inc.® Aggre-flex System Application Instructions
3. Master Wall Inc.® Aggre-flex System Installation Details
4. Master Wall product data sheets

B. Related Sections

1. Unit Masonry – Section 04200
2. Concrete – Sections 03300 and 03400
3. Light Gauge Cold Formed Steel Framing – Section 05400
4. Wood Framing – Section 06100
5. Sealant – Section 07900
6. Flashing – Section 07600

#### 1.02 SUBMITTALS

- A. Manufacturer's specifications, details, installation instructions and product data
- B. Manufacturer's code compliance report
- C. Manufacturer's standard warranty
- D. Applicator's industry training credentials
- E. Samples for approval as directed by architect or owner
- F. Sealant manufacturer's certificate of compliance with ASTM C 1382
- G. Prepare and submit project-specific details (when required by contract documents)

#### 1.03 REFERENCES

A. ASTM Standards:

- ASTM B117 (Federal Test Standard 141A Method 6061) Standard Practice for Operating Salt Spray (Fog) Apparatus
- ASTM C150 Standard Specification for Portland Cement
- ASTM C297 Standard Test Method for Flatwise Tensile Strength of Sandwich Constructions
- ASTM C578 Specification for Preformed Cellular Polystyrene Thermal Insulation
- ASTM C1177 Standard Specification for Glass Mat Gypsum Substrate for Use as Sheathing
- ASTM C1396 (formerly C 79) Standard Specification for Gypsum Board
- ASTM D968 (Federal Test Standard 141A Method 6191) Standard Test Methods for Abrasion Resistance of Organic Coatings by Falling Abrasive



## Aggre-flex EIFS – Continuously Insulated Section 07 24 13

- ASTM D1784 Specification for Rigid Poly (Vinyl Chloride) (PVC) and Chlorinated Poly (Vinyl Chloride) (CPVC) Compounds
- ASTM D2247 (Federal Test Standard 141A Method 6201) Standard Practice for Testing Water Resistance of Coatings in 100% Relative Humidity
- ASTM D3273 Standard Test Method for Resistance to Growth of Mold on the Surface of Interior Coatings in an Environmental Chamber
- ASTM E84 Standard Test Method for Surface Burning Characteristics of Building Materials
- ASTM E96 Test Methods for Water Vapor Transmission of Materials
- ASTM E330 Test Method for Structural Performance of Exterior Windows, Doors and Curtain Walls by Uniform Static Air Pressure Difference
- ASTM E331 Test Method for Water Penetration of Exterior Windows, Skylights, Doors and Curtain Walls by Uniform Static Air Pressure Difference.
- ASTM E2098 Test Method for Determining Tensile Breaking Strength of Glass Fiber Reinforcing Mesh for Use in Class PB Exterior Insulation and Finish System after exposure to Sodium-Hydroxide Solution
- ASTM E2134 Test Method for Evaluating the Tensile-Adhesion Performance of an Exterior Insulation and Finish System (EIFS)
- ASTM E2178 Test Method for Air Permeance of Building Materials
- ASTM E2357 Standard Test Method for Determining Air Leakage of Air Barrier Assemblies
- ASTM E2485 (formerly EIMA Std. 101.01) Standard Test Method for Freeze-Thaw Resistance of Exterior Insulation and Finish Systems (EIFS) and Water-Resistive Barrier Coatings
- ASTM E2486 (formerly EIMA Std. 101.86) Standard Test Method for Impact Resistance of Class PB and PI Exterior Insulation and Finish Systems (EIFS)
- ASTM E2568 Standard Specification for Class PB Exterior Insulation and Finish Systems
- ASTM G23 Standard Practice for Operating Light-Exposure Apparatus (Carbon-Arc Type) with and without Water for Exposure of Nonmetallic Materials
- ASTM G53 Practice for Operating Light- and Water-Exposure Apparatus (Fluorescent UV-Condensation Type) for Exposure of Nonmetallic Materials
- B. Building Code Standards
  - Acceptance Criteria for EIFS Clad Wall Assemblies
- C. National Fire Protection Association (NFPA) Standards
  - NFPA 268 Standard Test Method for Determining Ignitibility of Exterior Wall Assemblies Using a Radiant Heat Energy Source
  - NFPA 285 Standard Method of Test for the Evaluation of Flammability Characteristics of Exterior Non-Load Bearing Wall Assemblies containing Combustible Components Using the Intermediate-Scale, Multistory Test Apparatus
- D. Other Referenced Documents
  - American Association of Textile Chemists and Colorists AATCC-127 Water Resistance: Hydrostatic Pressure Test
  - APA Engineered Wood Association E30, Engineered Wood Construction Guide
  - UES Evaluation Report 433, Master Wall EIF Systems



# Aggre-flex EIFS – Continuously Insulated

## Section 07 24 13

### 1.04 SYSTEM DESCRIPTION

A. General: The Master Wall Inc.® Aggre-flex System is a continuously insulated (CI) Exterior Insulation and Finish System, Class PB (polymer-based), consisting of adhesive or mechanical fasteners, expanded polystyrene insulation board, base coat, reinforcing mesh(es) and finish. The System shall be attached over an approved substrate and air/water barrier in accordance with the Aggre-flex application Details.

#### B. Methods of Installation

1. Field Applied: The Aggre-flex System is applied to the substrate system in place.
2. Panelized: The Aggre-flex System is shop-applied to the prefabricated wall panels.

#### C. Design Requirements

1. Acceptable substrates for the Aggre-flex System shall be:
  - a. Exterior sheathing having a water-resistant core with fiberglass mat facers meeting ASTM C 1177.
  - b. Exterior fiber reinforced cement or calcium silicate boards.
  - c. APA Exterior or Exposure 1 Rated Plywood, Grade C-D or better, nominal 12.7 mm (1/2 in), minimum 4-ply.
  - d. Unglazed, unpainted brick, cement plaster, concrete, or masonry.
  - e. APA Exposure 1 rated Oriented Strand Board (OSB) or plywood, nominal 12.7 mm (1/2 in).
  - f. Other substrates approved in writing from the manufacturer.
2. Deflection of substrate systems shall not exceed 1/240 times the span.
3. The substrate shall be flat within 6.4 mm (1/4 in) in a 3.05 m (10 ft) radius.
4. The slope of inclined surfaces shall not be less than 6:12, and the length shall not exceed 305 mm (12 in).
5. All areas requiring an impact resistance classification higher than “medium”, as defined by ASTM E 2486 (formerly EIMA Std. 101.86), shall be as detailed in the drawings and described in the contract documents.
6. Expansion Joints
  - a. Design and location of expansion joints in the Aggre-flex System is the responsibility of the project designer and shall be noted on the project drawings. As a minimum, expansion joints shall be placed at the following locations:
    - 1) Where expansion joints occur in the substrate system.
    - 2) Where building expansion joints occur.
    - 3) At floor lines in wood frame construction (Reference Technical Bulletin #140).
    - 4) At floor lines of non-wood framed buildings where significant movement is expected.
    - 5) Where the Aggre-flex System abuts dissimilar materials.
    - 6) Where the substrate type changes
    - 7) Where prefabricated panels abut one another
    - 8) Where significant structural movement occurs such as changes in roofline, building shape or structural system.
7. Terminations
  - a. Interior foam expanding foam sealant may be required behind penetration openings.
  - b. The Aggre-flex System shall be held back from adjoining materials around openings and penetrations such as windows, doors and mechanical equipment a minimum of 12.7 mm (1/2 in) for sealant application. Sealant joints shall be properly sized and designed for their anticipated movement (Reference Master Wall Inc.® Technical Bulletins #148 & 149).
  - c. The system shall be terminated a minimum of 152 mm (6 in) above finished grade.
  - d. Sealants
    - 1) Shall be manufactured and supplied by others.
    - 2) Shall be compatible with Aggre-flex System materials. Refer to current Master Wall Inc.® Technical Bulletin #131 for listing of sealants approved by sealant manufacturer for use with EIFS.
    - 3) The sealant backer rod shall be of closed cell.
8. Vapor Retarders and barriers – The use and location of vapor retarders and/or barriers within a wall assembly is the responsibility of the project designer and shall comply with local building code requirements.



## Aggre-flex EIFS – Continuously Insulated Section 07 24 13

9. Dark Colors - The use of dark colors must be considered in relation to wall surface temperature as a function of local climatic conditions. Use of dark colors in high temperature climates can affect the performance of the system.
10. Flashing: Shall be provided at all roof-wall intersections, windows, doors, chimneys, decks, balconies and other areas as necessary to prevent water from entering behind the Aggre-flex System and wall system.

### 1.05 PERFORMANCE REQUIREMENTS

A. Aggre-flex System shall have been tested as follows:

#### EIFS Weather Resistance and Durability Performance\*

TEST	METHOD	CRITERIA	RESULTS
1. Accelerated Weathering	ASTM G153 (Formerly ASTM G23)	No deleterious effects at 2000 hours when viewed under 5x magnification	Pass
2. Accelerated Weathering	ASTM G154 (Formerly ASTM G53)	No deleterious effects at 2000 hours	Pass
3. Freeze/Thaw Resistance	ASTM E2485	No deleterious effects at 10 cycles when viewed under 5x magnification	Pass
4. Water Penetration	ASTM E331 (modified per ICC-ES AC 235)	No water penetration beyond the plane of the base coat/insulation board interface after 15 minutes at 6.24 psf (299 Pa) or 20% of design wind pressure, whichever is greater	Pass at 2.86 psf (137 Pa), 6.24 psf (299 Pa), and 12.0 psf (575 Pa) consecutively
5. Water Resistance	ASTM D2247	No deleterious effects at 14 day exposure	Pass @ 28 days
6. Salt Spray	ASTM B117	No deleterious effects* at 300 hours	Pass @ 300 hrs
7. Abrasion Resistance	ASTM D968	No cracking or loss of film integrity at 528 quarts (500 L) of sand	Pass
8. Mildew Resistance	ASTM D3273	No growth supported during 28 day exposure period	Pass
9. Impact Resistance	ASTM E2486	Level 1: 25-49 in-lbs (2.83-5.54J) Level 2: 50-89 in-lbs (5.65-10.1J) Level 3: 90-150 in-lbs (10.2-17J) Level 4: >150 in-lbs (>17J)	Pass with one layer Standard Mesh Pass with one layer Standard Mesh Pass with Medium & Standard Mesh Pass with Strong & Standard Mesh
10. Transverse Wind Load	ASTM E330	Withstand positive and negative wind loads as specified by the building code.	Pass. Assemblies vary from 68-287 psf*

\* Ultimate wind loads – contact Master Wall for specific assemblies.



## Aggre-flex EIFS – Continuously Insulated Section 07 24 13

### EIFS Fire Performance

TEST	METHOD	CRITERIA	RESULT
1. Fire Endurance	ASTM E119	Maintain fire resistance of existing rated assembly	See Technical Bulletin MW#168-030111 for assemblies
2. Radiant Heat Ignition	NFPA 268	No ignition @ 20 minutes	Pass
3. Surface Burning (individual components)	ASTM E84	Individual components shall each have a flame spread of 25 or less, and smoke developed of 450 or less	Flame Spread: 0 Smoke Developed: 0

### EIFS Component Performance

TEST	METHOD	CRITERIA	RESULT
1. Alkali Resistance of Reinforcing Mesh	ASTM E2098 (formerly EIMA 105.01)	Greater than 120 pli (21 dN/cm) retained tensile strength	Pass
2. Requirements for Rigid PVC Accessories	ASTM D1784	Meets cell classification 13244C	Pass
EPS (Physical Properties)	ASTM C303, D1622		Pass
Thermal Resistance	ASTM C272	4.0 @ 4.4 °C (40 °F) 3.6 @ 23.9 °C (75 °F)	Pass
Flame Spread Smoke Developed	ASTM E84	25 max. 450 max.	Pass

### 1.06 QUALITY ASSURANCE

#### A. Qualifications

1. System Manufacturer: Shall be Master Wall Inc.®. All materials shall be manufactured or sold by Master Wall Inc.® and shall be purchased from Master Wall Inc.® or its authorized distributors.
2. Contractor: Shall be knowledgeable in the proper installation of the Master Wall Inc.® Aggre-flex System and shall be experienced and competent in the installation of Exterior Insulation and Finish Systems. Additionally, the contractor shall possess a current Master Wall Inc.® applicator certificate issued by Master Wall Inc.®
3. Insulation Board Manufacturer: Shall be approved by Master Wall Inc.®, shall be capable of producing the Expanded Polystyrene (EPS) in accordance with current Master Wall Inc.® specification and code requirements and have a third party quality assurance program in place.

#### B. Regulatory Requirements

1. The EPS shall be separated from the interior of the building by a minimum 15-minute thermal barrier.
2. The use and maximum thickness of EPS shall be in accordance with the applicable building codes.

#### C. Certification

1. The Aggre-flex System shall be recognized for the intended use by the applicable building code(s).

#### D. Mock-Up

1. The contractor shall, before the project commences, provide the owner/architect with a mock-up for approval.



## Aggre-flex EIFS – Continuously Insulated Section 07 24 13

2. The mock-up shall be of suitable size as required to accurately represent the products being installed, as well as each color and texture to be utilized on the project.
3. The mock-up shall be prepared with the same products, tools, equipment and techniques required for the actual application. The finish used shall be from the same batch that is being used on the project.
4. The approved mock-up shall be available and maintained at the job site.
5. For panelized construction, the mock-up shall be available and maintained at the panel fabrication location.

### 1.07 DELIVERY, STORAGE AND HANDLING

- A. All Master Wall Inc.® materials shall be delivered to the job site in the original, unopened packages with labels intact.
- B. Upon arrival, materials shall be inspected for physical damage, freezing, or overheating. Questionable materials shall not be used.
- C. Deliver all materials in original unopened packages with labels intact. Verify all quantities, colors, and textures against bill of lading.
- D. Store all materials protected from direct exposure to weather conditions and at temperatures not less than 40°F (4°C) or greater than 110°F (43°C).
- E. Stack insulation board flat, fully supported off the ground and protected from direct exposure to the sun.
- F. Material Safety Data Sheets (MSDS) or Safety Data Sheets (SDS) shall be supplied for the components of the EIFS and be available at the job site.

### 1.08 PROJECT CONDITIONS

- A. Ambient air temperatures shall be 40°F (4°C) or greater and rising at the time of installation of the Master Wall Inc.® products and shall remain at 40°F (4°C) or greater for at least 24 hours after application.
- B. Provide supplemental heat and protection as required when the temperature and conditions are not in accordance with installation requirements. Sufficient ventilation and time shall be provided to ensure that materials have sufficiently dried prior to removing supplemental heat.
- C. Adequate protection shall be provided to prevent weather conditions (humidity, temperature, and precipitation) from having an affect on the curing or drying time of Master Wall Inc.® materials.
- D. Adjacent materials and the Aggre-flex System shall be protected during installation and while curing from weather and shall be protected from site damage.
- E. Coordinate installation of the Aggre-flex System with related work specified in other sections to ensure that the wall assembly is protected to prevent water from getting behind the system. The cap flashing shall be installed as soon as possible after the finish coat has been applied. When this is not possible, temporary protection shall be provided immediately in this area.
- F. All sealant work shall be installed in a timely manner. Protect open joints from water intrusion during construction with backer rod, or temporary covering, until permanently sealed.
- G. Sufficient manpower and equipment shall be employed to ensure a continuous operation, free of cold joints, scaffolding lines, and texture variations, etc.
- H. Existing Conditions - The contractor shall have access to electric power, clean water, and a clean work area at the location where the Master Wall Inc.® materials are to be applied.

### 1.09 SEQUENCING AND SCHEDULING

- A. Installation of the Aggre-flex System shall be coordinated with other construction trades.
- B. Sufficient manpower and equipment shall be employed to ensure a continuous operation, free of cold joints, scaffold lines, texture variations, etc.

### 1.10 LIMITED MATERIALS WARRANTY

- A. Provide a manufacturer's warranty against defective material upon request.

### 1.11 MAINTENANCE

- A. Maintenance and repair shall follow the procedures noted in Master Wall Inc.® Technical Bulletins #112 and #129.



# Aggre-flex EIFS – Continuously Insulated

## Section 07 24 13

### **PART II – PRODUCTS**

#### **2.01 MANUFACTURER**

- A. All components of the Aggre-flex System shall be supplied or obtained from Master Wall Inc.® or its authorized distributors. Substitutions or additions of materials other than specified will void the warranty.

#### **2.02 MATERIALS**

- A. Portland Cement: Shall be Type I or II, meeting ASTM C 150, white or gray in color, fresh and free of lumps.  
B. Water: Shall be potable, clean and free of foreign matter.  
C. Metal Flashing Components: Complying with SMACNA Recommendations. Reference Section 07620.  
D. Sealant Systems: Reference Sealant Specification, Section 07900.  
E. Window & Door Systems: Detailed by the designer and suitable for EIFS. Reference Section 08000.

#### **2.03 COMPONENTS**

(Typical Application/Optional Component)

##### **A. Starter Tracks/Casing**

1. Vinyl Corp. foundation sill screed product #WS50-250U, Plastic Components Product # 632-50, Amico Foundation Weep Screed AMFWS425-500, Amico Foundation Weep Screed (NO. 7) or approved equal.
2. Vinyl Corp. PB Starter Strip/Casing Bead product # CBS 150-16W or Plastic Components Starter Track product # STWP-15 shall be used in accordance with Master Wall Inc.® details.
3. Alternate termination methods may be used in accordance with Master Wall Inc.® details and recommendations.

##### **B. Mechanical Fasteners and Plastic Washers**

1. The Wind-Devil 2 plate or approved equal shall be used with the appropriate corrosion-resistant fastener shall be used to meet the requirements of the specific project, local building code and the anticipated wind loads.

##### **C. Adhesives**

1. Master Wall Inc. Foam & Mesh (F&M) Adhesive: An acrylic-based product mixed one-to-one by weight with Portland cement designed for use with reinforcing mesh as the base coating over the insulation board.
2. Master Wall Bagged Base Coat (MBB): A polymer based cementitious product mixed with 5 to 6 quarts of water for use as an adhesive and base coating over the insulation board.
3. **F&M Plus: An acrylic-based high build product mixed one-to-one by weight with Portland cement designed for use with reinforcing mesh as the base coating over the insulation board. (This product shall be used where indicated on the construction drawings when a leveling base coat is required.)**
4. Expanded PolyStyrene Adhesive (EPSA): a water-based acrylic copolymer adhesive formulated to bond MEPS insulation board to plywood and other approved substrates.

##### **D. Insulation Board**

1. Insulation Board shall meet or exceed ASTM C-578.
2. Nominal 1.0 pcf, aged expanded polystyrene.
3. Flamespread and smoke development shall be 25 and 450 or less respectively per ASTM E-84.
4. Maximum size 2'x4'x4" (.61 m x 1.22 m x 102 mm). Refer to actual contract documents to determine actual insulation board thickness.

##### **E. Reinforcing Mesh**

Open weave glass fiber fabric, treated for alkaline resistance and compatibility with Master Wall Base Coats, and conforming ASTM D-76, D-579, D-5035, MIL-Y-1140 and meeting a minimum Medium Impact Resistance (50-89 in-lbs) when tested to EIMA 101.86 Impact Resistance Standards.

1. Detail Mesh
2. Standard Mesh
3. **Hi-Tech Mesh**
4. **Medium Mesh**
5. **Strong Mesh**
6. **Ultra Mesh**



## Aggre-flex EIFS – Continuously Insulated Section 07 24 13

### F. Base Coats

1. Master Wall Inc.® Foam & Mesh (F&M) Adhesive: An acrylic-based product mixed one-to-one by weight with Portland cement for use with reinforcing mesh as the base coating over the insulation board.
2. Master Wall Bagged Base Coat (MBB): A polymer based cementitious product mixed with 5 to 6 quarts of water for use with reinforcing mesh as the base coating over the insulation board.
3. F&M Plus: An acrylic-based high build product mixed one-to-one by weight with Portland cement designed for use with reinforcing mesh as the base coating over the insulation board. (This product shall be used where indicated on the construction drawings when a leveling base coat is required.)
4. Expanded Polystyrene Base (EPSB): a 100% pure acrylic polymer based noncementitious base coat.

### G. Water Resistant Adhesive & Base Coat

1. Guardian – An acrylic-based product mixed one-to-one by weight with Portland cement for use as the adhesive to bond insulation board to an approved substrate and/or as a base coat with reinforcing mesh over insulation board. (This product should be used as designated on the construction drawings where additional resistance to moisture is needed.)

### H. Primer – Especially useful under dark colors

1. Primecoat Primer - Acrylic-based tintable primer
2. Sanded Primecoat Primer - Acrylic-based tintable primer with sand

### I. Superior Finishes: Master Wall Inc.® Superior Finishes are acrylic-based wall coatings available in a variety of colors and textures. The following textures are available:

1. Perfect2.0 (Perfect) - riled texture
2. Fine Sand 1.0 (Spray) – sand type texture
3. Medium Sand 1.5 (Desert Sand) – coarse sand texture
5. Versatex 0.5 (Refinish) – Fine texture used to create numerous finishes

### J. Finish Enhancements

1. Silicone Coat - Factory added silicone enhancement for better water resistance and to keep buildings cleaner.
2. Excel Mildew Enhancement - Factory added mildew booster exceeding ASTM D3273 requirements.
3. Elastomeric Plus - Increases flexibility and bridges minor hairline cracks.

### K. Specialty Finishes

1. Superior Stone
2. Aggrestone
3. Lumia
4. Plaster Flex
5. Metallic Cote
6. Savannah
7. Marbleflex
8. Travertine
9. Eco Glass
- 10 Aggrelime
11. Brick Finish System

### L. Accents & Coatings

1. Roller-flex architectural coating
2. Elasto-flex elastomeric architectural coating
3. Clearshield clear protective coating
4. Vintique antiquing accent



# Aggre-flex EIFS – Continuously Insulated

## Section 07 24 13

### **PART III – EXECUTION**

#### **3.01 EXAMINATION**

- A. Prior to installation of the Aggre-flex System, the contractor shall verify that the substrate:
  - 1. Is of a type listed in Section 1.04.C.1.
  - 2. Is flat within 6.4 mm (1/4 in) in a 3 m (10 ft) radius.
  - 3. Is sound, dry, connections are tight, has no surface voids, projections or other conditions that may interfere with the Aggre-flex System installation or performance.
- B. Prior to the installation of the Aggre-flex System, the architect or general contractor shall insure that all needed flashings and other waterproofing details have been completed, if such completion is required prior to the Aggre-flex application. Additionally, the Contractor shall ensure that:
  - 1. Metal roof flashing has been installed in accordance with Asphalt Roofing Manufacturers Association (ARMA) Standards.
  - 2. Openings are flashed in accordance with the Aggre-flex System Installation Details or as otherwise necessary to prevent water penetration.
  - 3. Chimneys, Balconies, and Decks have been properly flashed.
  - 4. Windows, Doors, etc. are installed and flashed per manufacturer's requirements and the Aggre-flex System Installation Details.
- C. Prior to the installation of the Aggre-flex System, the contractor shall notify the general contractor, and/or architect, and/or owner of all discrepancies.

#### **3.02 PREPARATION**

- A. Aggre-flex materials shall be protected by permanent or temporary means from inclement weather and other sources of damage prior to, during, and following application until completely dry.
- B. Protect adjoining work and property during Aggre-flex installation.
- C. The substrate shall be prepared as to be free of foreign materials, such as, oil, dust, dirt, form release agents, efflorescence, paint, wax, water repellents, moisture, frost and any other condition that inhibit adhesion.

#### **3.03 GENERAL GUIDELINES**

- A. The system shall be installed in accordance with the current Master Wall Inc.® Aggre-flex System Application Instructions.
- B. The overall minimum base coat thickness shall be sufficient to fully embed the mesh.
- C. Sealant shall not be applied directly to textured finishes.
- D. When installing the Aggre-flex System, adhere according to Master Wall Inc.® and local requirements.

#### **3.04 AGGRE-FLEX EIFS INSTALLATION**

- A. Design Considerations
  - 1. The minimum slope of inclined surfaces shall not be less than 6" (152 mm) in 12" with a maximum length of 12" unless approved in writing by Master Wall Inc.®. Inclined surfaces which are or could be defined as roofs by the building codes or application are not approved by Master Wall Inc.®
  - 2. The use of dark colors must be considered in relation to wall surface temperature as a function of local climatic conditions.
  - 3. The Insulation Board shall be separated from the interior of the building by a 15-minute thermal barrier.
  - 4. The use and maximum thickness of insulation board shall be in accordance with the applicable building codes, typically 3/4" (19 mm) minimum and 4" (102 mm) maximum.
  - 5. The EIF System shall be recognized by a current code report.
  - 6. It is the responsibility of the architect and the purchaser to determine if a product is suitable for their intended use. The architect or designer of the project shall be responsible for all decisions pertaining to the design, details, structural capability, attachment details, shop drawings and the like. Master Wall Inc.® has prepared specifications, details and data sheets to assist as guidelines for the use and installation of the products. Master Wall Inc.® is not responsible for the design, details, structural capability, attachment details and shop drawings whether it is based on Master Wall Inc.® information or not.



## Aggre-flex EIFS – Continuously Insulated Section 07 24 13

7. Expansion joints in the system are required at building expansion joints, at prefabricated panel joints, where substrates change, at floor lines in wood framed construction, and where structural movement is anticipated. Reference construction documents for exact locations.
  8. Aesthetic Joints may be installed to provide sufficient break points in the EIF System to prevent cold joints from occurring in the finish coat. Aesthetic joints shall not be used in lieu of an expansion joint
- B. Mixing
1. Mix the products following the instructions on the product data sheets.
  2. Additives shall not be added to Master Wall Inc.® materials unless written approval has been received from Master Wall Inc.®
- C. Preparation
1. Protect contiguous work from damage during application of the Aggre-flex EIF System. Temporary covering may be required to prevent over spray or splattering of exterior finish coatings on other work.
  2. Protect substrate from inclement weather during installation. Prevent infiltration of moisture behind the system that may affect the substrate or the attachment of the insulation board to the substrate.
  3. Adhesive, Base Coats and Finishes shall not be installed when ambient air temperature is below 40°F (4°C). The temperature shall remain at or above 40°F (4°C) during mixing, application and until materials have cured.
  4. Sufficient scaffolding, manpower and tools shall be provided to prevent cold joints.
  5. Flashings shall be installed as required by construction documents and Master Wall Inc.® details in a manner to prevent the intrusion of water behind the insulation board and wall system. All flashing materials should direct the water to the exterior face of the finished system.
- D. Installation, General
1. Reference architectural details for full wall system requirements.
  2. Comply with the manufacturers' current published instructions, (specifications, details, data sheets and technical bulletins) for the installation of the Aggre-flex EIF System.
  3. Comply with local building codes.
  4. Verify that all flashings and other items are in place.
- E. Starter Track or Casing Option
1. Install the starter track, casing or alternate termination method where the system ends at the foundation. Install track at least 6" (152 mm) above grade, at least ¾" (19 mm) above structurally supported paving/patios, or at least 2" (51 mm) above unsupported patios
  2. Backwrap details are used in accordance with Master Wall Inc.® details.
  3. Alternatively, casing beads can be installed at other areas such as around window and door openings.
- F. Backwrapping
1. Adhesively or mechanically secure reinforcing detail or standard mesh to the substrate positioned so that a minimum of 2 ½" (63.5 mm) of the mesh is onto the substrate. (The reinforcing mesh shall be wide enough to encapsulate the edge of the insulation board and cover both the substrate and the face of the insulation board a minimum of 2 ½".)
  2. After the insulation board is applied, complete the backwrapping procedure by applying the base coat, embedding the remaining mesh and returning it onto the face of the insulation board.
  3. Where sealants are applied the reinforcing mesh color shall not be visible and the texture of the base coat shall be smooth so that the pattern of the mesh is covered.
  4. Apply finish in accordance with manufacturer's details. (Finish shall not be applied to areas where the design professional has anticipated dynamic movement or at an EIFS to EIFS joint.).



## Aggre-flex EIFS – Continuously Insulated Section 07 24 13

### 3.05 FIELD QUALITY CONTROL

- A. The contractor shall be responsible for the proper application of the Aggre-flex materials.
- B. Master Wall Inc.® assumes no responsibility for on-site inspections or application of its products.
- C. If required, the contractor shall certify in writing the quality of work performed relative to the substrate system, details, installation procedures, workmanship and as to the specific products used.
- D. If required, the EPS supplier shall certify in writing that the EPS meets Master Wall Inc.® specifications.
- E. If required, the sealant contractor shall certify in writing that the sealant application is in accordance with the sealant manufacturer's and Master Wall Inc.® recommendations.
- F. Master Wall Inc.'s current published details, specifications, data sheets, technical bulletins and other literature/information are minimum standards and guidelines that shall be followed when designing and detailing a project with the Aggre-flex EIF System.
- G. Details shall conform to Master Wall Inc.'s details and shall be consistent with the project requirements.
- H. Master Wall Inc. must approve deviations from the standard published details in writing.
- I. The architect, engineer or the designer of the project should determine where the dew point would occur in relationship to the wall assembly and the project location during summer and winter conditions.
- J. Drip details shall be specified in accordance with Master Wall Inc.'s published details.
- K. At all locations the reinforced base coat, trim accessories or the substrate shall encapsulate the approved insulation board.

### 3.06 INSULATION APPLICATION

- A. Insulation Application - Adhered
  - 1. Notched Trowel Method - Foam & Mesh (F&M) Adhesive, Master Wall Bagged Base Coat (MBB), F&M Plus shall be applied to the entire surface of one face of the approved insulation board.
  - 2. Apply the adhesive mixture directly to the back of the insulation board using approved stainless steel notched trowel. With the trowel at a 45 degree angle, cover the entire back of the insulation board with full beads of adhesive. Apply the adhesive so the ribbons run vertically when applied to the wall.
  - 3. Do not adhere the edges of the insulation board to each other.
  - 4. Apply the approved insulation board over a dry substrate with the long edge oriented horizontally.
  - 5. The application of the insulation board shall commence at the base of the wall from a level line of support.
  - 6. After the adhesive has been applied to insulation board it shall be installed by sliding it into place until it abuts adjoining insulation board.
  - 7. Uniform pressure shall be applied over the entire surface of the insulation board to achieve contact with the substrate. Periodically check the contact of the adhesive to the substrate by removing a piece of insulation board. Proper adhesive contact should be demonstrated by the evidence of similar amounts of adhesive adhered to both the insulation board and the substrate. The cohesive break should occur when the board is removed. If the cohesive break had occurred prior to the adhesive set the substrate is more than likely out of plane and should be corrected to meet minimum standards of this specification. If a cohesive failure does not occur contact a Master Wall representative.
  - 8. The insulation board shall be installed in a running bond pattern with staggered vertical joints.
  - 9. Insulation boards shall be interlocked at the inside and outside corners.
  - 10. Insulation board joints shall be offset from the sheathing joints a minimum of 6" (152 mm).
  - 11. Insulation board joints shall be offset from the corners of openings.
  - 12. Allow for proper spacing at windows, doors, penetrations and other openings so that sealant systems can be installed in accordance with Master Wall Inc.® specification, details and the construction documents.
  - 13. Provide a proper joint through insulation board where expansion joints occur in substrates and where required in the system.
  - 14. Wrap mesh in or around details in accordance with Master Wall Inc.® instructions.
  - 15. The insulation board shall be butted tightly. Any gaps greater than 1/16" (1.6 mm) between insulation boards shall be filled with slivers of insulation board. Adhesive shall not be used to adhere foam when filling gaps.
  - 16. Gaps between insulation boards shall not be filled with adhesive or base coat materials.
  - 17. Allow adhered insulation to remain undisturbed for a period of 12 hours prior to rasping the foam.
- B. Insulation Application - Mechanically Attached



## Aggre-flex EIFS – Continuously Insulated Section 07 24 13

1. Fasten the insulation board using Wind-lock Wind-Devil 2 or approved washer and appropriate corrosion-resistant fastener. Master Wall Inc. must approve other mechanical fastening systems in writing prior to use with the Aggre-flex System.
2. Fastening patterns shall be determined by the requirements of the geographical conditions of the area, local code requirements and the performance of the fasteners, washers and their test results in conjunction with the specified substrate and the thickness of foam specified for use.
- C. Apply the approved insulation board over a dry substrate with the long edge oriented horizontally.
- D. The application of the insulation board shall commence at the base of the wall from a level line of support at the casing bead or termination.
- E. The insulation board shall be installed in a running bond pattern with staggered vertical joints.
- F. Insulation boards shall be interlocked at the inside and outside corners.
- G. Insulation board joints shall be offset from the sheathing joints a minimum of 6" (152 mm).
- H. Insulation board joints shall be offset from the corners of openings.
- I. Allow for proper spacing at windows, doors, penetrations and other openings so that sealant systems can be installed in accordance with Master Wall Inc.'s specification, details and the construction documents.
- J. Provide a proper joint through insulation board where expansion joints occur in substrates and where required in the system.
- K. Wrap mesh in or around details in accordance with Master Wall Inc. instructions.
- L. The insulation board shall be butted tightly. Any gaps greater than 1/16" (1.6 mm) between insulation boards shall be filled with slivers of insulation board. Adhesive shall not be used to adhere foam when filling gaps.
- M. Gaps between insulation boards shall not be filled with adhesive or base coat materials.
- N. Rasp the entire surface of the insulation board to level any irregularities. All irregularities greater than 1/16" (1.6 mm) shall be sanded flat.
- O. Cut aesthetic joints as indicated on construction drawings. Always maintain a minimum 3/4" (19 mm) of insulation board under aesthetic joints.
- P. Spot fasteners with base coat and allow to dry.
- Q. Clean rasped insulation board in preparation for base coat application.

### 3.07 BASE COAT APPLICATION

#### A. Base Coat Preparation

1. Inspect adhered insulation board to ensure the installation meets the requirements set forth in Master Wall Inc.® specification, details, data sheets, technical bulletins and the construction documents. Make necessary repairs to ensure the installation meets the requirements prior to commencement of the base coat application.
2. Fill any gaps in the insulation board with slivers of insulation.
3. Rasp the insulation board to provide a true surface within specifications. If the foam is yellowed or has developed a powdery film due to sun exposure the foam must be rasped and cleaned prior to the base coat application.
4. Complete the backwrapping at all system terminations by embedding the reinforcing mesh as described in Section 3.06 of this specification.
5. Install minimum 9 1/2" x 12" (229x309 mm) diagonal reinforcement at all windows, doors, louvers, or other penetration corners. Apply field mesh as soon as possible after diagonal mesh application.
6. Reference architectural documents for locations of designed impact classifications.

#### B. Base Coat Application

1. Apply the base coat to the entire surface of the insulation board to the thickness required for the specified reinforcing mesh to be applied in a given area.
  - a. Standard, Detail and Hi-Tech Mesh require a nominal 1/16" (1.6 mm).
  - b. Medium, Strong and Ultra Mesh requires a nominal 3/32" (2.4 mm).
2. Immediately embed Master Wall Inc.® reinforcing mesh into wet base coat with a trowel, working from the center toward the edges, until the mesh is fully covered and a smooth surface is achieved. The color of the mesh shall not be visible but a slight mesh pattern may be visible.
3. Lap mesh 2 1/2" (64 mm) minimum on all sides. (Do not lap Strong or Ultra mesh.)



## Aggre-flex EIFS – Continuously Insulated Section 07 24 13

4. Reinforcing Mesh shall be continuous through all interior and exterior corners extending beyond the corner a minimum of 12” from both directions creating a minimum of two layers of standard reinforcing mesh on all interior and exterior corners.
5. Standard and Hi-Tech reinforcing mesh can be applied in a single layer.
6. Medium Mesh can be applied in one layer yet it may require an additional coat of base coat mixture to properly embed the mesh after the first coat has dried.
7. Strong and Ultra Mesh require a second layer of base coat reinforced with Standard or Hi-Tech Mesh.
8. EPS shapes shall have reinforcing mesh embedded into the base coat.
9. Allow the base coat to cure a minimum of 12 hours prior to additional base coat or finish coat applications.

### 3.08 FINISH COAT APPLICATION

#### A. Superior Finish Coat Application

1. Surface irregularities in the base coat, such as trowel marks, insulation board lines and reinforcing mesh laps shall be corrected prior to the finish application.
2. Apply the Master Wall Inc.® Superior Finish in the color and texture as approved by the project owner or the project architect with sufficient manpower and equipment to insure a continuous operation without cold joints, scaffolding lines etc. Texture finish shall match approved jobsite samples. Thickness and coverage will vary depending on the specified final appearance.
3. Trowel Application – (Perfect 2.0, Fine Sand 1.0, Medium Sand 1.5, Versatex 0.5)
  - a. Apply the Superior Finish to the clean, dry and cured base coat with a stainless steel trowel.
  - b. Level the surface to a uniform thickness of 3/32” to 1/8” (2.4-3.2 mm).
  - c. Float the Finish with a plastic float in a uniform motion to achieve the desired texture. (Versatex 0.5 cannot be floated easily. A second application of the Versatex 0.5 may be applied to create the desired texture.)
4. Spray Application – (Perfect 2.0, Fine Sand 1.0, Medium Sand 1.5, Versatex 0.5)
  - a. Prime surface with Master Wall Inc.® Primecoat or Sanded Primecoat tinted to match the selected finish color. Allow Primecoat or Roller-Flex to cure a minimum of 12 hours prior to finish coat application.
  - b. Using a conventional plaster hopper gun or a proven pump, spray finish over the primed base coat to achieve desired texture using a circular overlapping pattern keeping the spray gun at a 90° angle to the surface and maintaining the same distance to the wall at all times.
  - c. Be cautious of flooding an area with too much finish because it may appear shinier when it dries.
5. Specialty Finishes: Follow individual product data sheet application instructions.

### 3.09 JOB SITE CLEANUP

- A. Clean work area in accordance with contract documents removing all excess materials, droppings and debris. Clean adjacent surfaces.
- B. Other trades may now install their work – Sheet Metal (Section 07620), Sealants (Section 07900), Mechanical (Section 15000), Electrical (Section 16000).

### 3.10 PROTECTION

- A. Aggre-flex System shall be protected from inclement weather and other sources of damage until dry and permanent protection in the form of flashings, sealants, etc. are installed.

#### Disclaimer

This Specification is published for general informational purposes only and is not intended to imply that these are the only materials, procedures, or methods, which are available or suitable. Materials, procedures, or methods may vary according to the particular circumstances, local building code requirements, design conditions, or statutory and regulatory requirements. While the information in this specification is believed to be accurate and reliable, it is presented without guarantee or responsibility on the part of Master Wall Inc.®



# Aggre-flex™ EIFS

Conceptual Details

Corporate • P.O. Box 397 • Fortson • Georgia • 31808 • 800-755-0825 • FAX 706-569-6704

Technical • 800-760-2861 • FAX 734-433-0930

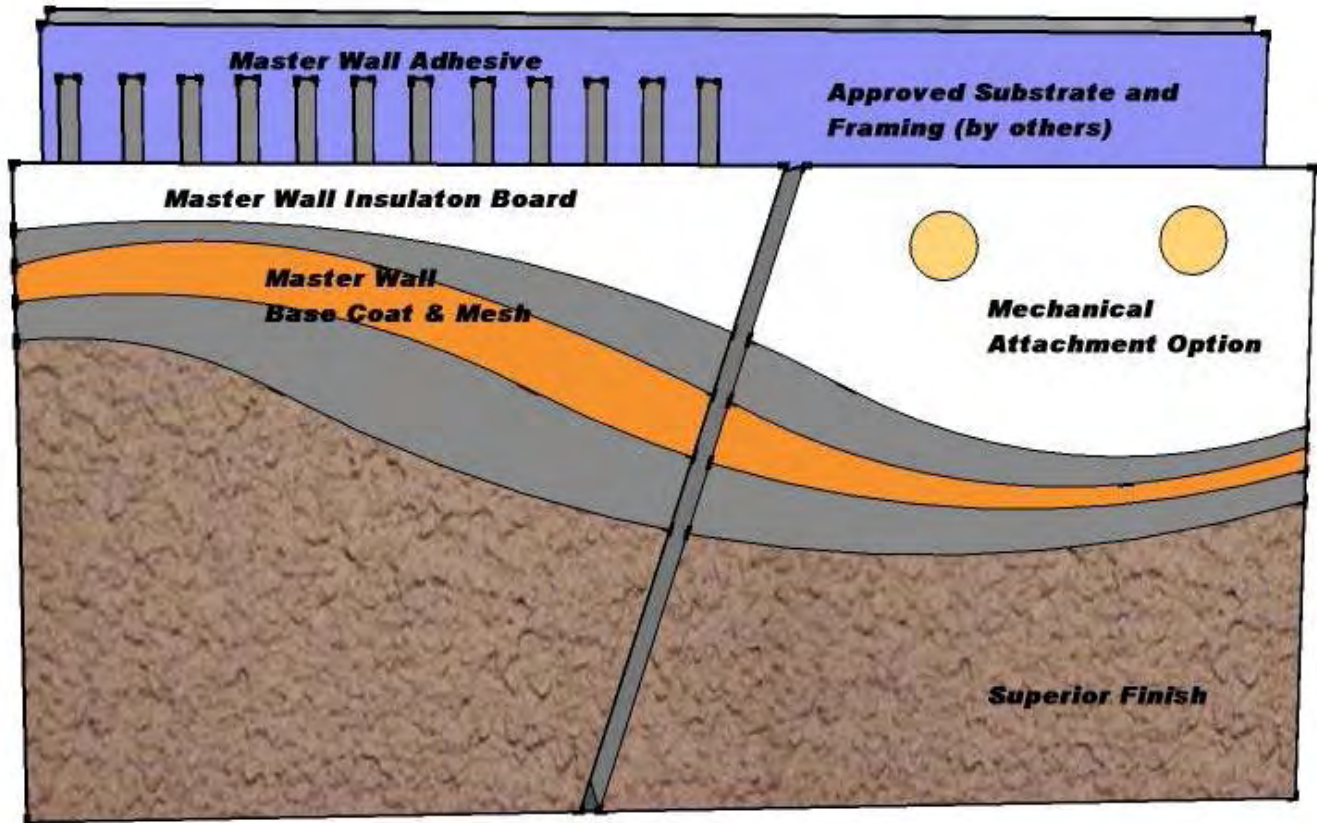

## MWAF-01 CROSS-SECTION

These drawings relay the conceptual conditions of the Aggre-flex EIFS and are not the construction drawings. Ultimately the design and detailing of an entire wall system is the responsibility of a professional. These details will guide the design professional in the use of Master Wall Products. Master Wall disclaims design, warranty or construction intent or responsibility.



## Aggre-flex™ EIFS

Conceptual Details

Corporate • P.O. Box 397 • Fortson • Georgia • 31808 • 800-755-0825 • FAX 706-569-6704

Technical • 800-760-2861 • FAX 734-433-0930

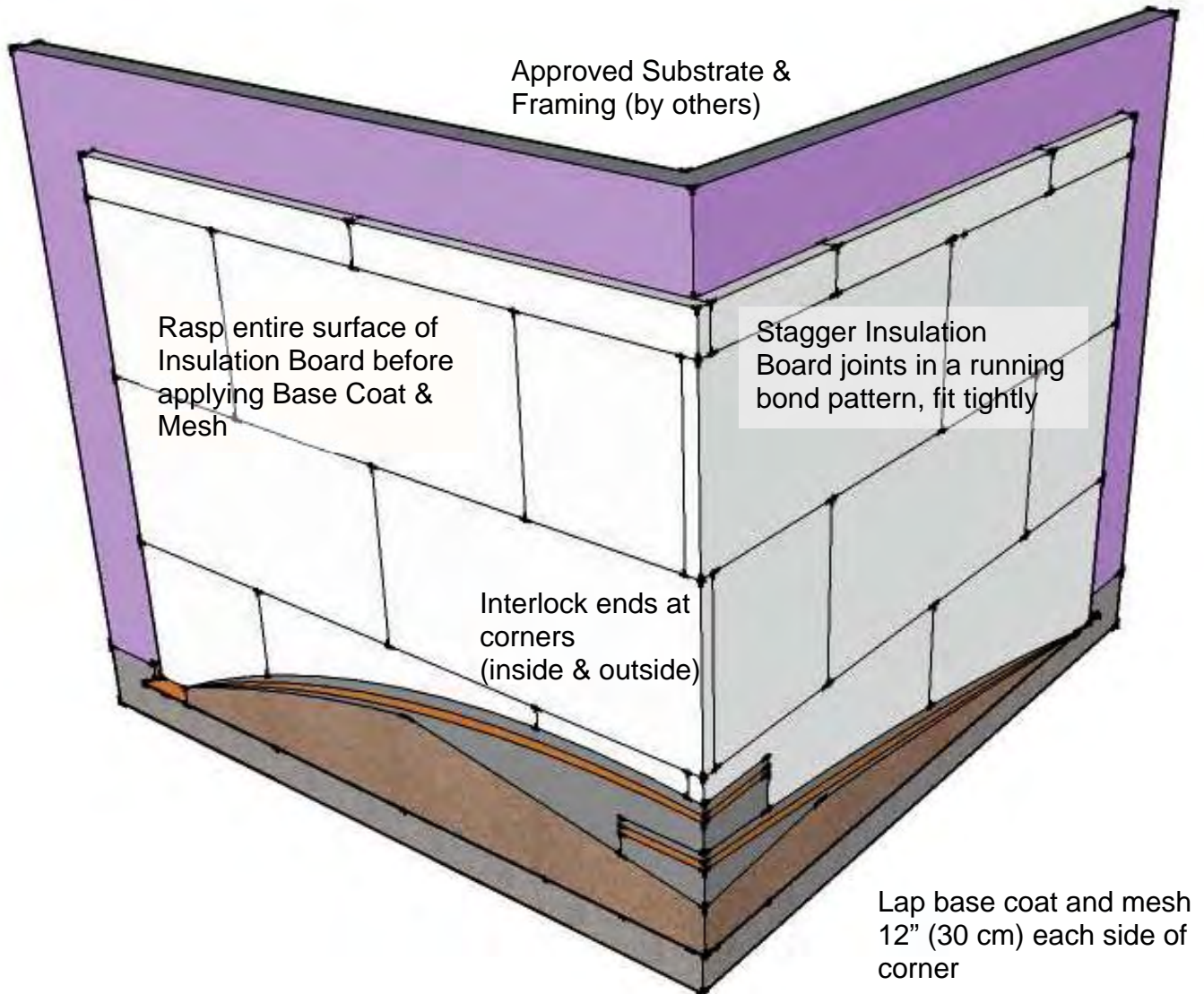

### MWAF-02 INSULATION PATTERN

These drawings relay the conceptual conditions of the Aggre-flex EIFS and are not the construction drawings. Ultimately the design and detailing of an entire wall system is the responsibility of a professional. These details will guide the design professional in the use of Master Wall Products. Master Wall disclaims design, warranty or construction intent or responsibility.



# Aggre-flex™ EIFS

Conceptual Details

Corporate • P.O. Box 397 • Fortson • Georgia • 31808 • 800-755-0825 • FAX 706-569-6704

Technical • 800-760-2861 • FAX 734-433-0930

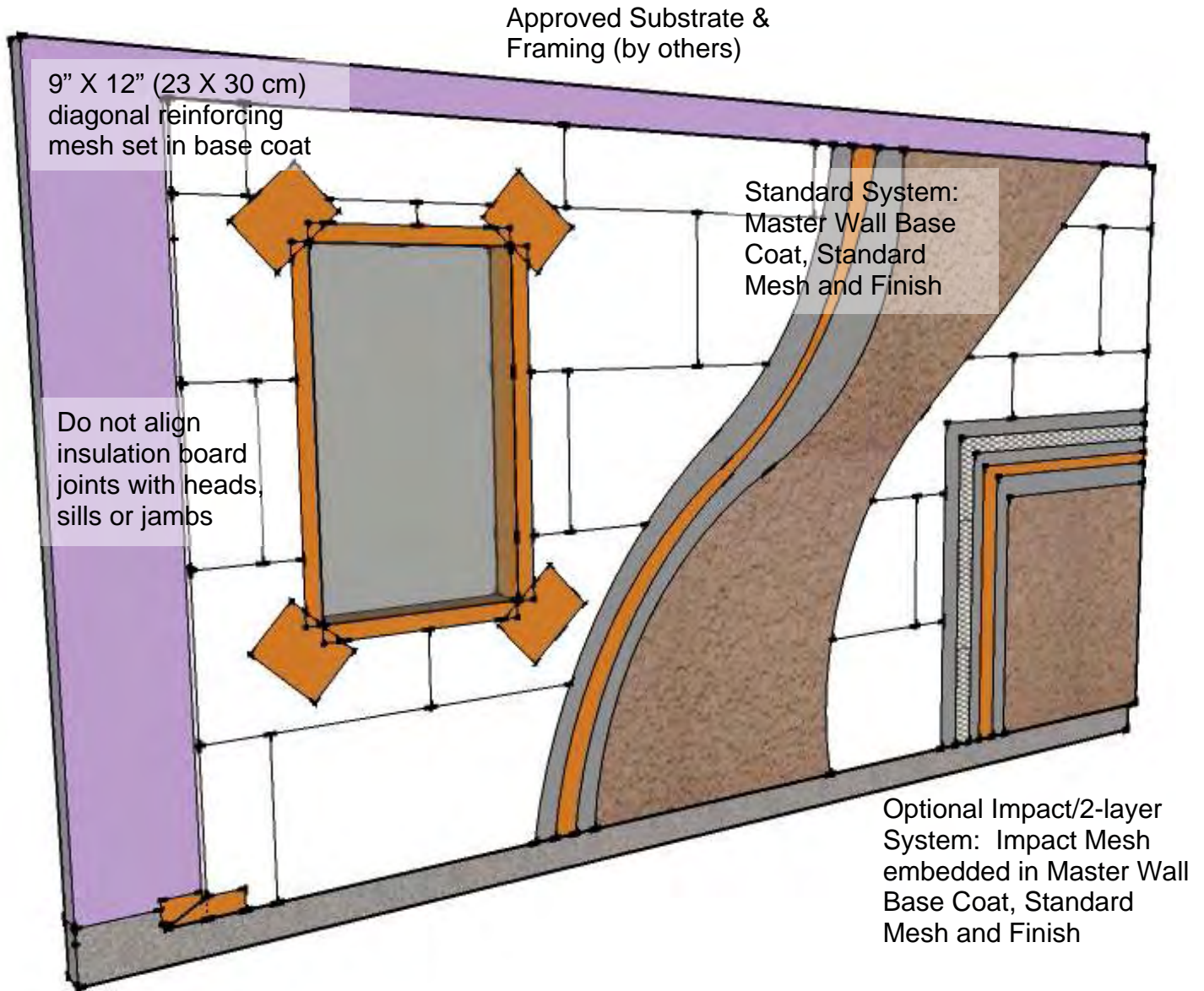

## MWAF-03 MESH APPLICATION

**Note: Lap all mesh 2-1/2" (63 mm) minimum except Strong and Ultra Mesh, which are butted**

These drawings relay the conceptual conditions of the Aggre-flex EIFS and are not the construction drawings. Ultimately the design and detailing of an entire wall system is the responsibility of a professional. These details will guide the design professional in the use of Master Wall Products. Master Wall disclaims design, warranty or construction intent or responsibility.



# Aggre-flex™ EIFS

## Conceptual Details

Corporate • P.O. Box 397 • Fortson • Georgia • 31808 • 800-755-0825 • FAX 706-569-6704

Technical • 800-760-2861 • FAX 734-433-0930

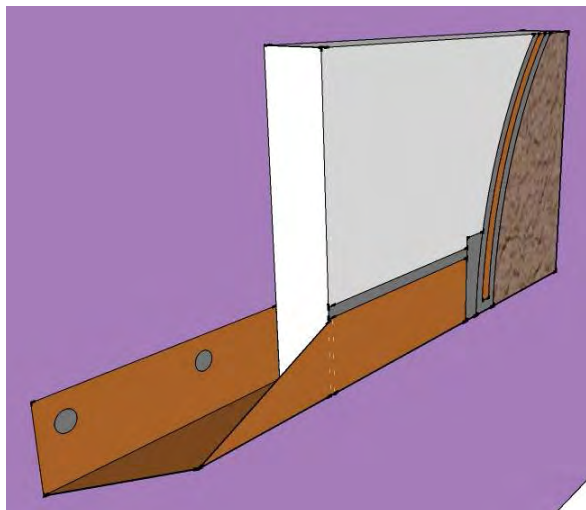
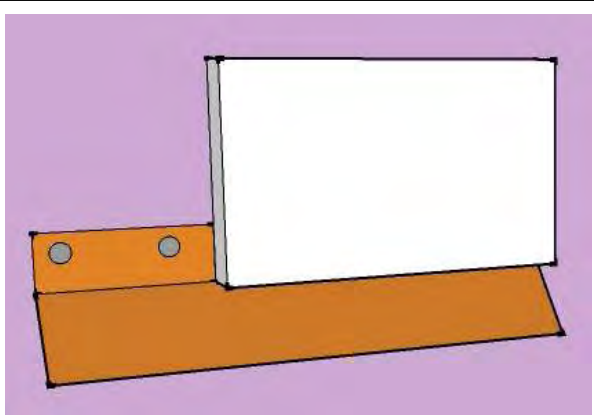

**Backwrap Option:** Tack Detail Mesh 2-1/2" (63 mm) minimum onto substrate using staples, nails or base coat. After insulation board is adhered embed remaining mesh in base coat and turn onto the surface of the insulation board.

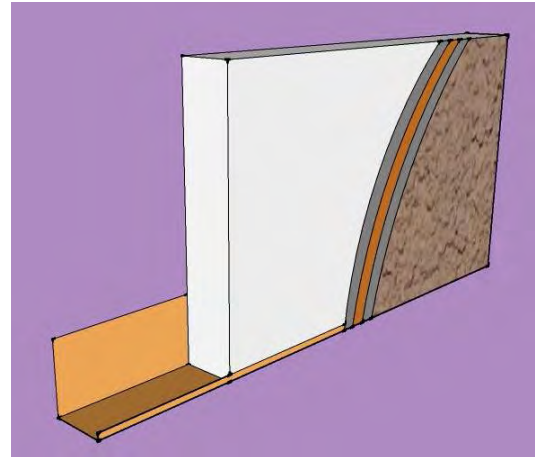

**Casing Option:** Fasten casing bead onto wall surface at 8" centers, slip insulation board into casing bead. Note: casing beads may cause cracking and an irregular planar condition. May not be approved for fire-rated systems.

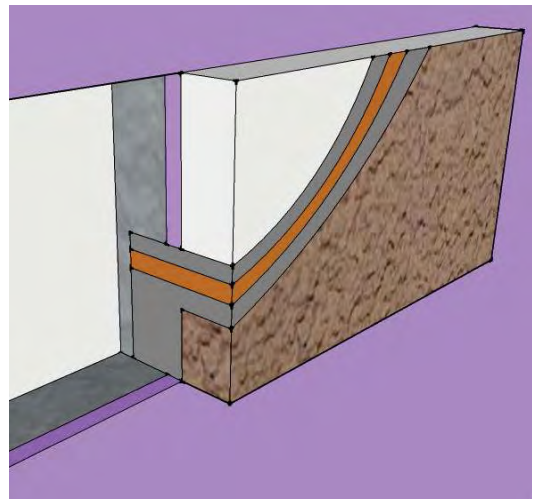

**Wrap Option:** Wrap mesh and base coat 2-1/2" (63 mm) onto the framing or non-moisture sensitive substrate.

## MWAF-04 CLOSURE OPTIONS

These drawings relay the conceptual conditions of the Aggre-flex EIFS and are not the construction drawings. Ultimately the design and detailing of an entire wall system is the responsibility of a professional. These details will guide the design professional in the use of Master Wall Products. Master Wall disclaims design, warranty or construction intent or responsibility.



## Aggre-flex™ EIFS

### Conceptual Details

Corporate • P.O. Box 397 • Fortson • Georgia • 31808 • 800-755-0825 • FAX 706-569-6704

Technical • 800-760-2861 • FAX 734-433-0930

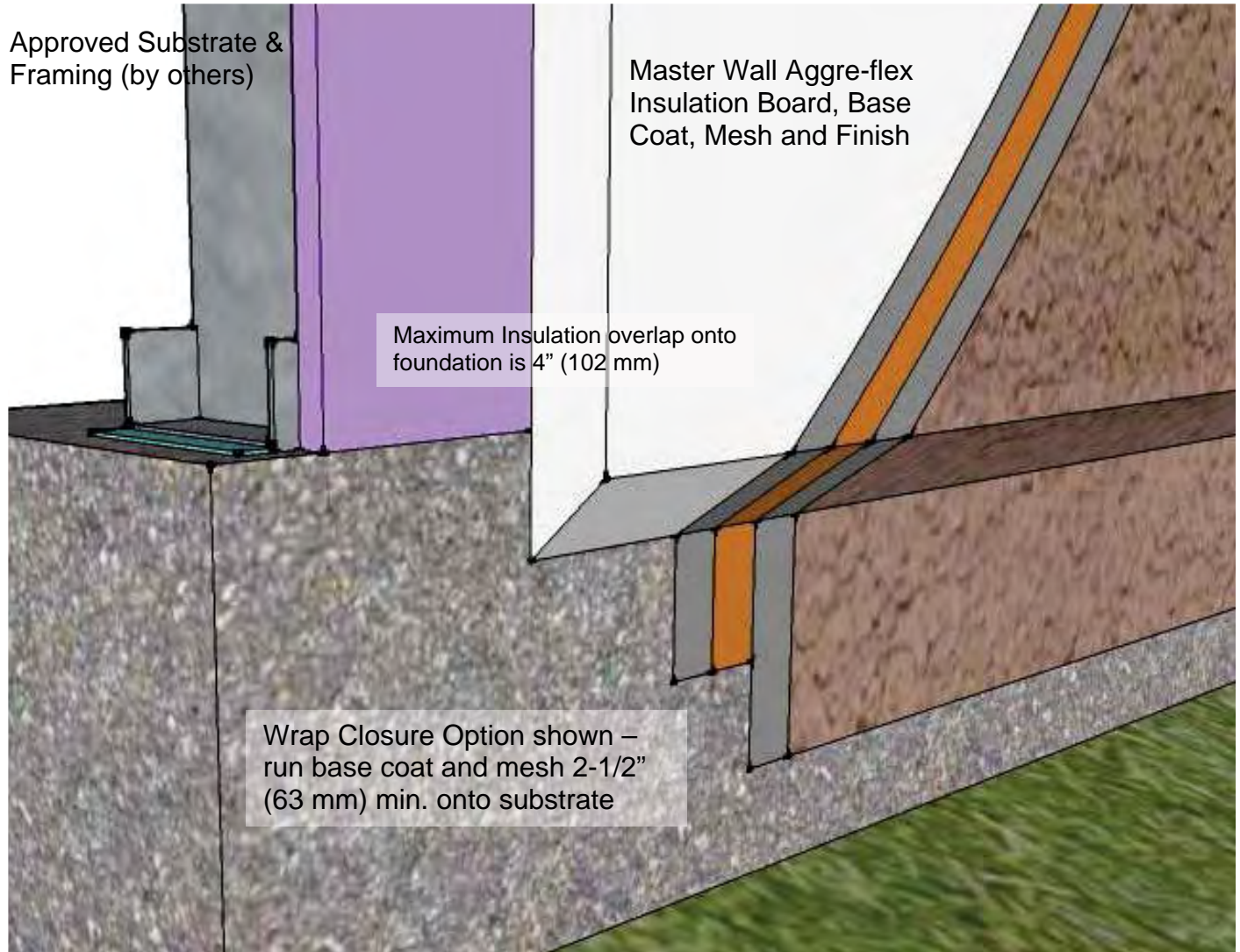

### MWAF-05 FOUNDATION DETAIL

**Note: Keep EIFS a minimum of 6" (152 mm) above grade, slope grade away from building, keep landscaping 3' min. away from building and direct sprinklers away from building.**

These drawings relay the conceptual conditions of the Aggre-flex EIFS and are not the construction drawings. Ultimately the design and detailing of an entire wall system is the responsibility of a professional. These details will guide the design professional in the use of Master Wall Products. Master Wall disclaims design, warranty or construction intent or responsibility.



# Aggre-flex™ EIFS

## Conceptual Details

Corporate • P.O. Box 397 • Fortson • Georgia • 31808 • 800-755-0825 • FAX 706-569-6704

Technical • 800-760-2861 • FAX 734-433-0930

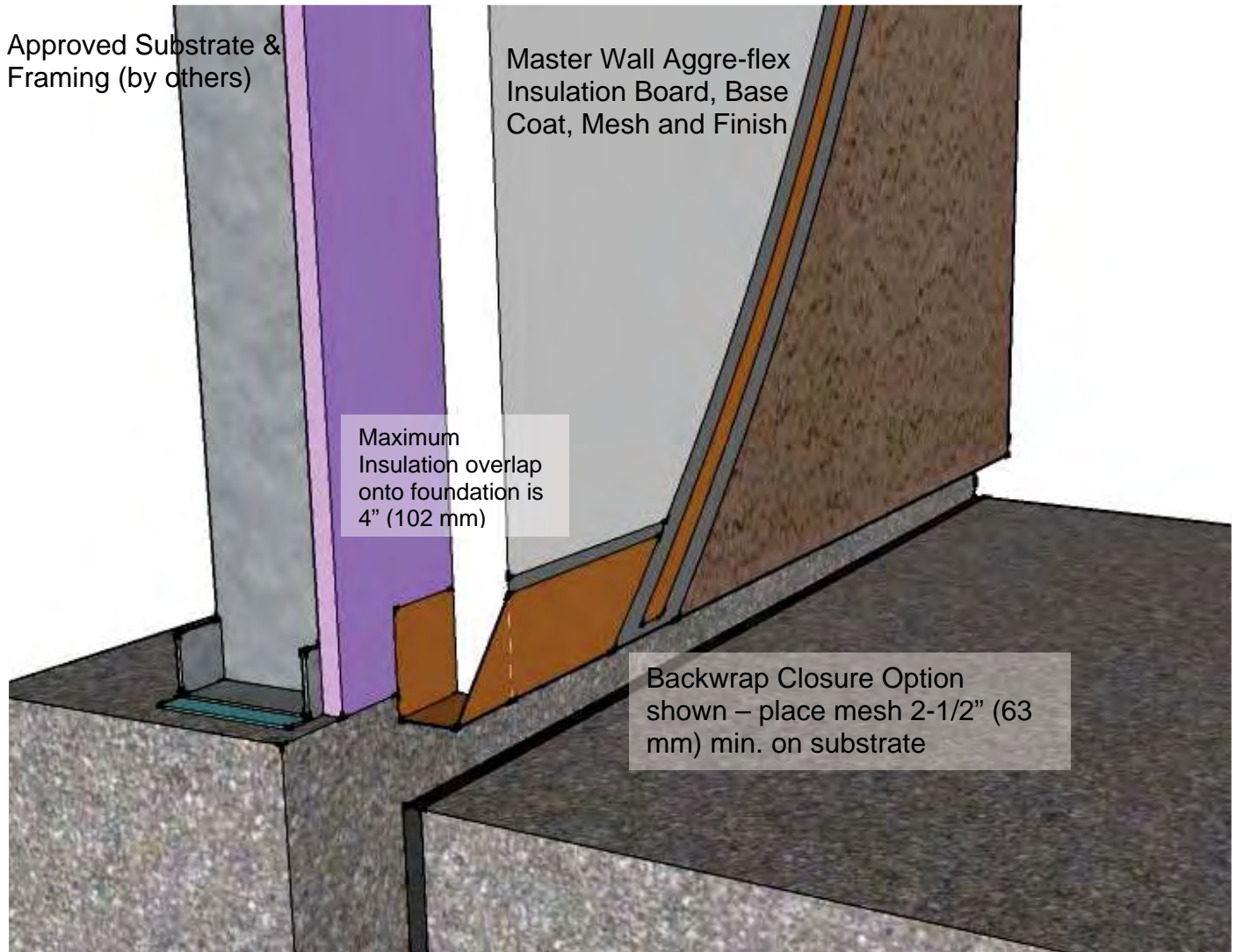

### MWAF-06 PAVEMENT/WALKWAY DETAIL

**Note: Keep EIFS a minimum of 2" (50 mm) above pavement, slope pavement away from building.**

These drawings relay the conceptual conditions of the Aggre-flex EIFS and are not the construction drawings. Ultimately the design and detailing of an entire wall system is the responsibility of a professional. These details will guide the design professional in the use of Master Wall Products. Master Wall disclaims design, warranty or construction intent or responsibility.



# Aggre-flex™ EIFS

## Conceptual Details

Corporate • P.O. Box 397 • Fortson • Georgia • 31808 • 800-755-0825 • FAX 706-569-6704

Technical • 800-760-2861 • FAX 734-433-0930

Approved Substrate &  
Framing (by others)

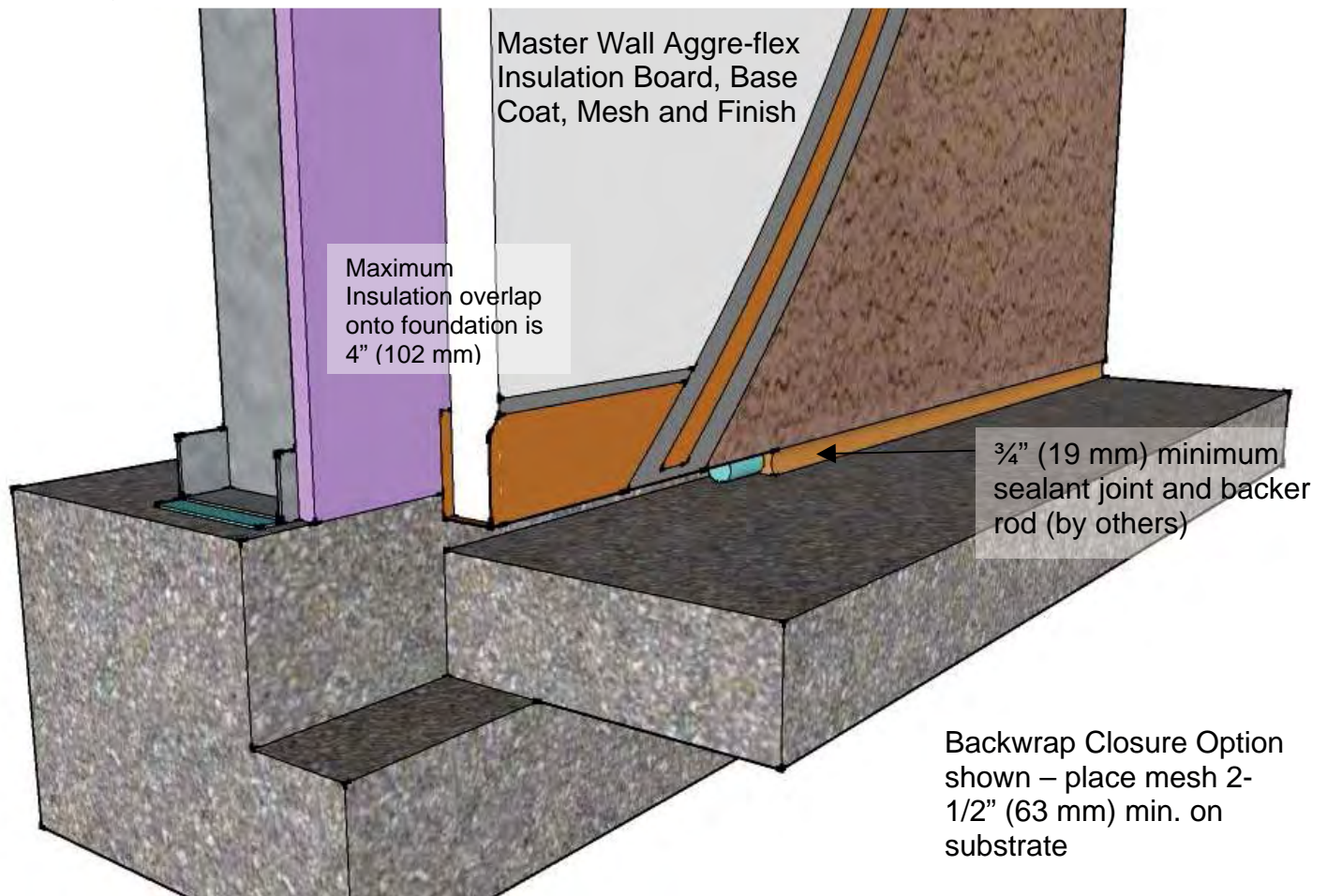

### MWAF-07 SUPPORTED PORCH DETAIL

**Note: Keep EIFS a minimum of 3/4" (19 mm) above supported porch, slope away from building.**

These drawings relay the conceptual conditions of the Aggre-flex EIFS and are not the construction drawings. Ultimately the design and detailing of an entire wall system is the responsibility of a professional. These details will guide the design professional in the use of Master Wall Products. Master Wall disclaims design, warranty or construction intent or responsibility.



# Aggre-flex™ EIFS

## Conceptual Details

Corporate • P.O. Box 397 • Fortson • Georgia • 31808 • 800-755-0825 • FAX 706-569-6704

Technical • 800-760-2861 • FAX 734-433-0930

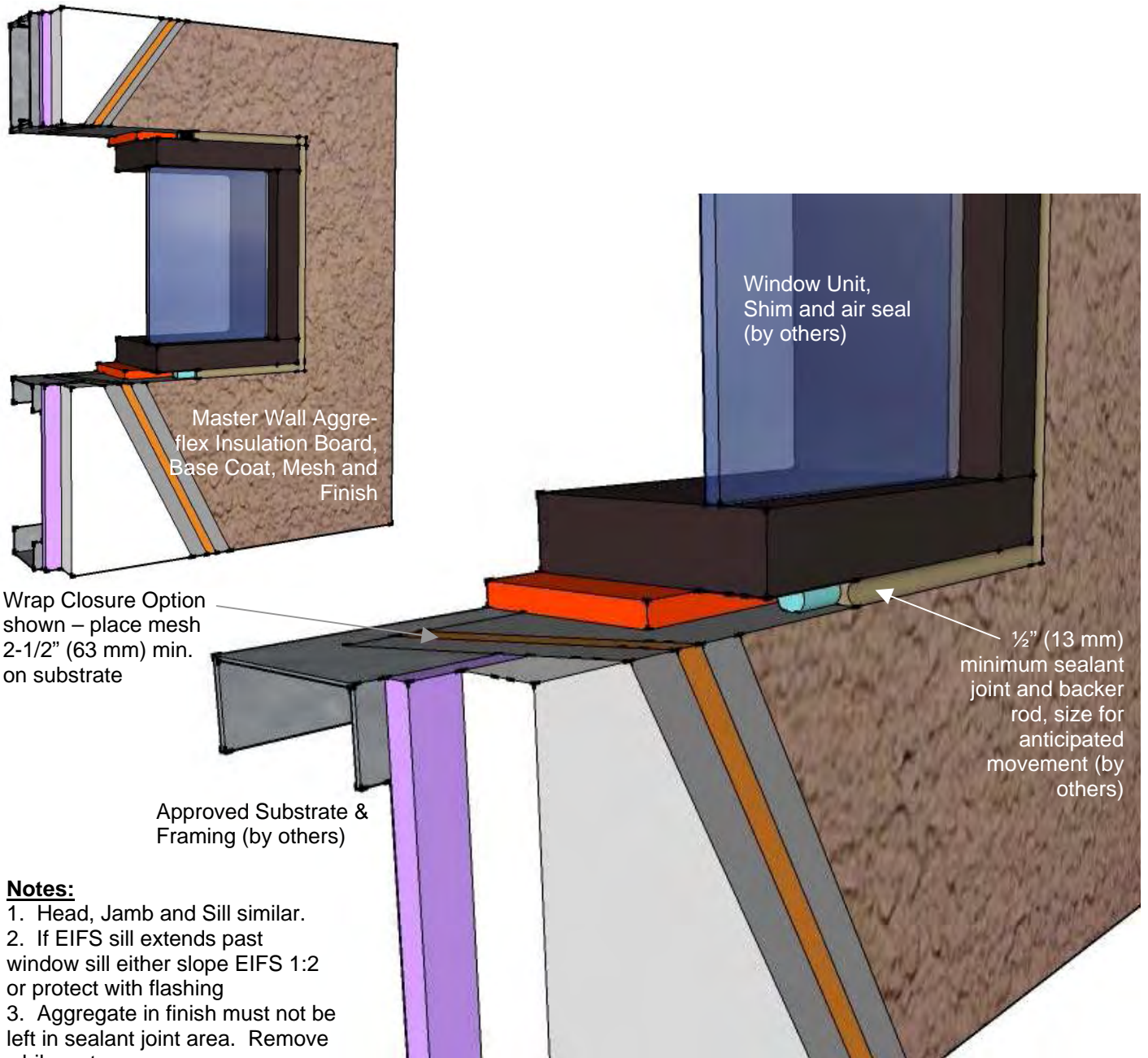

### Notes:

1. Head, Jamb and Sill similar.
2. If EIFS sill extends past window sill either slope EIFS 1:2 or protect with flashing
3. Aggregate in finish must not be left in sealant joint area. Remove while wet.

## MWAF-08 STOREFRONT WINDOW DETAIL

These drawings relay the conceptual conditions of the Aggre-flex EIFS and are not the construction drawings. Ultimately the design and detailing of an entire wall system is the responsibility of a professional. These details will guide the design professional in the use of Master Wall Products. Master Wall disclaims design, warranty or construction intent or responsibility.



# Aggre-flex™ EIFS

## Conceptual Details

Corporate • P.O. Box 397 • Fortson • Georgia • 31808 • 800-755-0825 • FAX 706-569-6704

Technical • 800-760-2861 • FAX 734-433-0930

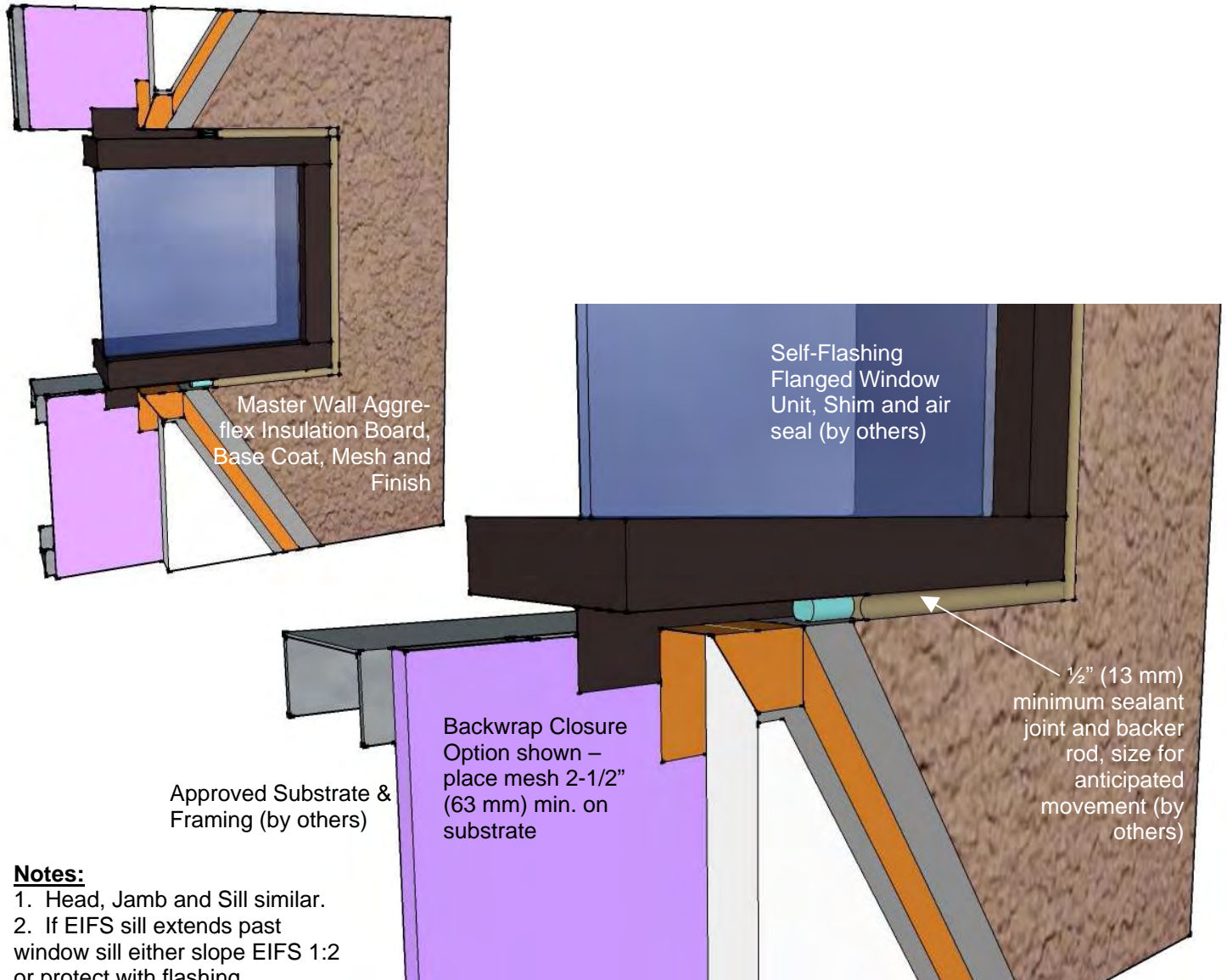

### Notes:

1. Head, Jamb and Sill similar.
2. If EIFS sill extends past window sill either slope EIFS 1:2 or protect with flashing
3. Aggregate in finish must not be left in sealant joint area. Remove while wet.

## MWAF-09 FLANGED WINDOW DETAIL

These drawings relay the conceptual conditions of the Aggre-flex EIFS and are not the construction drawings. Ultimately the design and detailing of an entire wall system is the responsibility of a professional. These details will guide the design professional in the use of Master Wall Products. Master Wall disclaims design, warranty or construction intent or responsibility.



# Aggre-flex™ EIFS

## Conceptual Details

Corporate • P.O. Box 397 • Fortson • Georgia • 31808 • 800-755-0825 • FAX 706-569-6704

Technical • 800-760-2861 • FAX 734-433-0930

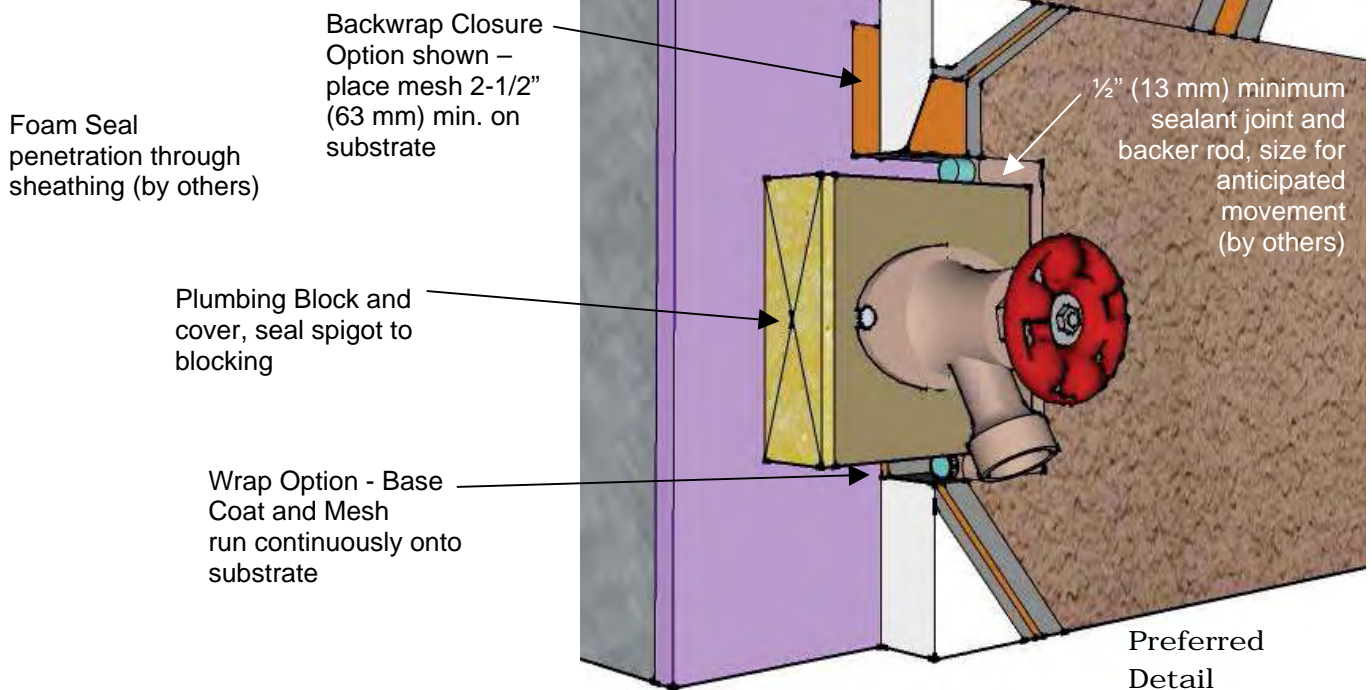
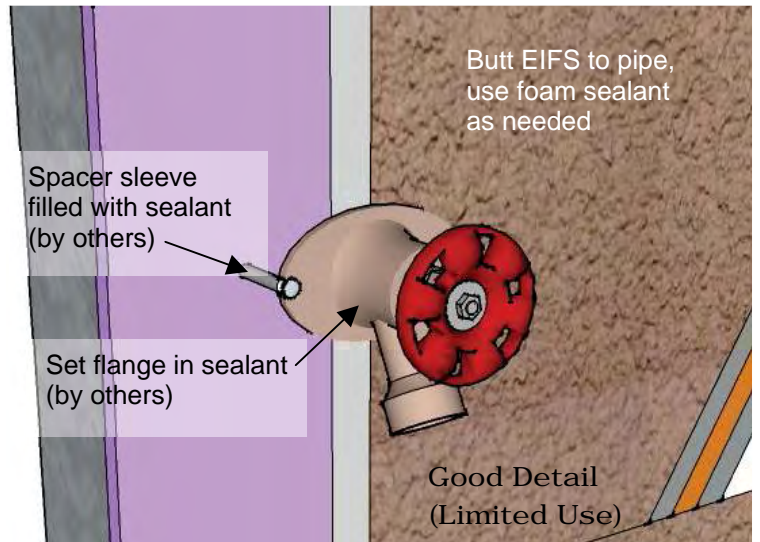
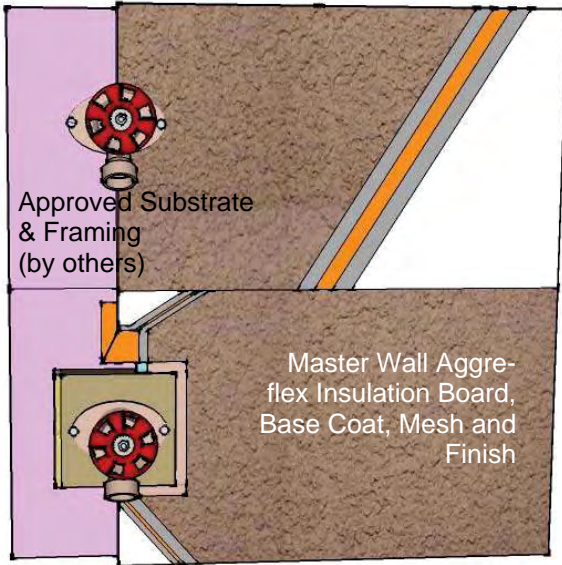

### MWAF-10 PLUMBING SPIGOT DETAIL

These drawings relay the conceptual conditions of the Aggre-flex EIFS and are not the construction drawings. Ultimately the design and detailing of an entire wall system is the responsibility of a professional. These details will guide the design professional in the use of Master Wall Products. Master Wall disclaims design, warranty or construction intent or responsibility.



# Aggre-flex™ EIFS

## Conceptual Details

Corporate • P.O. Box 397 • Fortson • Georgia • 31808 • 800-755-0825 • FAX 706-569-6704

Technical • 800-760-2861 • FAX 734-433-0930

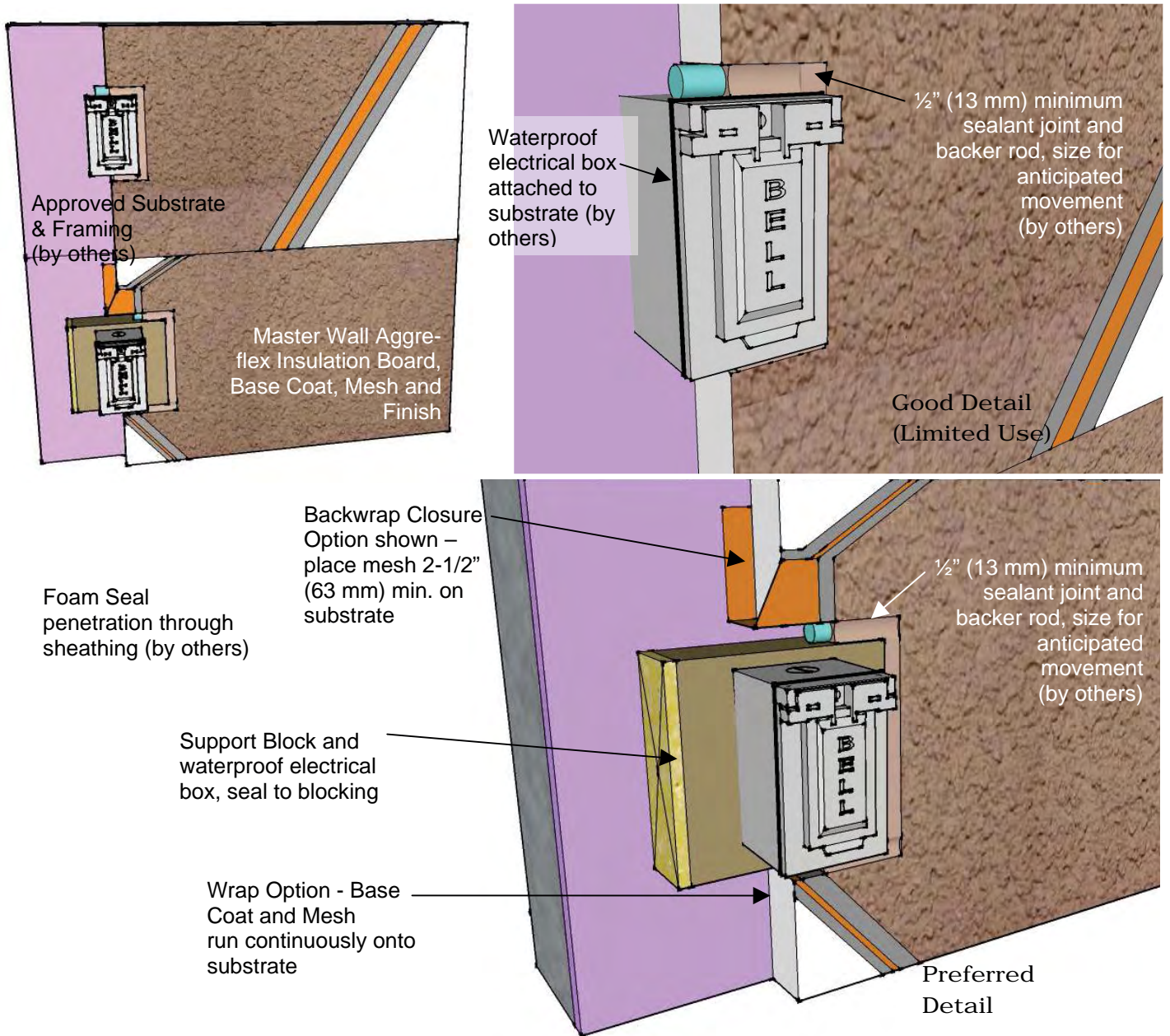

### MWAF-11 ELECTRICAL OUTLET DETAIL

These drawings relay the conceptual conditions of the Aggre-flex EIFS and are not the construction drawings. Ultimately the design and detailing of an entire wall system is the responsibility of a professional. These details will guide the design professional in the use of Master Wall Products. Master Wall disclaims design, warranty or construction intent or responsibility.



# Aggre-flex™ EIFS

## Conceptual Details

Corporate • P.O. Box 397 • Fortson • Georgia • 31808 • 800-755-0825 • FAX 706-569-6704

Technical • 800-760-2861 • FAX 734-433-0930

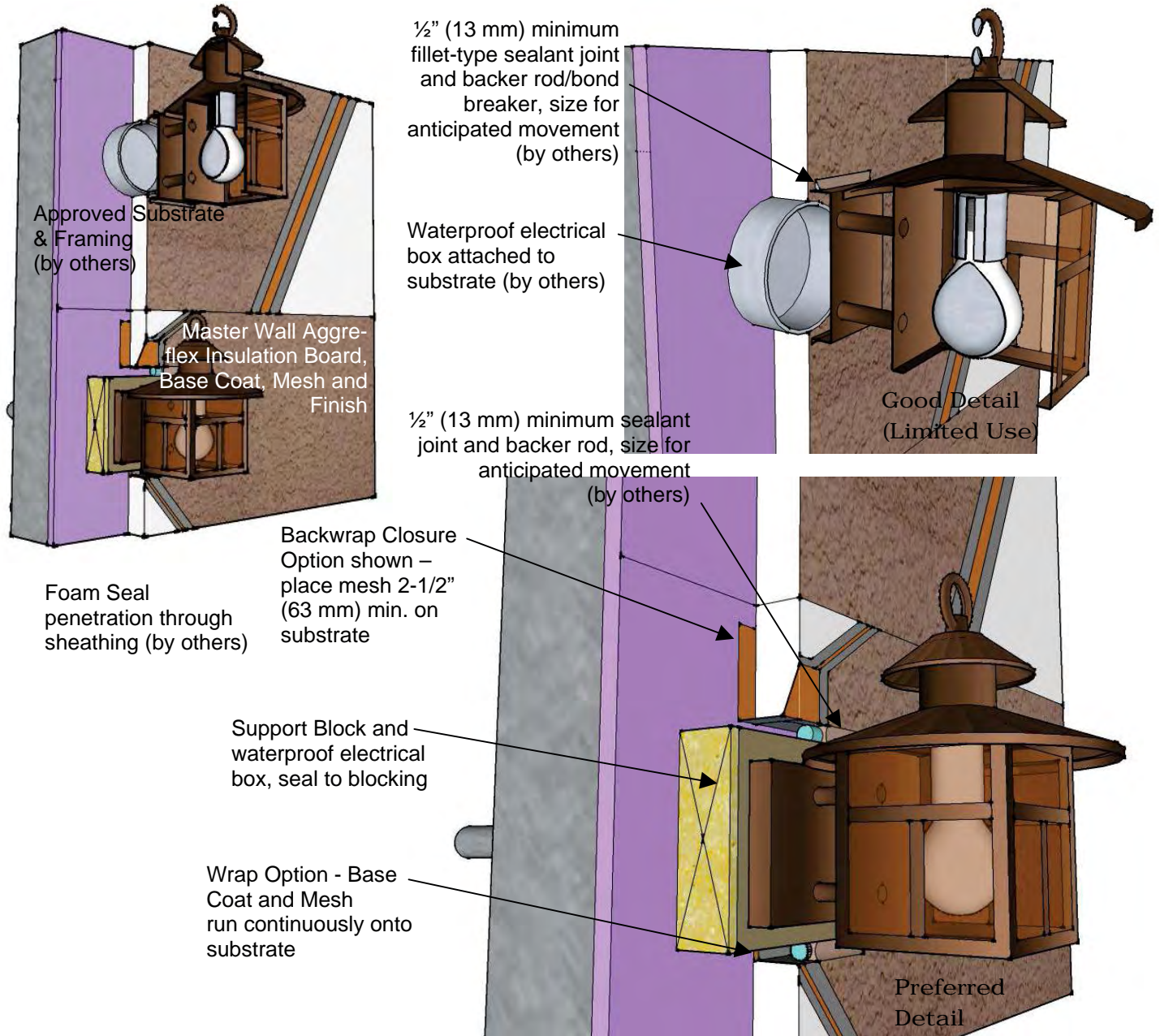

### MWAF-12 LIGHT FIXTURE DETAIL

These drawings relay the conceptual conditions of the Aggre-flex EIFS and are not the construction drawings. Ultimately the design and detailing of an entire wall system is the responsibility of a professional. These details will guide the design professional in the use of Master Wall Products. Master Wall disclaims design, warranty or construction intent or responsibility.



# Aggre-flex™ EIFS

## Conceptual Details

Corporate • P.O. Box 397 • Fortson • Georgia • 31808 • 800-755-0825 • FAX 706-569-6704

Technical • 800-760-2861 • FAX 734-433-0930

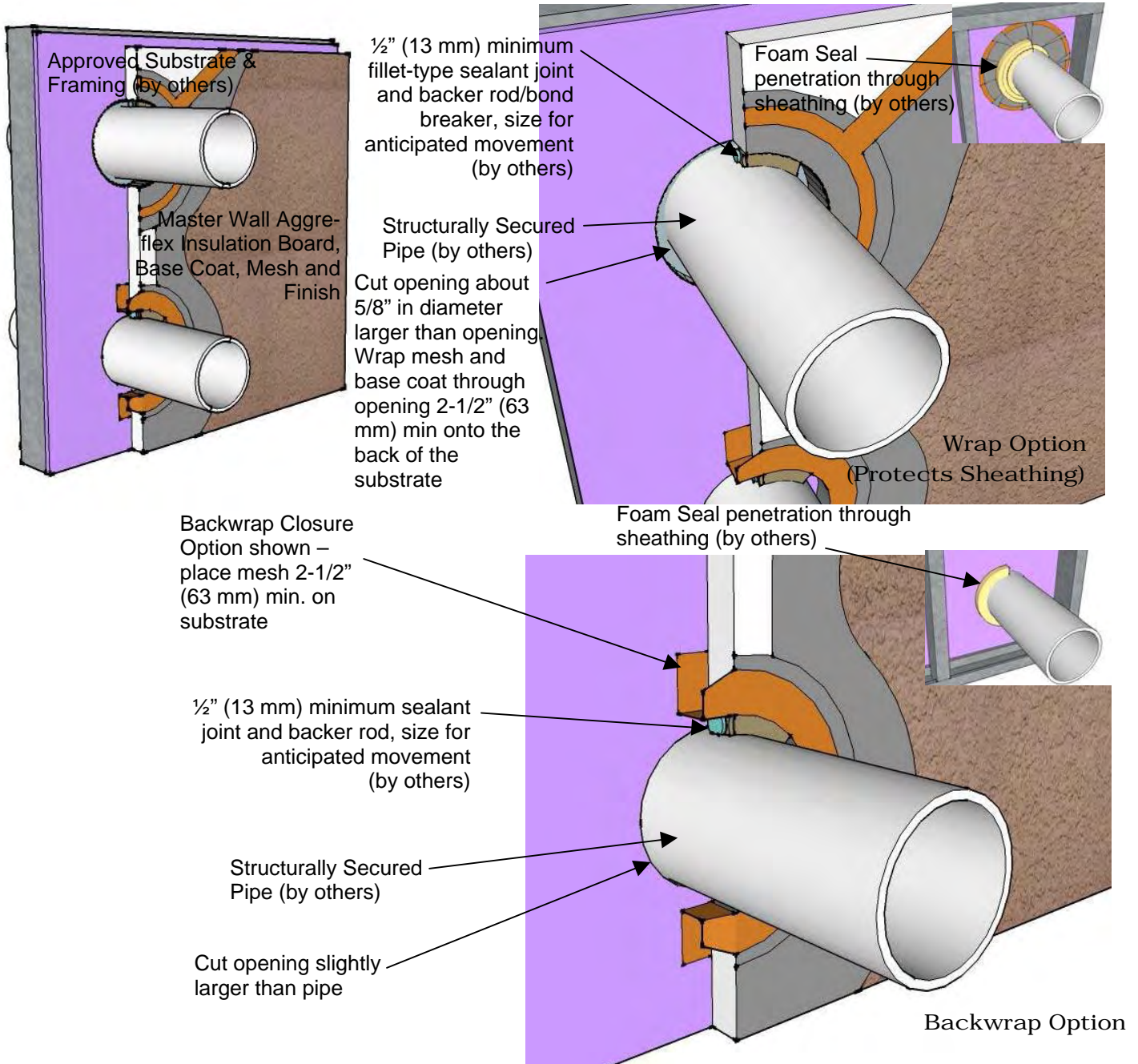

### MWAF-13 PIPE PENETRATION DETAIL

These drawings relay the conceptual conditions of the Aggre-flex EIFS and are not the construction drawings. Ultimately the design and detailing of an entire wall system is the responsibility of a professional. These details will guide the design professional in the use of Master Wall Products. Master Wall disclaims design, warranty or construction intent or responsibility.



# Aggre-flex™ EIFS

## Conceptual Details

Corporate • P.O. Box 397 • Fortson • Georgia • 31808 • 800-755-0825 • FAX 706-569-6704

Technical • 800-760-2861 • FAX 734-433-0930

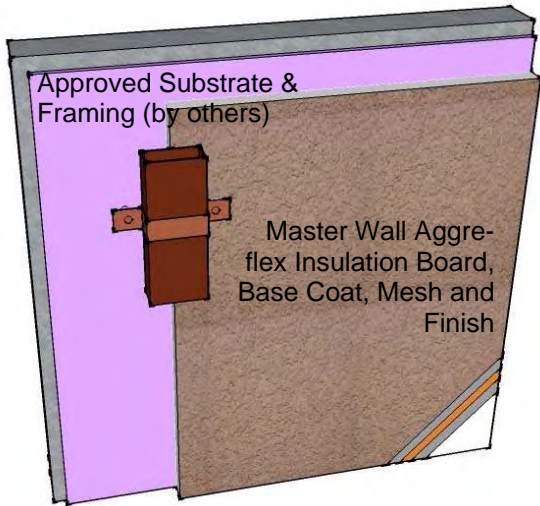

Carefully drill a hole in the EIFS the diameter of a PVC or metal structural support sleeve sized for EIFS thickness. Fill sleeve with sealant (by others)

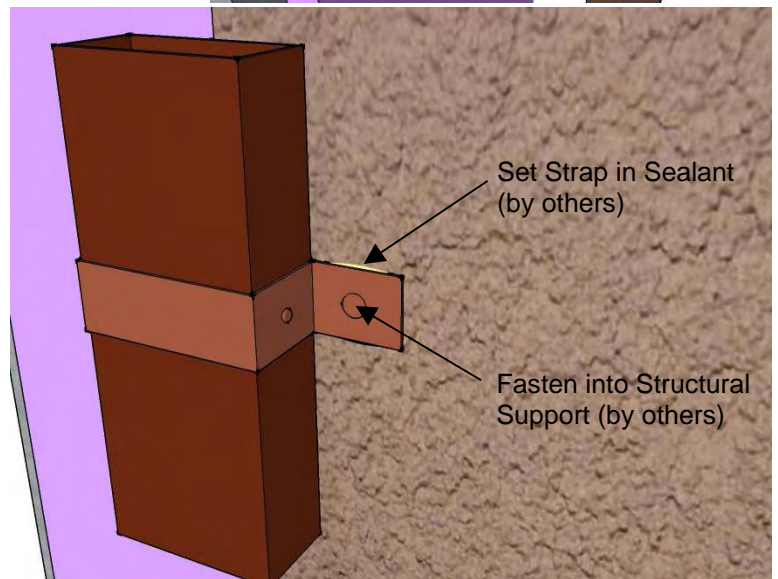
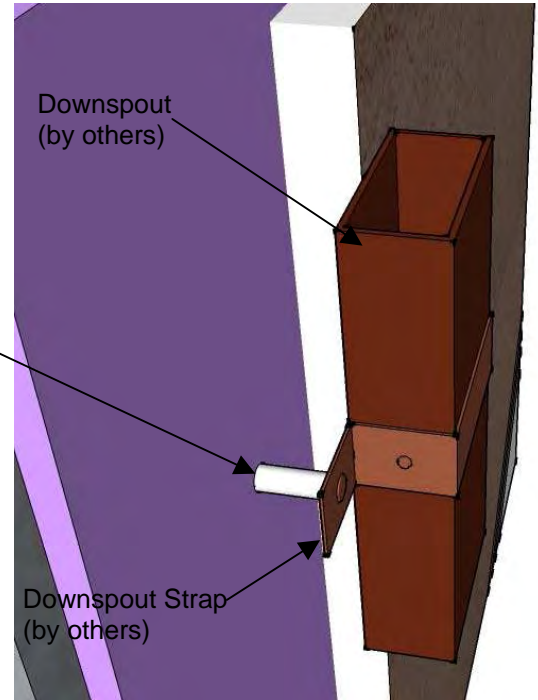

### MWAF-14 DOWNSPOUT ATTACHMENT DETAIL

These drawings relay the conceptual conditions of the Aggre-flex EIFS and are not the construction drawings. Ultimately the design and detailing of an entire wall system is the responsibility of a professional. These details will guide the design professional in the use of Master Wall Products. Master Wall disclaims design, warranty or construction intent or responsibility.



# Aggre-flex™ EIFS

## Conceptual Details

Corporate • P.O. Box 397 • Fortson • Georgia • 31808 • 800-755-0825 • FAX 706-569-6704

Technical • 800-760-2861 • FAX 734-433-0930

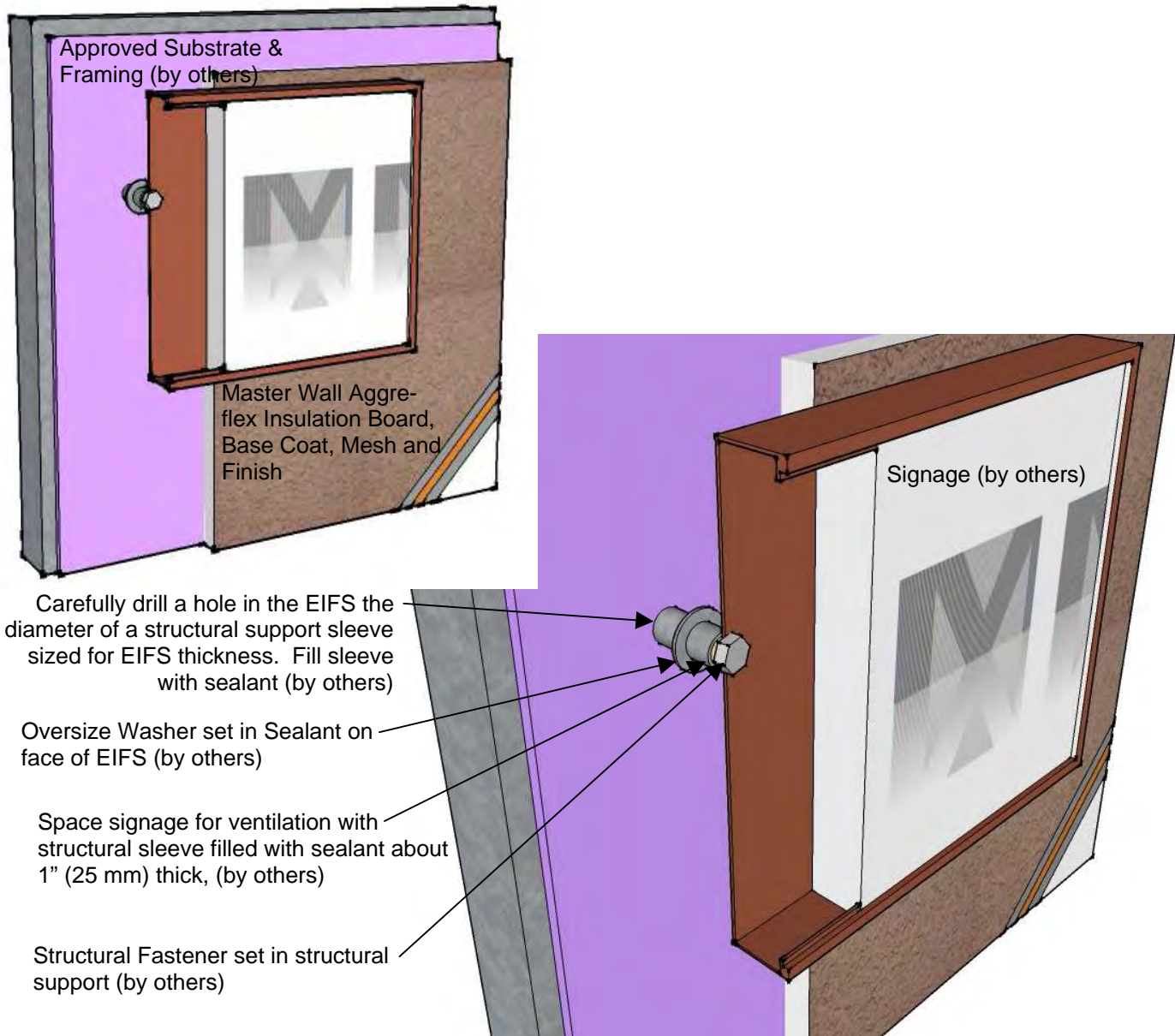

### MWAF-15 SIGNAGE ATTACHMENT DETAIL

These drawings relay the conceptual conditions of the Aggre-flex EIFS and are not the construction drawings. Ultimately the design and detailing of an entire wall system is the responsibility of a professional. These details will guide the design professional in the use of Master Wall Products. Master Wall disclaims design, warranty or construction intent or responsibility.



# Aggre-flex™ EIFS

## Conceptual Details

Corporate • P.O. Box 397 • Fortson • Georgia • 31808 • 800-755-0825 • FAX 706-569-6704

Technical • 800-760-2861 • FAX 734-433-0930

Designer to calculate movement and size sealant joint for 4x anticipated movement (by others)

Backwrap Mesh 2-1/2" (63 mm) onto substrate

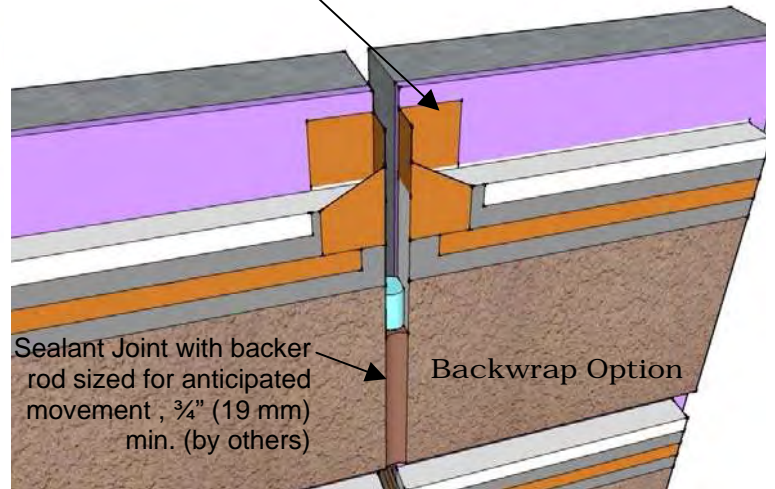
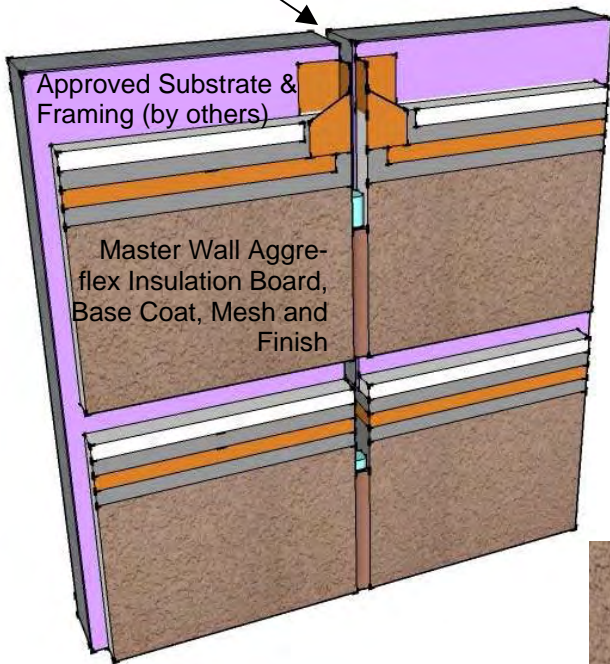

Wrap Mesh and Base Coat 2-1/2" (63 mm) onto framing

Sealant Joint with backer rod sized for anticipated movement, 3/4" (19 mm) min. (by others)

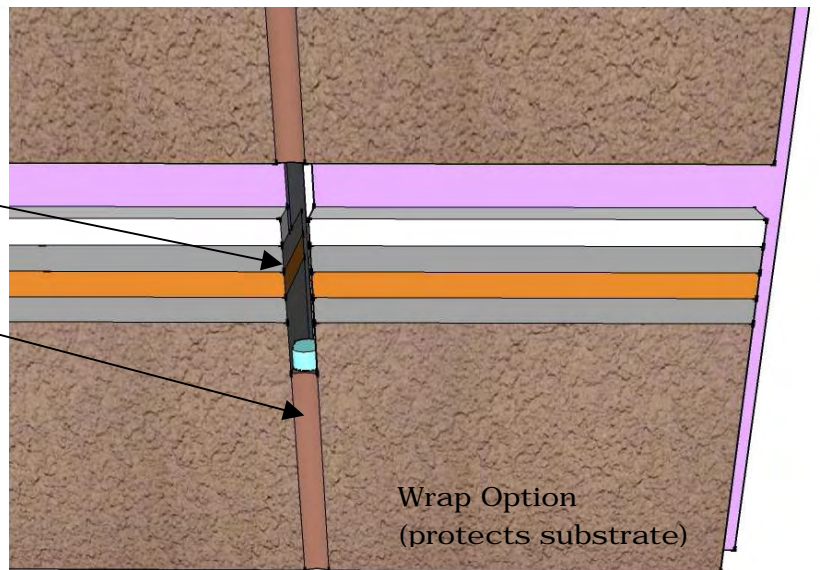

Note: Use foam sealant on interior (by others)

## MWAF-16 VERTICAL EXPANSION JOINT DETAIL

These drawings relay the conceptual conditions of the Aggre-flex EIFS and are not the construction drawings. Ultimately the design and detailing of an entire wall system is the responsibility of a professional. These details will guide the design professional in the use of Master Wall Products. Master Wall disclaims design, warranty or construction intent or responsibility.



# Aggre-flex™ EIFS

## Conceptual Details

Corporate • P.O. Box 397 • Fortson • Georgia • 31808 • 800-755-0825 • FAX 706-569-6704

Technical • 800-760-2861 • FAX 734-433-0930

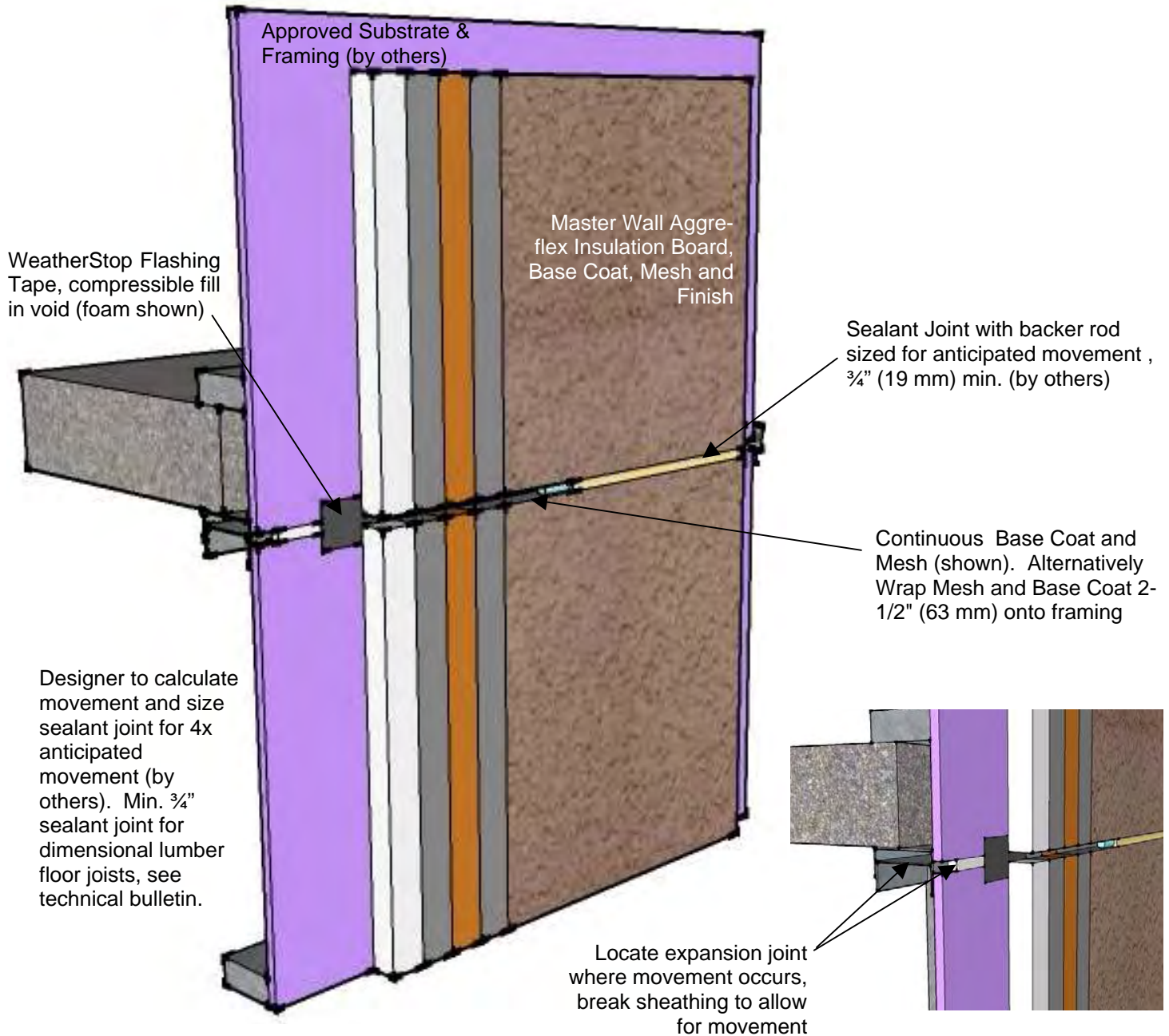

### MWAF-17 HORIZONTAL EXPANSION JOINT DETAIL

These drawings relay the conceptual conditions of the Aggre-flex EIFS and are not the construction drawings. Ultimately the design and detailing of an entire wall system is the responsibility of a professional. These details will guide the design professional in the use of Master Wall Products. Master Wall disclaims design, warranty or construction intent or responsibility.



# Aggre-flex™ EIFS

## Conceptual Details

Corporate • P.O. Box 397 • Fortson • Georgia • 31808 • 800-755-0825 • FAX 706-569-6704

Technical • 800-760-2861 • FAX 734-433-0930

Keep 3/4" (19 mm)  
min. insulation  
under joint, size  
insulation accordingly

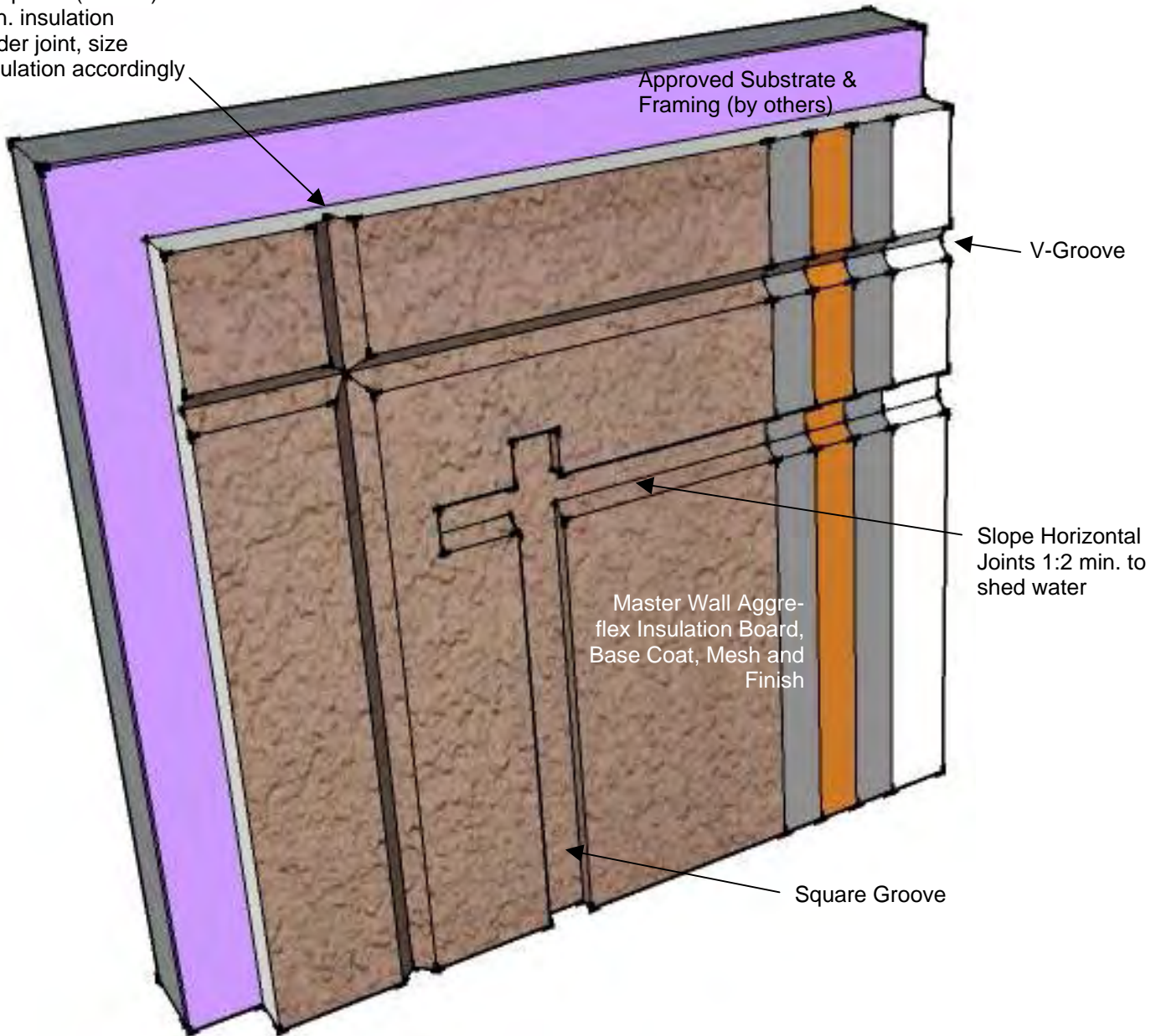

### MWAF-18 AESTHETIC JOINT DETAIL

These drawings relay the conceptual conditions of the Aggre-flex EIFS and are not the construction drawings. Ultimately the design and detailing of an entire wall system is the responsibility of a professional. These details will guide the design professional in the use of Master Wall Products. Master Wall disclaims design, warranty or construction intent or responsibility.



# Aggre-flex™ EIFS

Conceptual Details

Corporate • P.O. Box 397 • Fortson • Georgia • 31808 • 800-755-0825 • FAX 706-569-6704

Technical • 800-760-2861 • FAX 734-433-0930

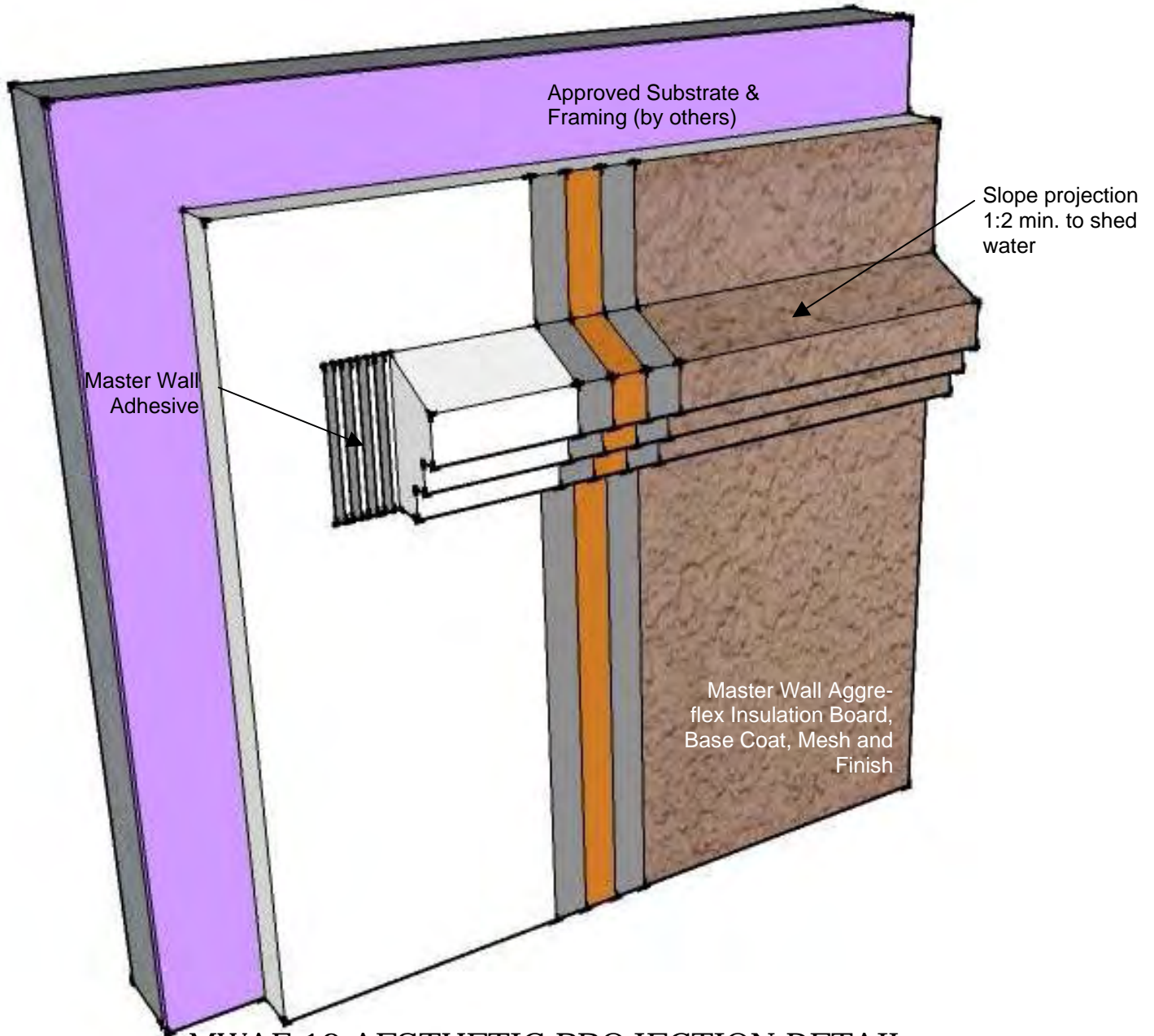

## MWAF-19 AESTHETIC PROJECTION DETAIL

These drawings relay the conceptual conditions of the Aggre-flex EIFS and are not the construction drawings. Ultimately the design and detailing of an entire wall system is the responsibility of a professional. These details will guide the design professional in the use of Master Wall Products. Master Wall disclaims design, warranty or construction intent or responsibility.



# Aggre-flex™ EIFS

## Conceptual Details

Corporate • P.O. Box 397 • Fortson • Georgia • 31808 • 800-755-0825 • FAX 706-569-6704  
Technical • 800-760-2861 • FAX 734-433-0930

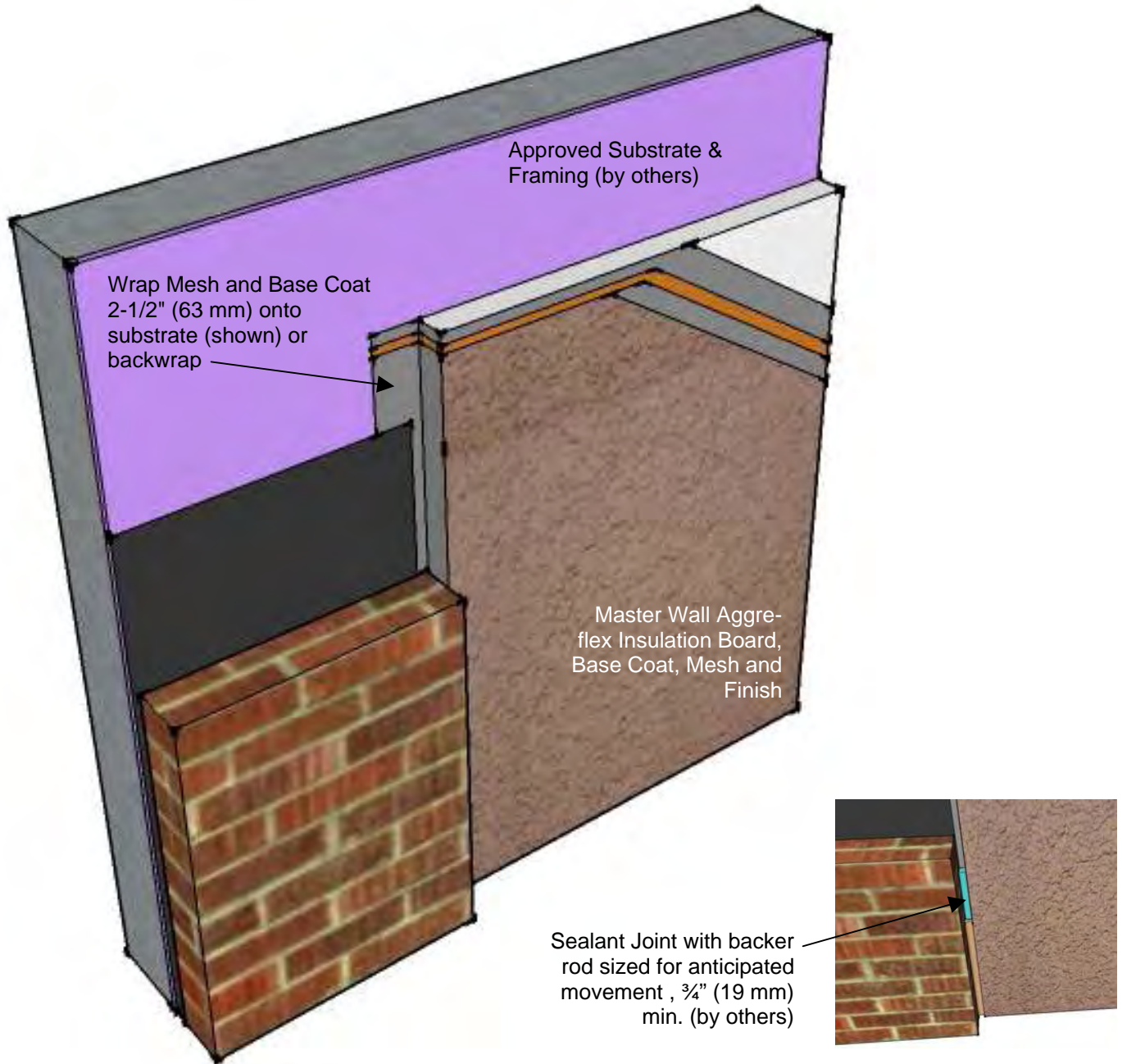

### MWAF-20 DISSIMILAR MATERIALS DETAIL

These drawings relay the conceptual conditions of the Aggre-flex EIFS and are not the construction drawings. Ultimately the design and detailing of an entire wall system is the responsibility of a professional. These details will guide the design professional in the use of Master Wall Products. Master Wall disclaims design, warranty or construction intent or responsibility.



# Aggre-flex™ EIFS

Conceptual Details

Corporate • P.O. Box 397 • Fortson • Georgia • 31808 • 800-755-0825 • FAX 706-569-6704

Technical • 800-760-2861 • FAX 734-433-0930

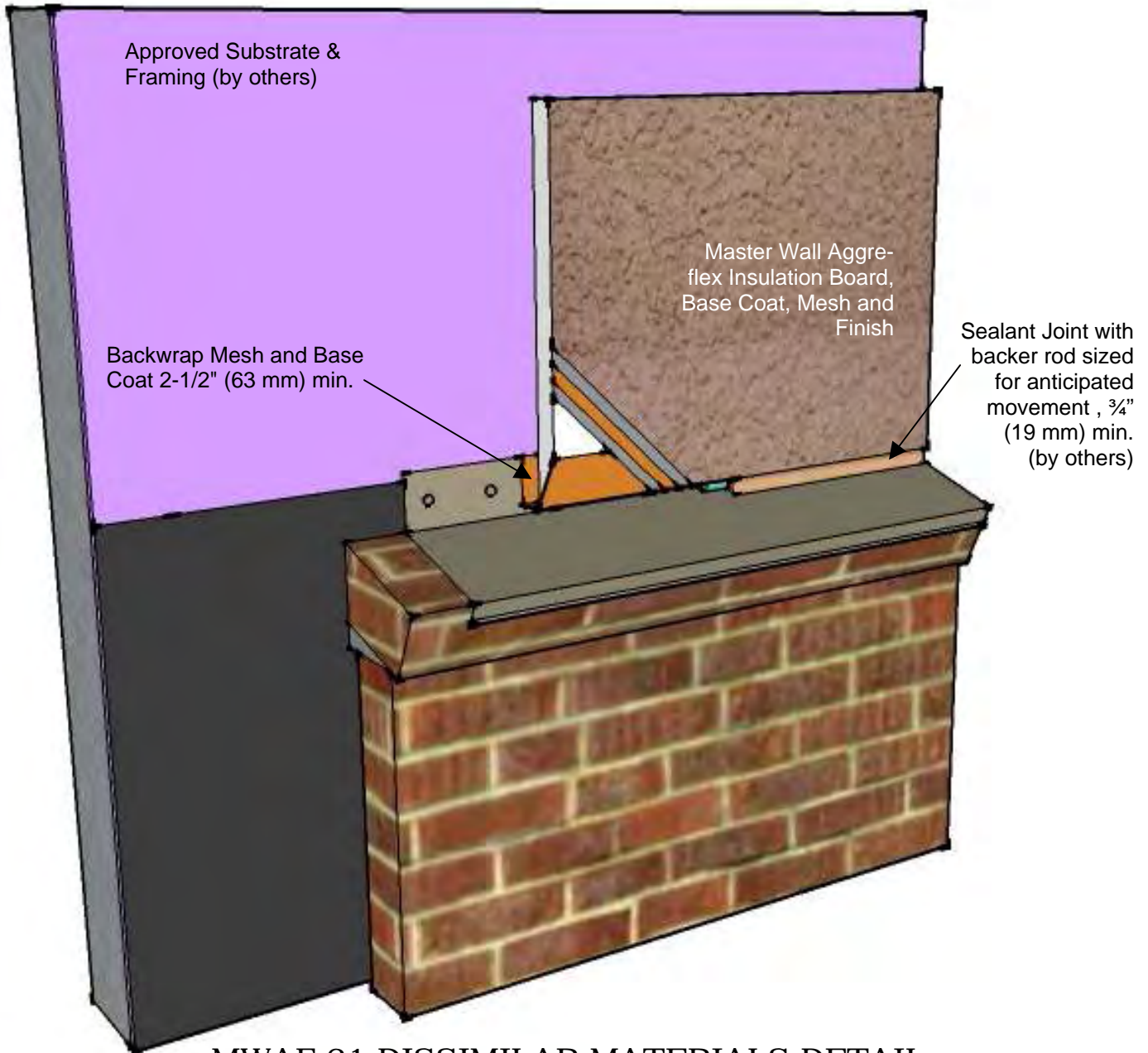

## MWAF-21 DISSIMILAR MATERIALS DETAIL

These drawings relay the conceptual conditions of the Aggre-flex EIFS and are not the construction drawings. Ultimately the design and detailing of an entire wall system is the responsibility of a professional. These details will guide the design professional in the use of Master Wall Products. Master Wall disclaims design, warranty or construction intent or responsibility.



# Aggre-flex™ EIFS

## Conceptual Details

Corporate • P.O. Box 397 • Fortson • Georgia • 31808 • 800-755-0825 • FAX 706-569-6704

Technical • 800-760-2861 • FAX 734-433-0930

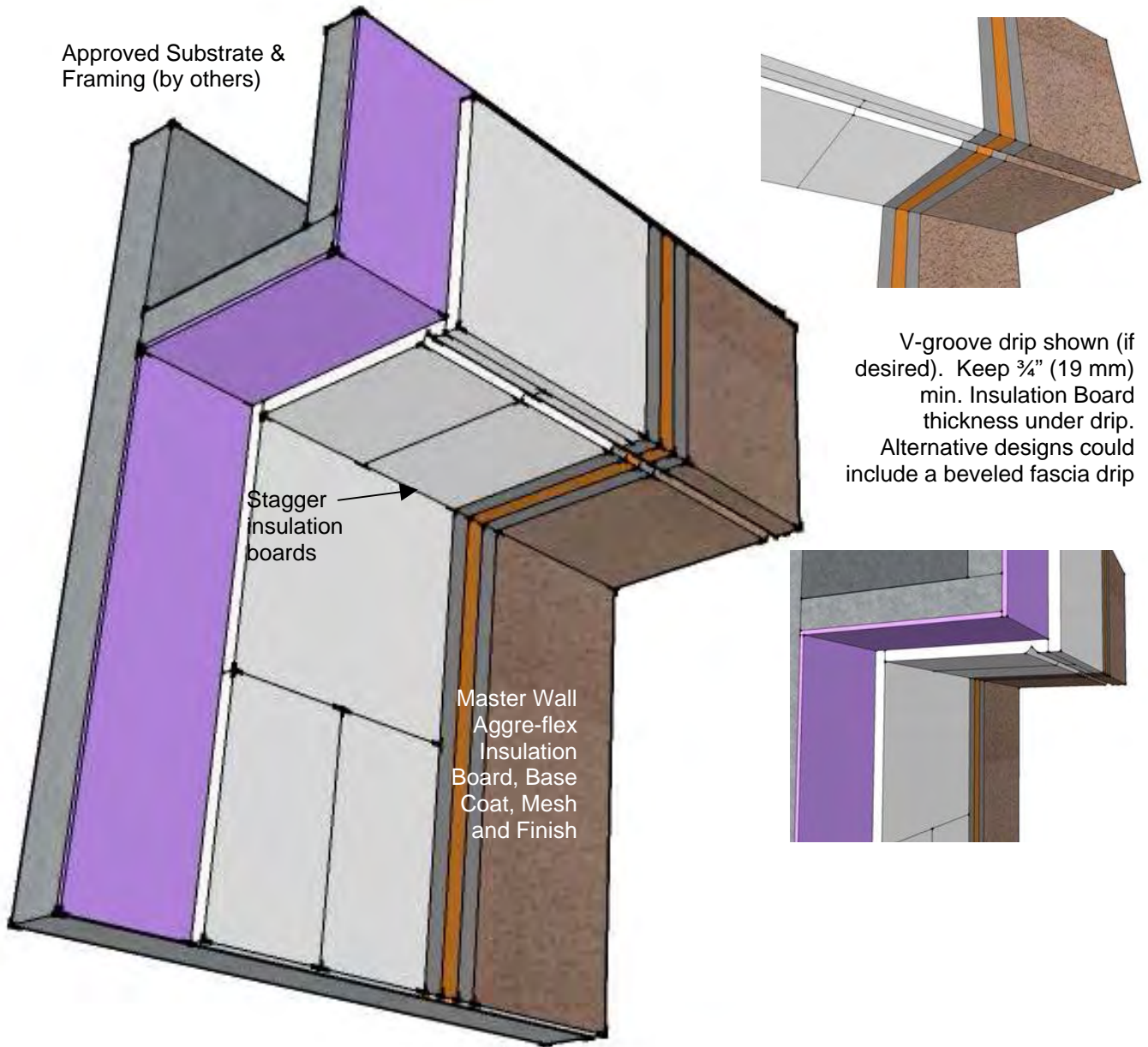

### MWAF-22 SOFFIT DETAIL

These drawings relay the conceptual conditions of the Aggre-flex EIFS and are not the construction drawings. Ultimately the design and detailing of an entire wall system is the responsibility of a professional. These details will guide the design professional in the use of Master Wall Products. Master Wall disclaims design, warranty or construction intent or responsibility.



# Aggre-flex™ EIFS

## Conceptual Details

Corporate • P.O. Box 397 • Fortson • Georgia • 31808 • 800-755-0825 • FAX 706-569-6704

Technical • 800-760-2861 • FAX 734-433-0930

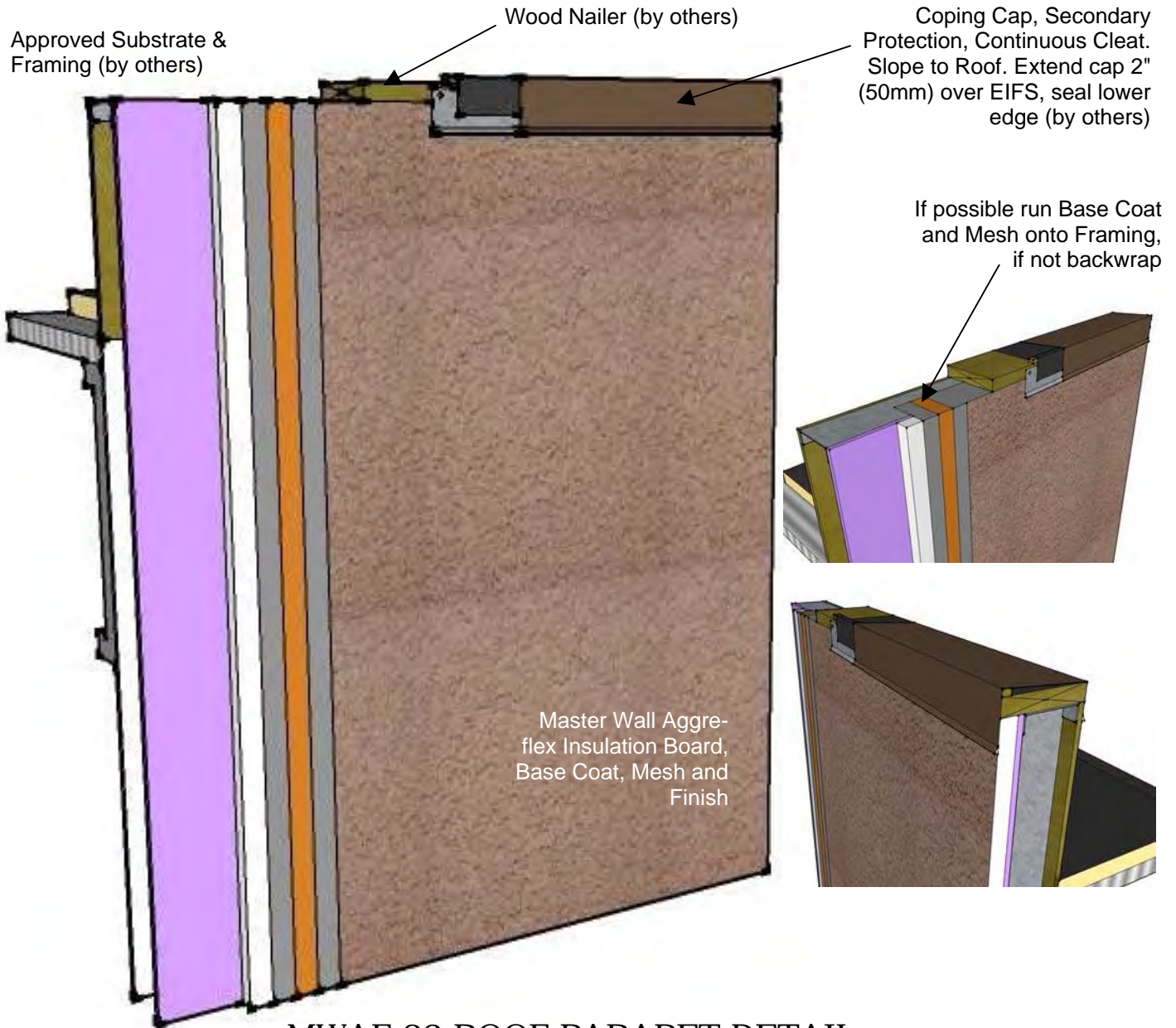

**MWAF-23 ROOF PARAPET DETAIL**

These drawings relay the conceptual conditions of the Aggre-flex EIFS and are not the construction drawings. Ultimately the design and detailing of an entire wall system is the responsibility of a professional. These details will guide the design professional in the use of Master Wall Products. Master Wall disclaims design, warranty or construction intent or responsibility.



# Aggre-flex™ EIFS

## Conceptual Details

Corporate • P.O. Box 397 • Fortson • Georgia • 31808 • 800-755-0825 • FAX 706-569-6704

Technical • 800-760-2861 • FAX 734-433-0930

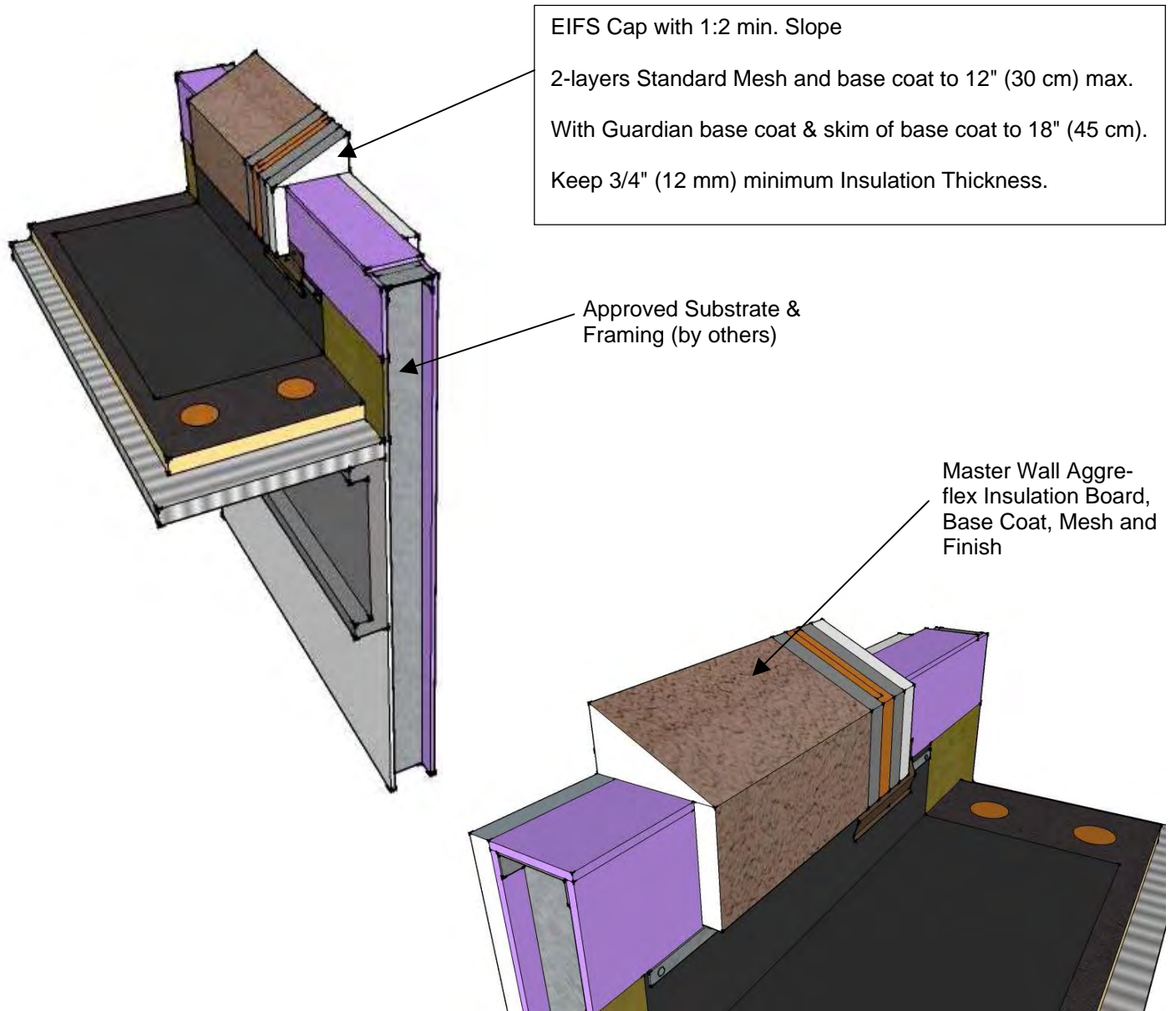

### MWAF-24 EIFS PARAPET DETAIL

These drawings relay the conceptual conditions of the Aggre-flex EIFS and are not the construction drawings. Ultimately the design and detailing of an entire wall system is the responsibility of a professional. These details will guide the design professional in the use of Master Wall Products. Master Wall disclaims design, warranty or construction intent or responsibility.



# Aggre-flex™ EIFS

Conceptual Details

Corporate • P.O. Box 397 • Fortson • Georgia • 31808 • 800-755-0825 • FAX 706-569-6704  
 Technical • 800-760-2861 • FAX 734-433-0930

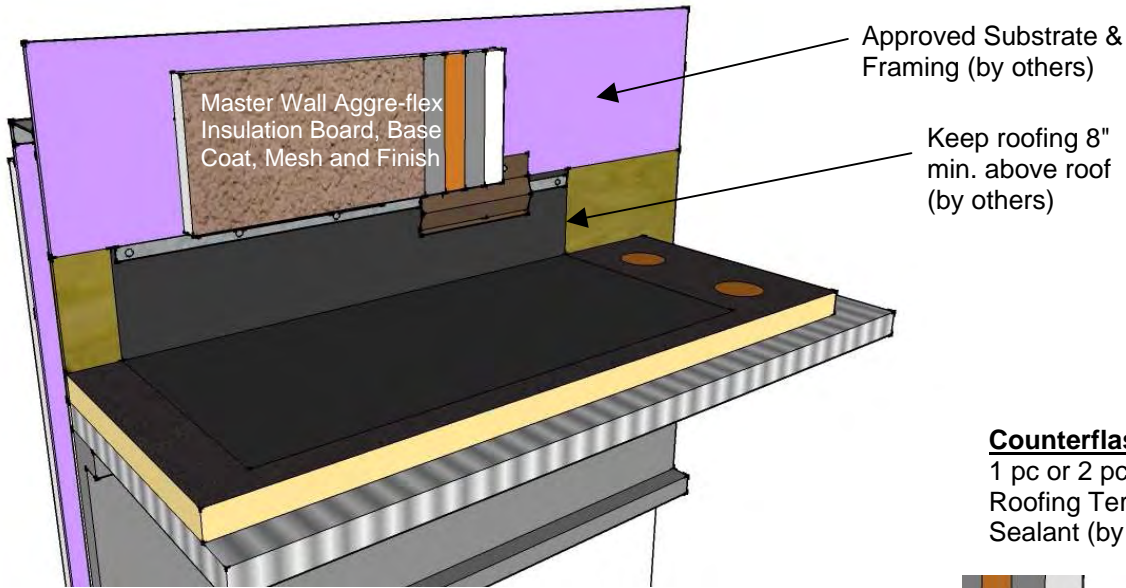

**Counterflashing Option**

1 pc or 2 pc Counterflashing,  
 Roofing Termination Bar with  
 Sealant (by others)

**Termination Bar Option**

Roofing Termination Bar with  
 Sealant (by others)

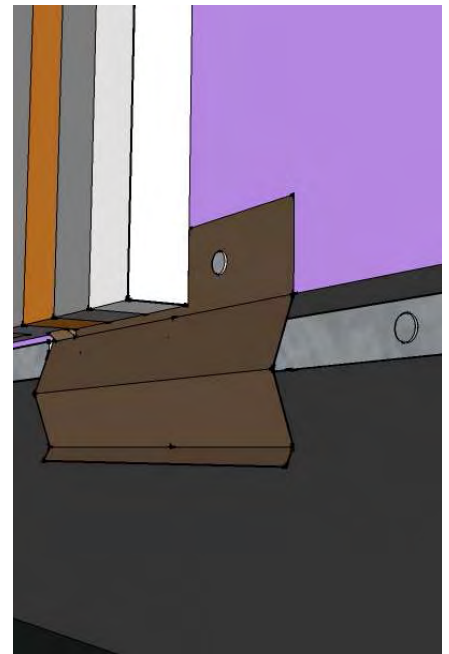
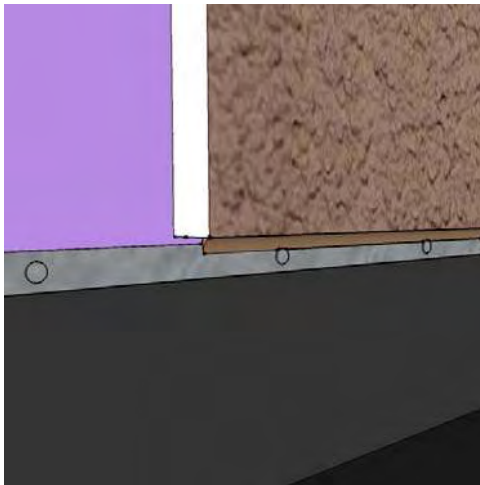

## MWAF-25 ROOF TERMINATION DETAIL

These drawings relay the conceptual conditions of the Aggre-flex EIFS and are not the construction drawings. Ultimately the design and detailing of an entire wall system is the responsibility of a professional. These details will guide the design professional in the use of Master Wall Products. Master Wall disclaims design, warranty or construction intent or responsibility.



# Aggre-flex™ EIFS

## Conceptual Details

Corporate • P.O. Box 397 • Fortson • Georgia • 31808 • 800-755-0825 • FAX 706-569-6704

Technical • 800-760-2861 • FAX 734-433-0930

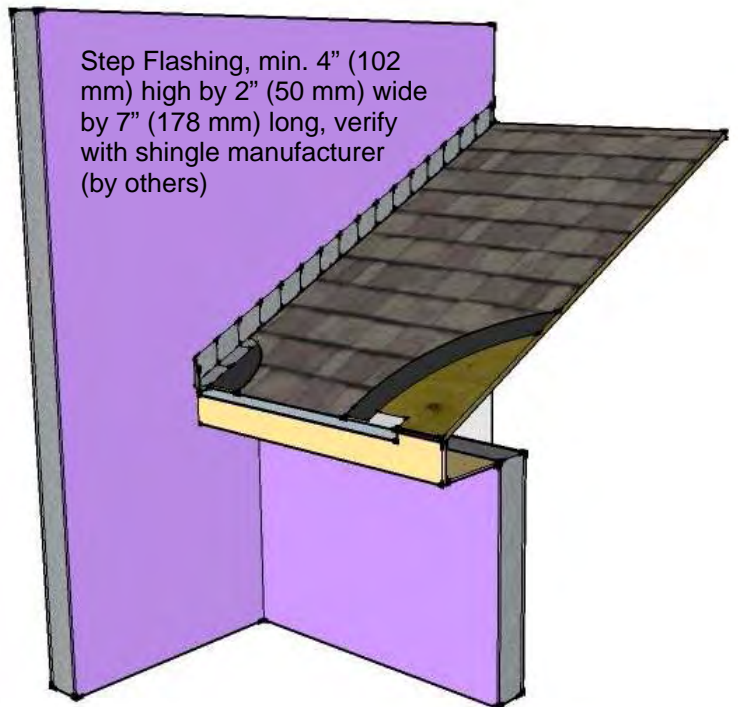
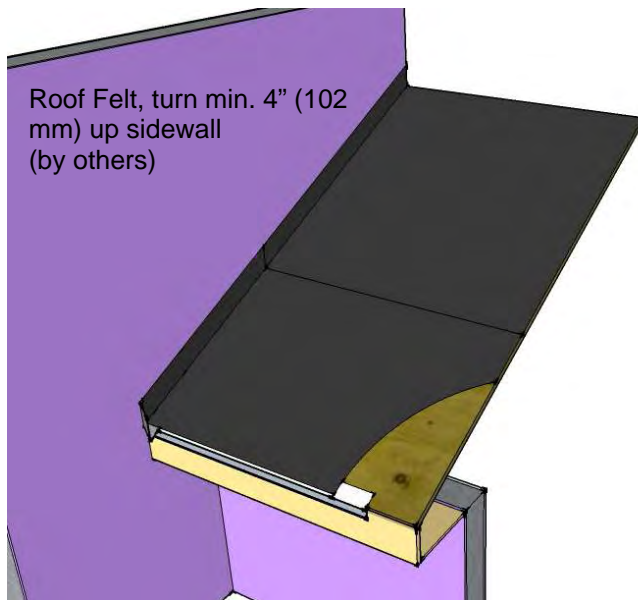
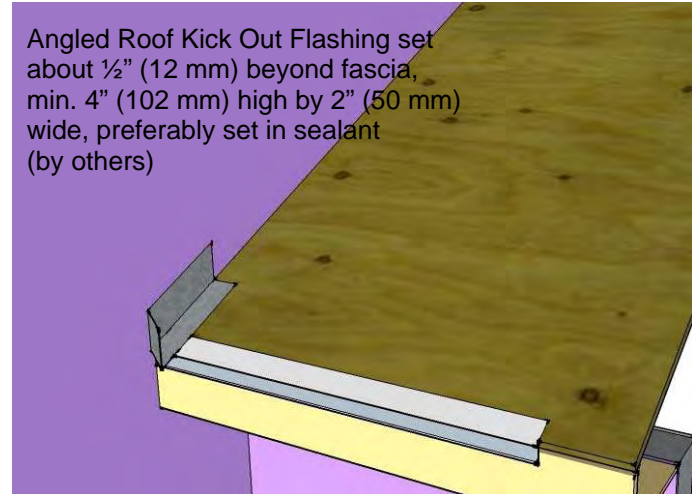

### MWAF-26 ROOF/WALL TERMINATION DETAIL (Framing & Roofing)

These drawings relay the conceptual conditions of the Aggre-flex EIFS and are not the construction drawings. Ultimately the design and detailing of an entire wall system is the responsibility of a professional. These details will guide the design professional in the use of Master Wall Products. Master Wall disclaims design, warranty or construction intent or responsibility.



# Aggre-flex™ EIFS

## Conceptual Details

Corporate • P.O. Box 397 • Fortson • Georgia • 31808 • 800-755-0825 • FAX 706-569-6704

Technical • 800-760-2861 • FAX 734-433-0930

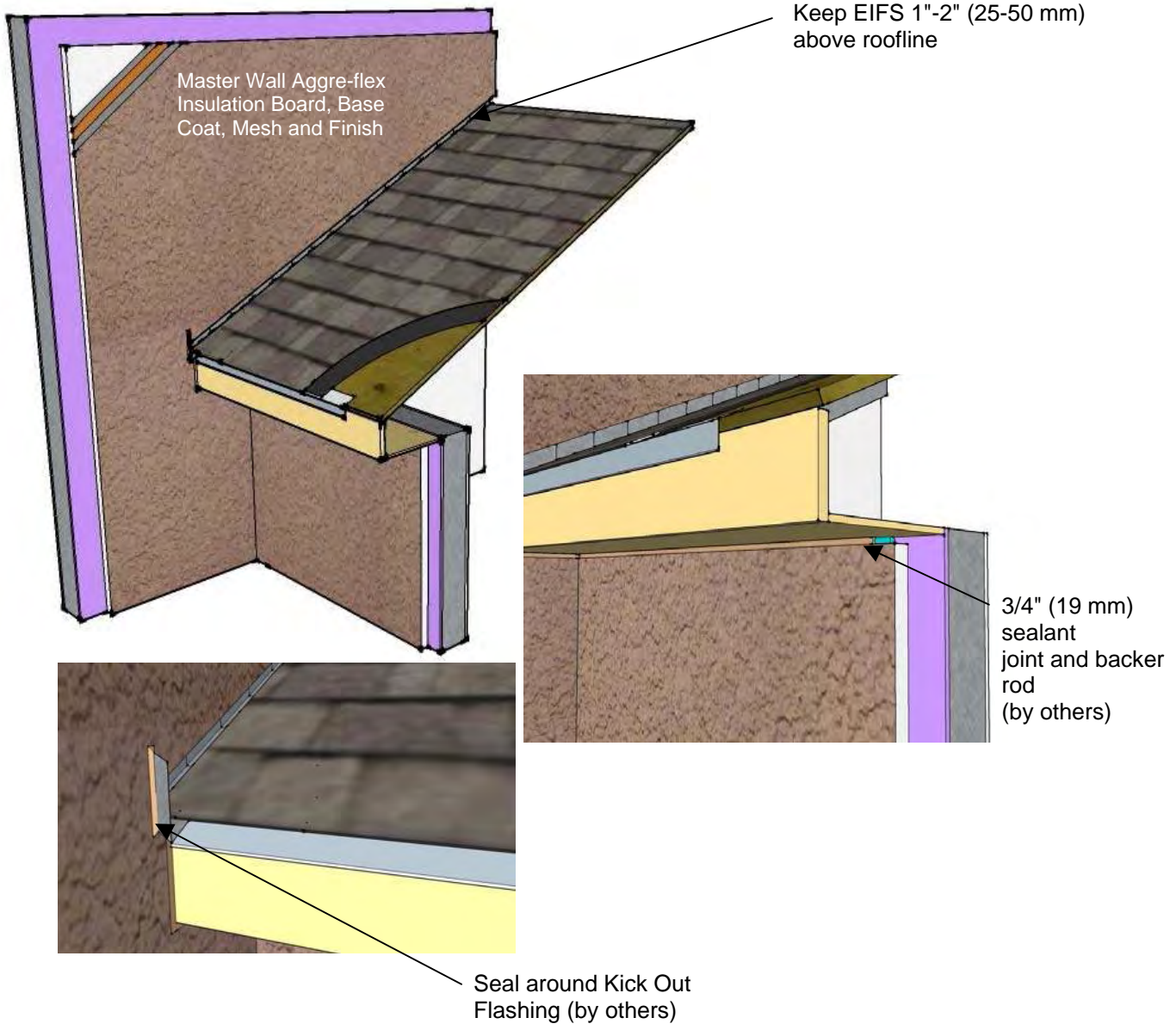

### MWAF-27 ROOF/WALL TERMINATION DETAIL (EIFS & Sealant)

These drawings relay the conceptual conditions of the Aggre-flex EIFS and are not the construction drawings. Ultimately the design and detailing of an entire wall system is the responsibility of a professional. These details will guide the design professional in the use of Master Wall Products. Master Wall disclaims design, warranty or construction intent or responsibility.



# Aggre-flex™ EIFS

## Conceptual Details

Corporate • P.O. Box 397 • Fortson • Georgia • 31808 • 800-755-0825 • FAX 706-569-6704

Technical • 800-760-2861 • FAX 734-433-0930

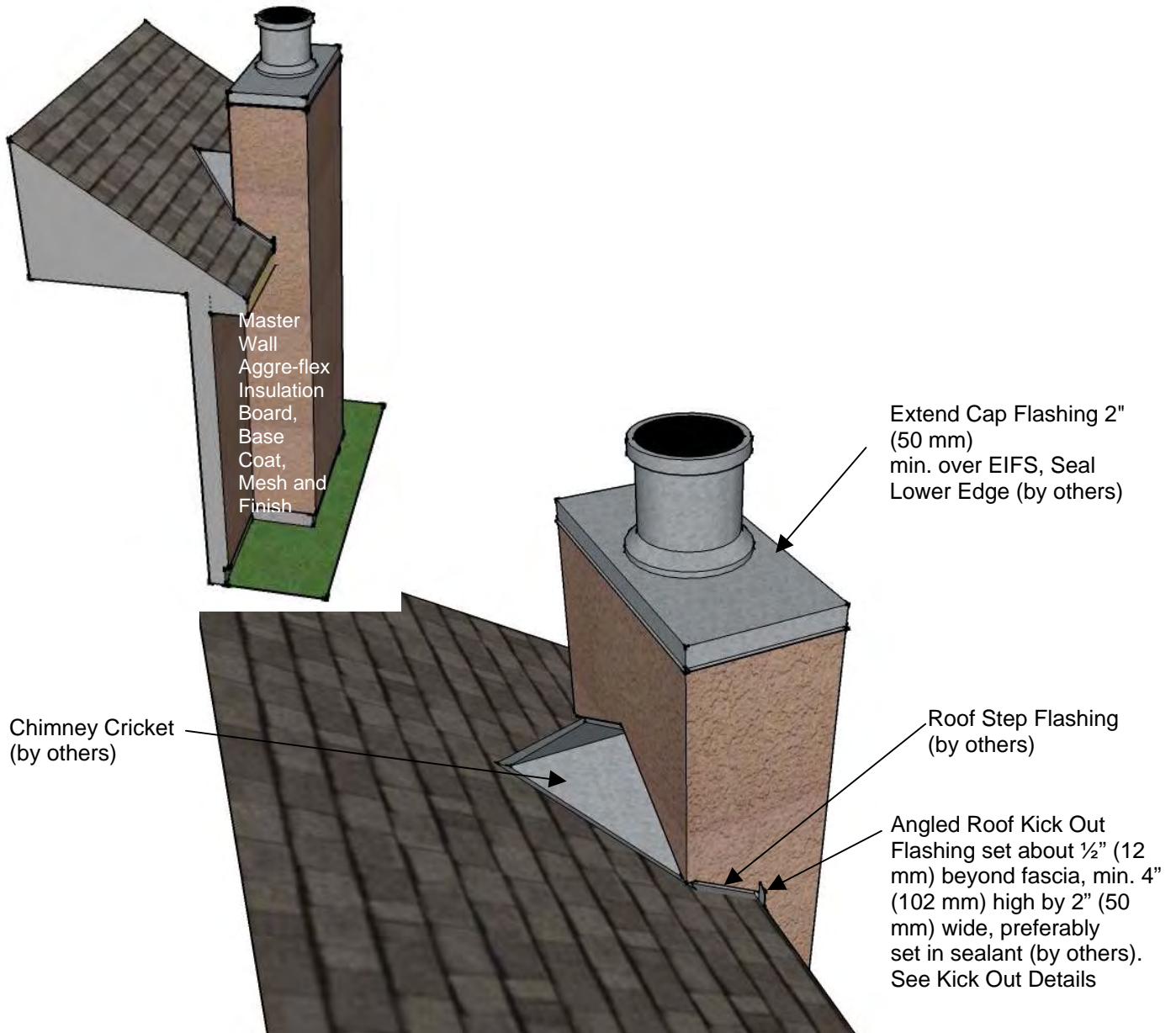

### MWAF-28 CHIMNEY FLASHING DETAIL

These drawings relay the conceptual conditions of the Aggre-flex EIFS and are not the construction drawings. Ultimately the design and detailing of an entire wall system is the responsibility of a professional. These details will guide the design professional in the use of Master Wall Products. Master Wall disclaims design, warranty or construction intent or responsibility.