

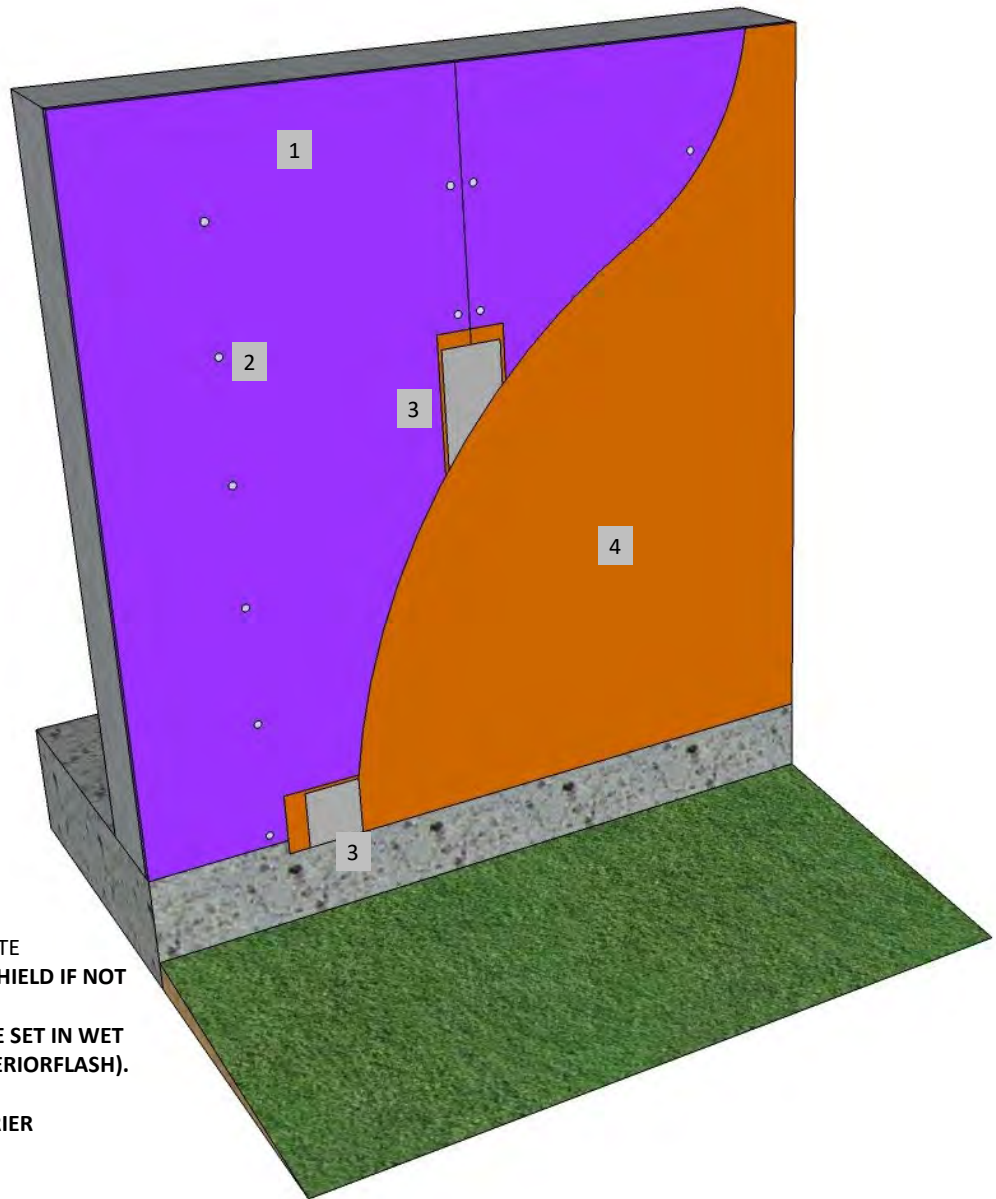

**Master Wall Inc.**  
Building a Culture of Excellence

ROLLERSHIELD LAB

SYSTEM DETAIL



1. FRAMING & APPROVED SUBSTRATE
2. SPOT FASTENERS WITH ROLLERSHIELD IF NOT FLUSH
3. SUPERIORSHIELD FLASHING TAPE SET IN WET ROLLERSHIELD (ALTERNATE SUPERIORFLASH). LAP SPLICES 2" (51 MM) MIN.
4. ROLLERSHIELD AIR/WATER BARRIER

**RSLAB-01 APPLICATION ON SHEATHING**

**M Master Wall Inc.**  
Building a Culture of Excellence

PO Box 397 · Fortson · GA · 31808 · 800-755-0825 · masterwall.com

These drawings relay the conceptual conditions of Master Wall® Systems and are not the construction drawings. Ultimately the design and detailing of an entire wall system is the responsibility of a professional. These details will guide the design professional in the use of Master Wall® Products. Master Wall disclaims design, warranty or construction intent or responsibility. Bold or Brand Name = Master Wall® Product. ©2025 Master Wall Inc.®



**Master Wall Inc.®**  
Building a Culture of Excellence

ROLLERSHIELD LAB

SYSTEM DETAIL

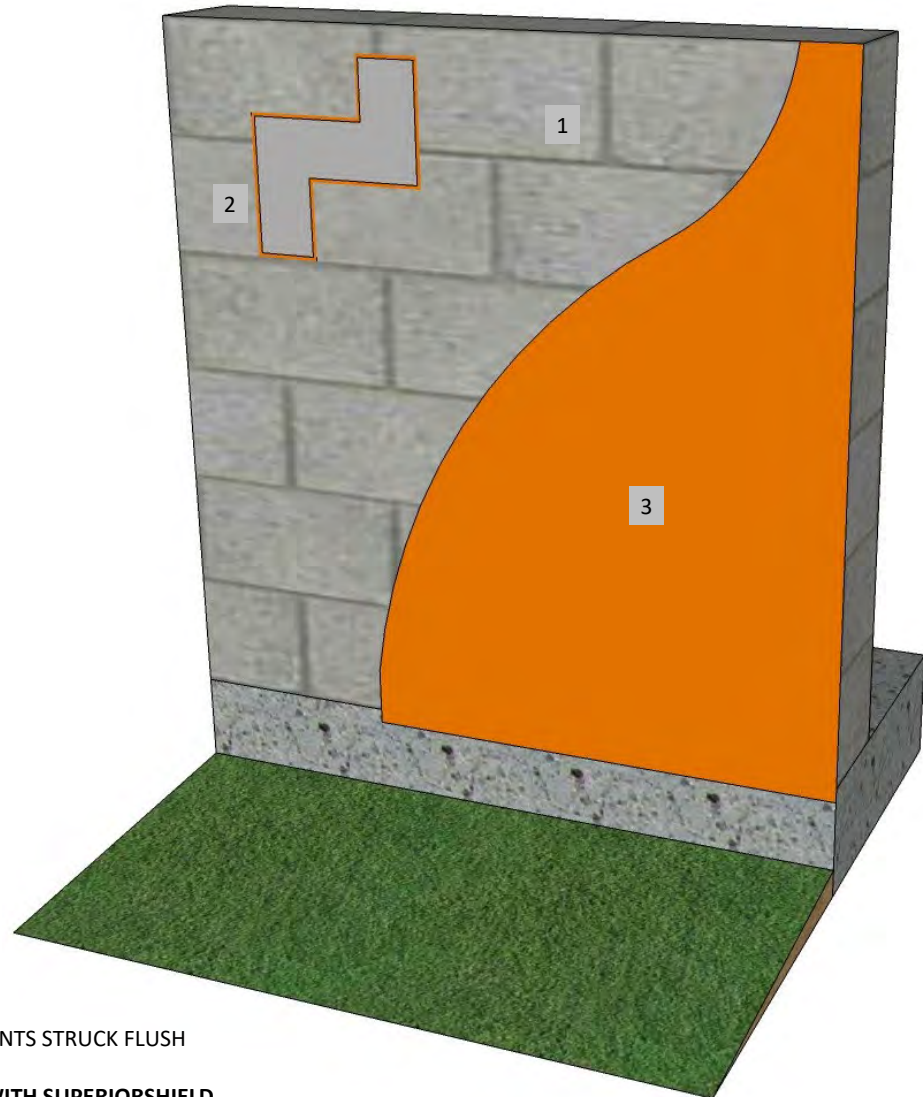

1. APPROVED SUBSTRATE, MASONRY JOINTS STRUCK FLUSH PREFERRED
2. REPAIR ANY CRACKS IN SUBSTRATE WITH SUPERIORSHIELD FLASHING TAPE SET IN WET ROLLERSHIELD (ALTERNATE SUPERIORFLASH). LAP SPLICES 2" (51 MM) MIN.
3. ROLLERSHIELD AIR/WATER BARRIER

**RSLAB-02 APPLICATION ON CMU, MASONRY OR CONCRETE**

**M Master Wall Inc.®**  
Building a Culture of Excellence

PO Box 397 · Fortson · GA · 31808 · 800-755-0825 · masterwall.com

These drawings relay the conceptual conditions of Master Wall® Systems and are not the construction drawings. Ultimately the design and detailing of an entire wall system is the responsibility of a professional. These details will guide the design professional in the use of Master Wall® Products. Master Wall disclaims design, warranty or construction intent or responsibility. Bold or Brand Name = Master Wall® Product. ©2025 Master Wall Inc.®



**Master Wall Inc.**  
Building a Culture of Excellence

ROLLERSHIELD LAB

SYSTEM DETAIL

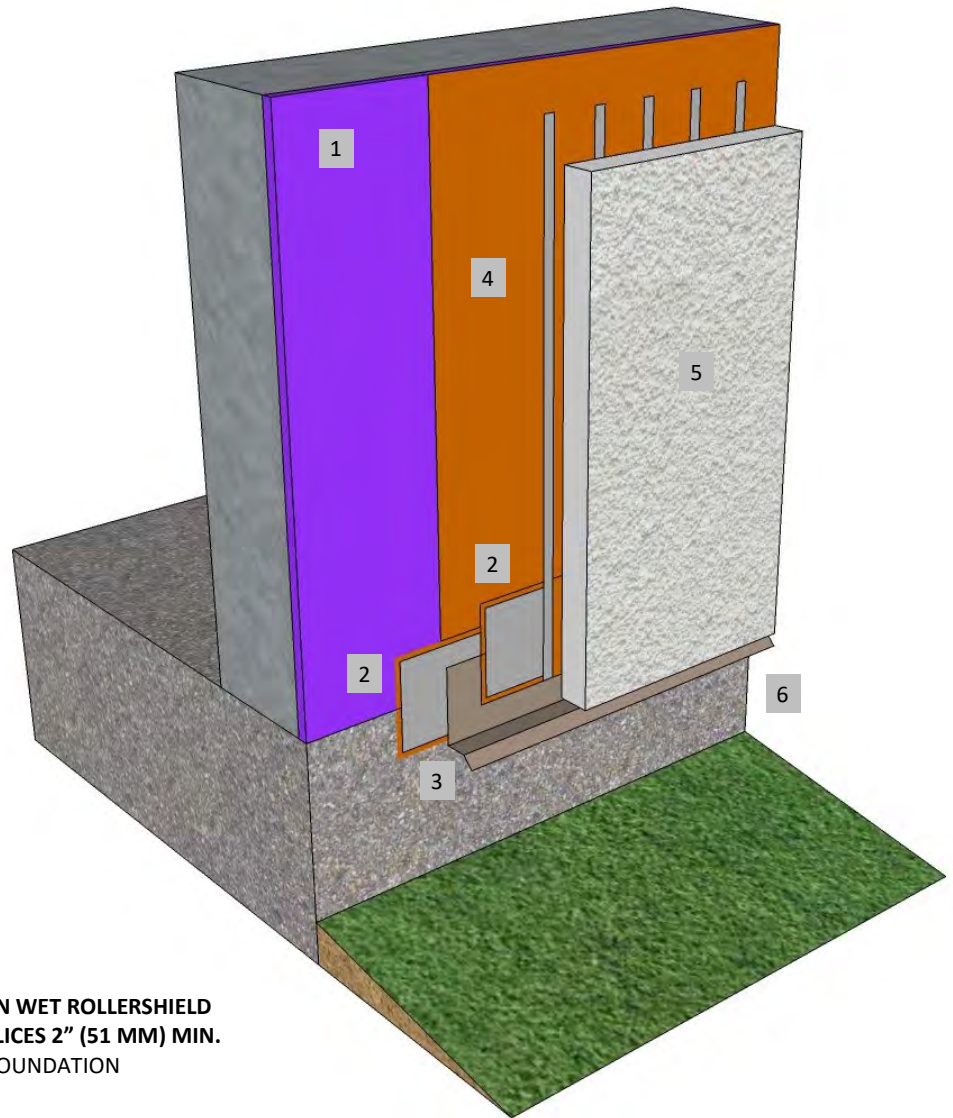

1. FRAMING & APPROVED SUBSTRATE
2. SUPERIORSHIELD FLASHING TAPE SET IN WET ROLLERSHIELD (ALTERNATE SUPERIORFLASH). LAP SPLICES 2" (51 MM) MIN.
3. FLASHING SET 1" (25 MM) MIN. OVER FOUNDATION
4. ROLLERSHIELD AIR/WATER BARRIER
5. ROLLERSHIELD DRAINAGE CIFS®
6. KEEP SYSTEM 6" (152 MM) MIN. ABOVE GRADE

**RSLAB-03 CIFS® OR EIFS TERMINATION**

**M Master Wall Inc.**  
Building a Culture of Excellence

PO Box 397 · Fortson · GA · 31808 · 800-755-0825 · masterwall.com

These drawings relay the conceptual conditions of Master Wall® Systems and are not the construction drawings. Ultimately the design and detailing of an entire wall system is the responsibility of a professional. These details will guide the design professional in the use of Master Wall® Products. Master Wall disclaims design, warranty or construction intent or responsibility. Bold or Brand Name = Master Wall® Product. ©2025 Master Wall Inc.®



**Master Wall Inc.**  
Building a Culture of Excellence

ROLLERSHIELD LAB

SYSTEM DETAIL

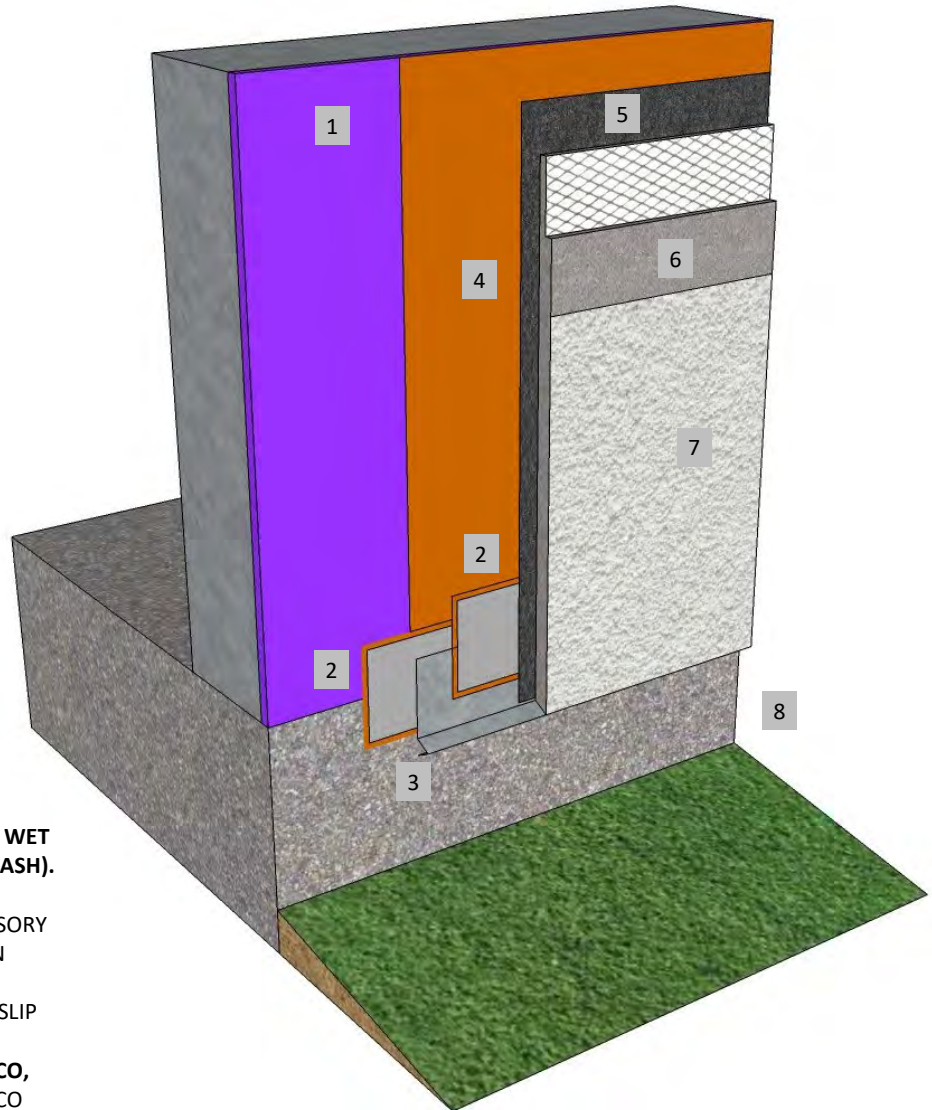

1. FRAMING & APPROVED SUBSTRATE
2. SUPERIORSHIELD FLASHING TAPE SET IN WET ROLLERSHIELD (ALTERNATE SUPERIORFLASH), LAP SPLICES 2" (51 MM) MIN.
3. STUCCO WEEP SCREED OR OTHER ACCESSORY SET 1" (25 MM) MIN. OVER FOUNDATION
4. ROLLERSHIELD AIR/WATER BARRIER
5. SECONDARY WATER RESISTIVE BARRIER, SLIP SHEET OR DRAINAGE MAT
6. MASTER WALL CEMPLASTER FIBERSTUCCO, ONE COAT STUCCO OR ASTM C926 STUCCO
7. MASTER WALL SUPERIOR FINISH
8. KEEP SYSTEM 6" (152 MM) MIN. ABOVE GRADE

### RSLAB-04 STUCCO TERMINATION AT FOUNDATION

**M Master Wall Inc.**  
Building a Culture of Excellence

PO Box 397 · Fortson · GA · 31808 · 800-755-0825 · masterwall.com

These drawings relay the conceptual conditions of Master Wall® Systems and are not the construction drawings. Ultimately the design and detailing of an entire wall system is the responsibility of a professional. These details will guide the design professional in the use of Master Wall® Products. Master Wall disclaims design, warranty or construction intent or responsibility. Bold or Brand Name = Master Wall® Product. ©2025 Master Wall Inc.®



**Master Wall Inc.**  
Building a Culture of Excellence

ROLLERSHIELD LAB

SYSTEM DETAIL

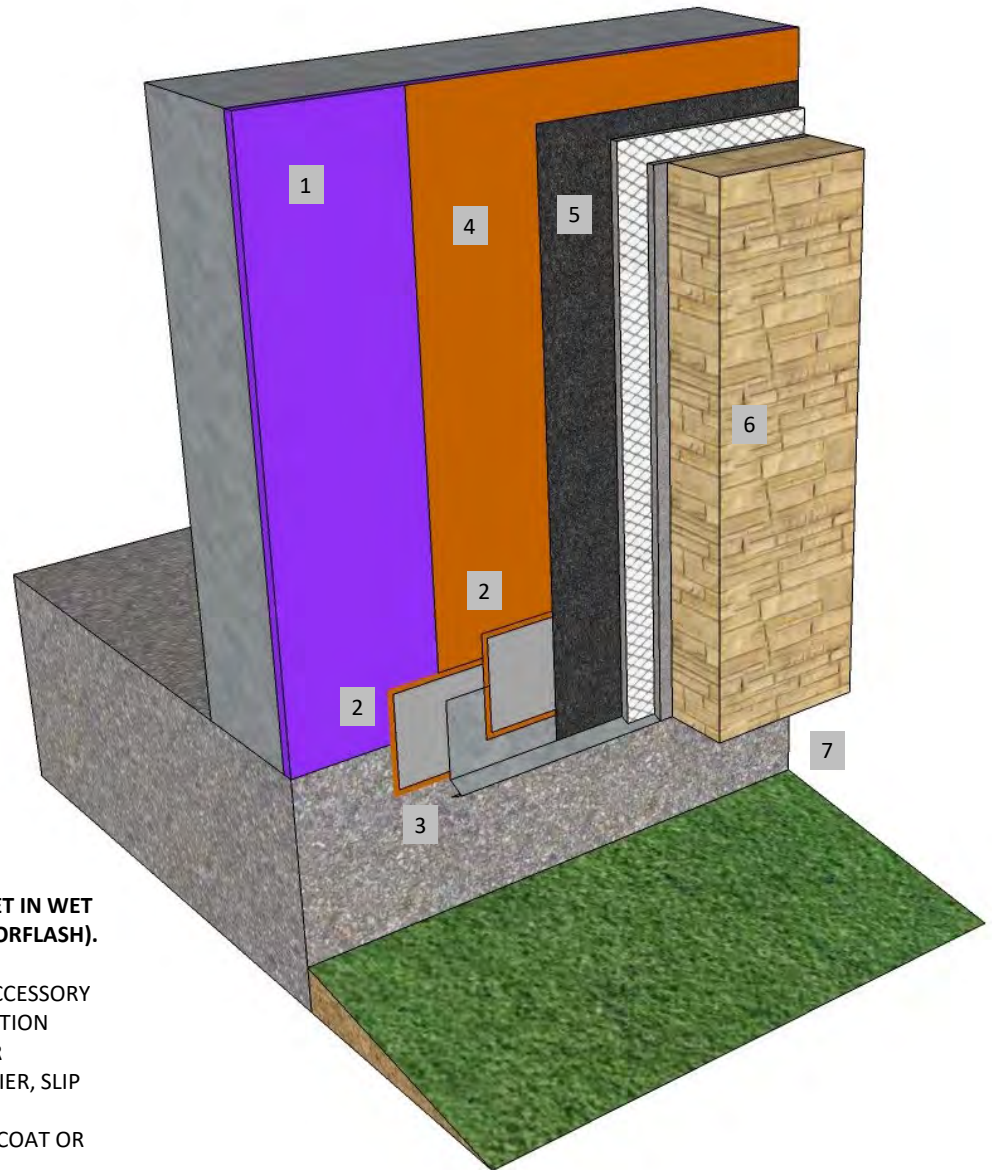

1. FRAMING & APPROVED SUBSTRATE
2. **SUPERIORSHIELD FLASHING TAPE SET IN WET ROLLERSHIELD (ALTERNATE SUPERIORFLASH). LAP SPLICES 2" (51 MM) MIN.**
3. STUCCO WEEP SCREED OR OTHER ACCESSORY SET 1" (25 MM) MIN. OVER FOUNDATION
4. **ROLLERSHIELD AIR/WATER BARRIER**
5. SECONDARY WATER RESISTIVE BARRIER, SLIP SHEET OR DRAINAGE MAT
6. THIN BRICK OR STONE ON SCRATCH COAT OR OTHER APPLICATION
7. KEEP SYSTEM 6" (152 MM) MIN. ABOVE GRADE

**RSLAB-05 STONE TERMINATION AT FOUNDATION**

**M Master Wall Inc.**  
Building a Culture of Excellence

PO Box 397 · Fortson · GA · 31808 · 800-755-0825 · masterwall.com

These drawings relay the conceptual conditions of Master Wall® Systems and are not the construction drawings. Ultimately the design and detailing of an entire wall system is the responsibility of a professional. These details will guide the design professional in the use of Master Wall® Products. Master Wall disclaims design, warranty or construction intent or responsibility. Bold or Brand Name = Master Wall® Product. ©2025 Master Wall Inc.®



**Master Wall Inc.®**  
Building a Culture of Excellence

ROLLERSHIELD LAB

SYSTEM DETAIL

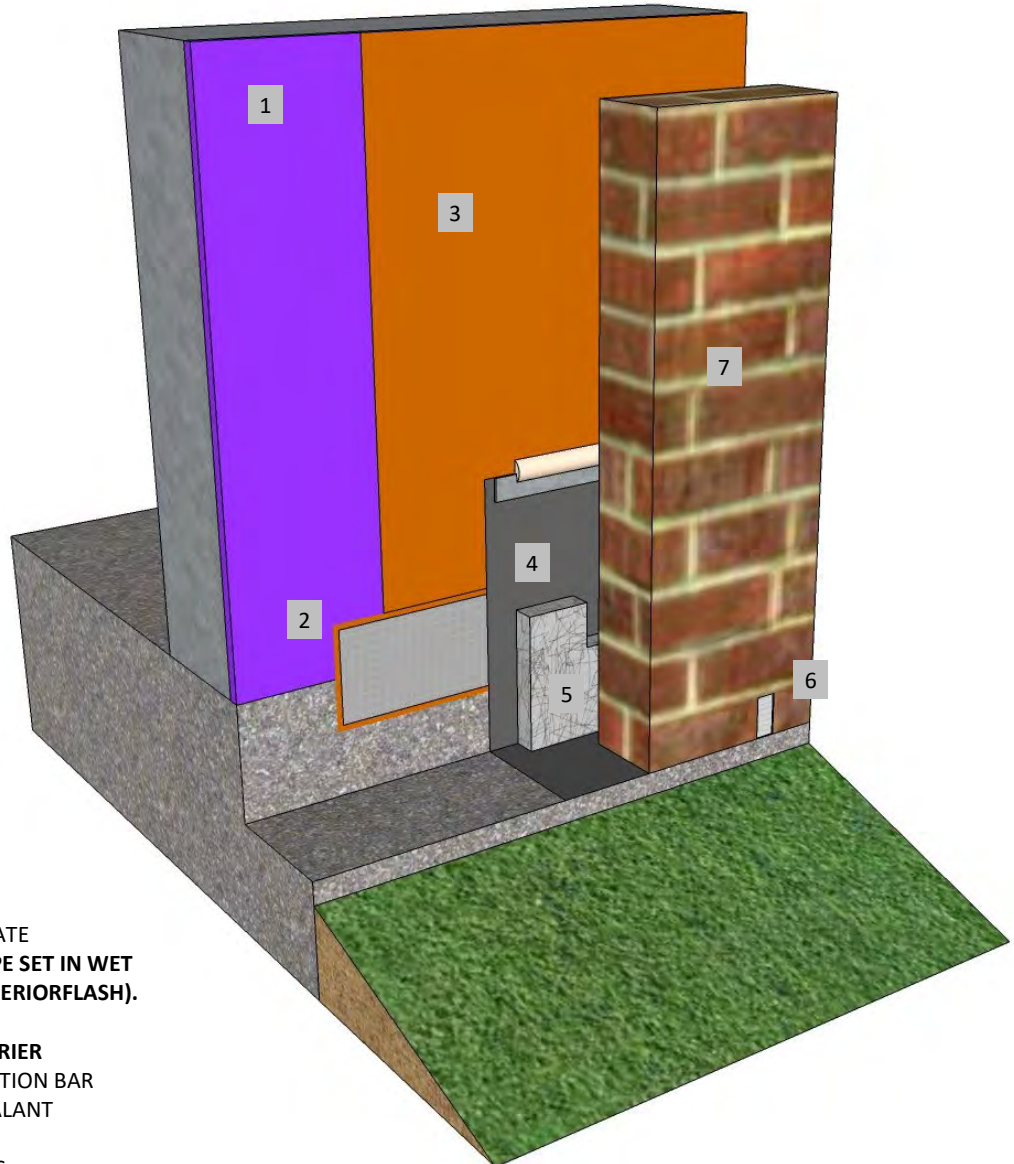

1. FRAMING & APPROVED SUBSTRATE
2. SUPERIORSHIELD FLASHING TAPE SET IN WET ROLLERSHIELD (ALTERNATE SUPERIORFLASH). LAP SPLICES 2" (51 MM) MIN.
3. ROLLERSHIELD AIR/WATER BARRIER
4. BRICK FLASHING WITH TERMINATION BAR AND COMPATIBLE EXTERIOR SEALANT
5. MORTAR PROTECTION
6. WEEP HOLES IN VERTICAL JOINTS
7. BRICK

**RSLAB-06 BRICK TERMINATION AT FOUNDATION**

**M Master Wall Inc.®**  
Building a Culture of Excellence

PO Box 397 · Fortson · GA · 31808 · 800-755-0825 · masterwall.com

These drawings relay the conceptual conditions of Master Wall® Systems and are not the construction drawings. Ultimately the design and detailing of an entire wall system is the responsibility of a professional. These details will guide the design professional in the use of Master Wall® Products. Master Wall disclaims design, warranty or construction intent or responsibility. Bold or Brand Name = Master Wall® Product. ©2025 Master Wall Inc.®



**Master Wall Inc.**  
Building a Culture of Excellence

ROLLERSHIELD LAB

SYSTEM DETAIL

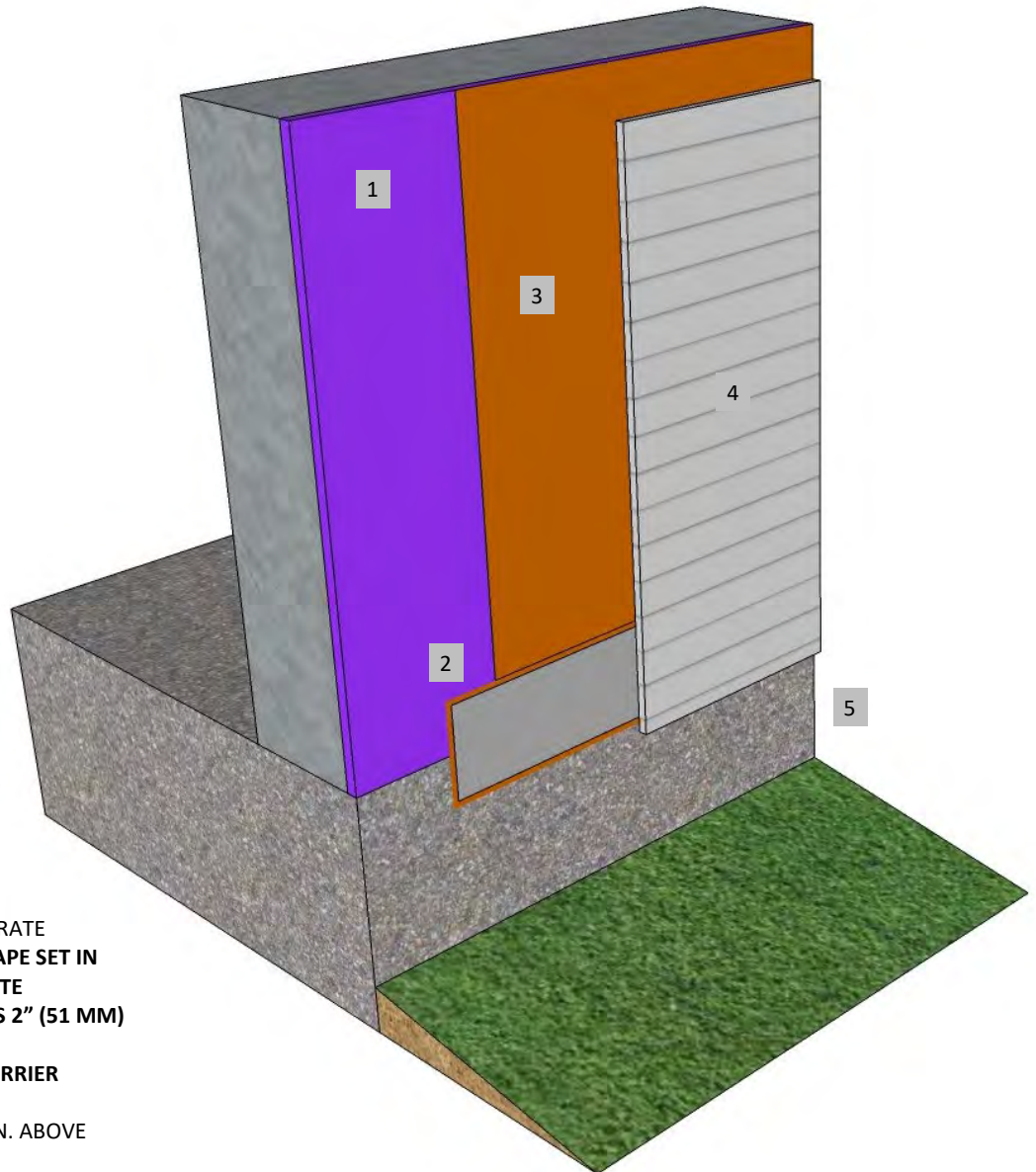

1. FRAMING & APPROVED SUBSTRATE
2. SUPERIORSHIELD FLASHING TAPE SET IN WET ROLLERSHIELD (ALTERNATE SUPERIORFLASH). LAP SPLICES 2" (51 MM) MIN.
3. ROLLERSHIELD AIR/WATER BARRIER
4. SIDING
5. KEEP SYSTEM 6" (152 MM) MIN. ABOVE GRADE

**RSLAB-07 SIDING TERMINATION AT FOUNDATION**

**M Master Wall Inc.**  
Building a Culture of Excellence

PO Box 397 · Fortson · GA · 31808 · 800-755-0825 · masterwall.com

These drawings relay the conceptual conditions of Master Wall® Systems and are not the construction drawings. Ultimately the design and detailing of an entire wall system is the responsibility of a professional. These details will guide the design professional in the use of Master Wall® Products. Master Wall disclaims design, warranty or construction intent or responsibility. Bold or Brand Name = Master Wall® Product. ©2025 Master Wall Inc.®



**Master Wall Inc.®**  
Building a Culture of Excellence

ROLLERSHIELD LAB

SYSTEM DETAIL

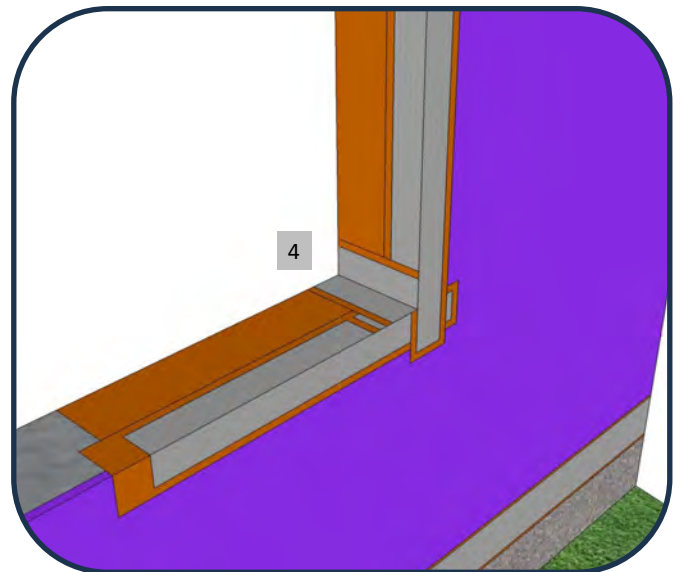
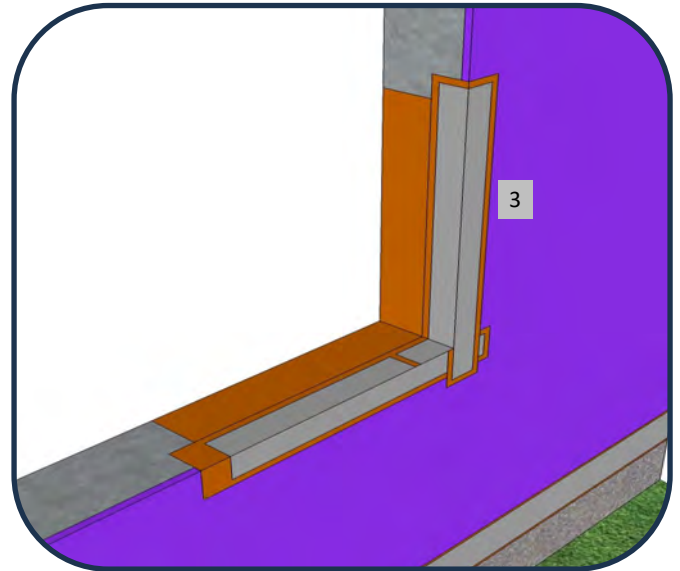
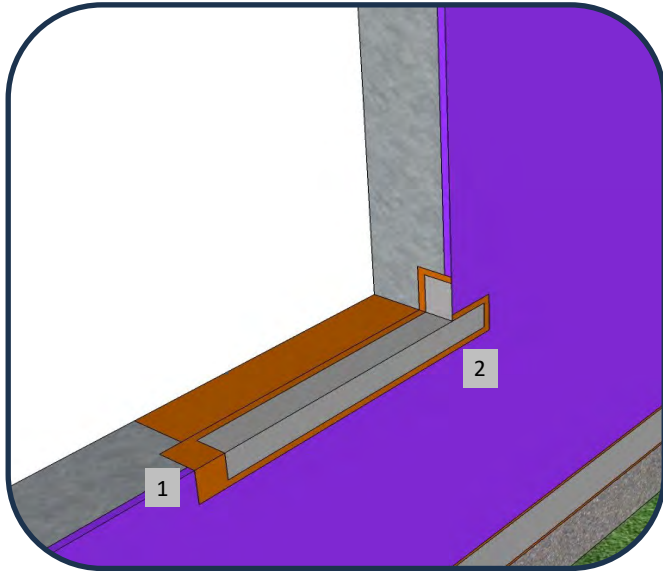

1. START AT THE BASE OF THE WINDOW. APPLY WET **ROLLERSHIELD** USING A TROWEL, BRUSH OR ROLLER TO THE SILL AND FACE OF THE WALL.
2. CENTER AND EMBED **SUPERIORSHIELD FLASHING TAPE** INTO THE WET **ROLLERSHIELD** AND EXTEND UP THE WALL 3" (75 MM) UP THE JAMBS AND ONTO THE FACE OF THE WALL. SMOOTH USING TROWEL, BRUSH OR ROLLER.
3. APPLY JAMB FLASHING IN A SIMILAR MANNER EXTENDING THE FLASHING 3" MIN. ONTO THE SILL SURFACE.
4. SEAL CORNER WITH AN ADDITIONAL STRIP OF **ROLLERSHIELD FLASHING TAPE** CENTERED IN THE CORNER
5. APPLY HEAD FLASHING IN A SIMILAR MANNER (NOT SHOWN).

### ***RSLAB-08 BASIC FLASHING – METHOD A***

**M Master Wall Inc.®**  
Building a Culture of Excellence

PO Box 397 · Fortson · GA · 31808 · 800-755-0825 · masterwall.com

These drawings relay the conceptual conditions of Master Wall® Systems and are not the construction drawings. Ultimately the design and detailing of an entire wall system is the responsibility of a professional. These details will guide the design professional in the use of Master Wall® Products. Master Wall disclaims design, warranty or construction intent or responsibility. Bold or Brand Name = Master Wall® Product. ©2025 Master Wall Inc.®



**Master Wall Inc.**  
Building a Culture of Excellence

ROLLERSHIELD LAB

SYSTEM DETAIL

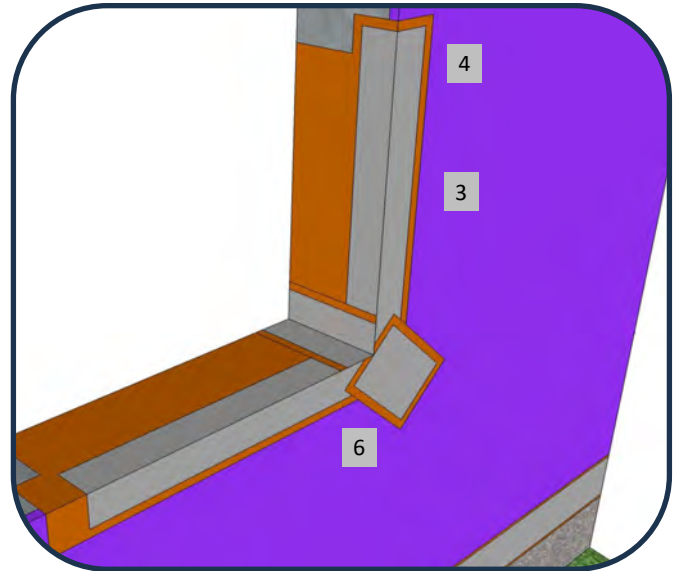
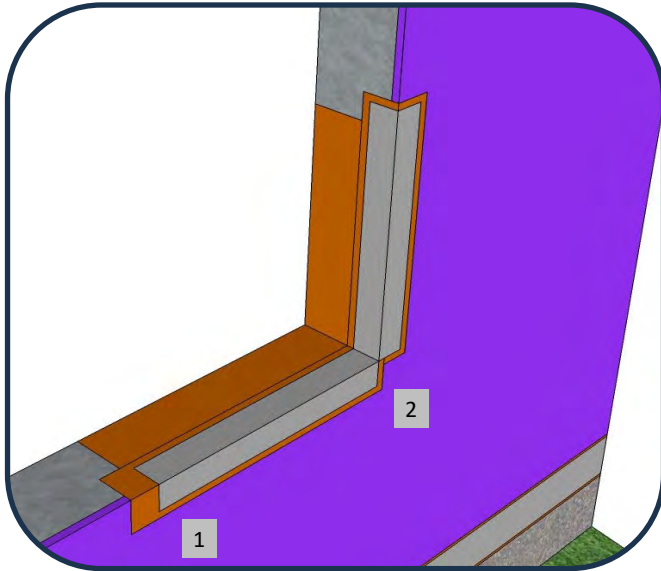

1. START AT THE BASE OF THE WINDOW. APPLY WET **ROLLERSHIELD** USING A TROWEL, BRUSH OR ROLLER TO THE SILL AND FACE OF THE WALL.
2. CENTER AND EMBED **SUPERIORSHIELD FLASHING TAPE** INTO THE WET **ROLLERSHIELD**. SMOOTH USING TROWEL, BRUSH OR ROLLER.
3. APPLY JAMB FLASHING IN A SIMILAR MANNER.
4. APPLY HEAD FLASHING IN A SIMILAR MANNER (NOT SHOWN).
5. CREATE DIAGONAL REINFORCEMENT BY CUTTING A PIECE OF **SUPERIORSHIELD FLASHING TAPE** TWICE THE DEPTH OF THE OPENING AND CAREFULLY CUT LEAVING 1-2 STRANDS
6. APPLY WET **ROLLERSHIELD** AT ALL CORNERS AND EMBED DIAGONAL REINFORCEMENT.

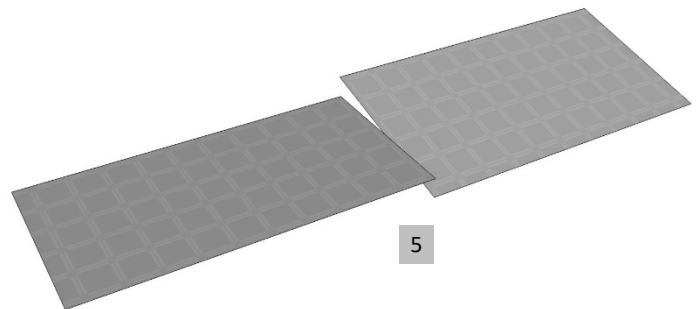

### **RSLAB-09 BASIC FLASHING – METHOD B**

**M Master Wall Inc.**  
Building a Culture of Excellence

PO Box 397 · Fortson · GA · 31808 · 800-755-0825 · masterwall.com

These drawings relay the conceptual conditions of Master Wall® Systems and are not the construction drawings. Ultimately the design and detailing of an entire wall system is the responsibility of a professional. These details will guide the design professional in the use of Master Wall® Products. Master Wall disclaims design, warranty or construction intent or responsibility. Bold or Brand Name = Master Wall® Product. ©2025 Master Wall Inc.®



**Master Wall Inc.**  
Building a Culture of Excellence

ROLLERSHIELD LAB

SYSTEM DETAIL

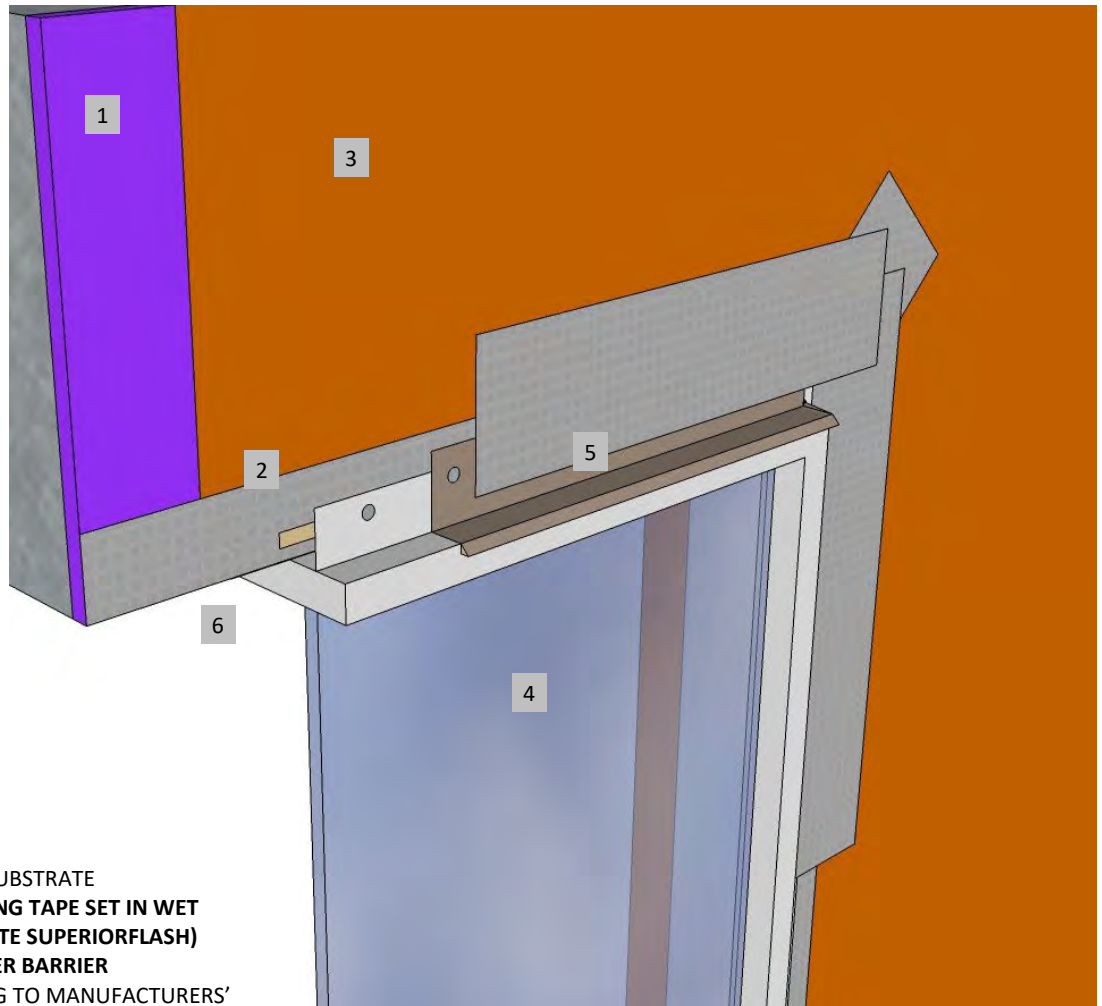

1. FRAMING & APPROVED SUBSTRATE
2. SUPERIORSHIELD FLASHING TAPE SET IN WET ROLLERSHIELD (ALTERNATE SUPERIORFLASH)
3. ROLLERSHIELD AIR/WATER BARRIER
4. WINDOW SET ACCORDING TO MANUFACTURERS' INSTRUCTIONS
5. HEAD FLASHING WITH END DAMS SHOWN, SET IN SEALANT. FLASH ONTO WINDOW FLANGE IF SELF-FLASHING WINDOW IS USED
6. INTERIOR SEALANT (NOT SHOWN)

### RSLAB-10 WINDOW HEAD DETAIL

**M Master Wall Inc.**  
Building a Culture of Excellence

PO Box 397 · Fortson · GA · 31808 · 800-755-0825 · masterwall.com

These drawings relay the conceptual conditions of Master Wall® Systems and are not the construction drawings. Ultimately the design and detailing of an entire wall system is the responsibility of a professional. These details will guide the design professional in the use of Master Wall® Products. Master Wall disclaims design, warranty or construction intent or responsibility. Bold or Brand Name = Master Wall® Product. ©2025 Master Wall Inc.®



**Master Wall Inc.®**  
Building a Culture of Excellence

ROLLERSHIELD LAB

SYSTEM DETAIL

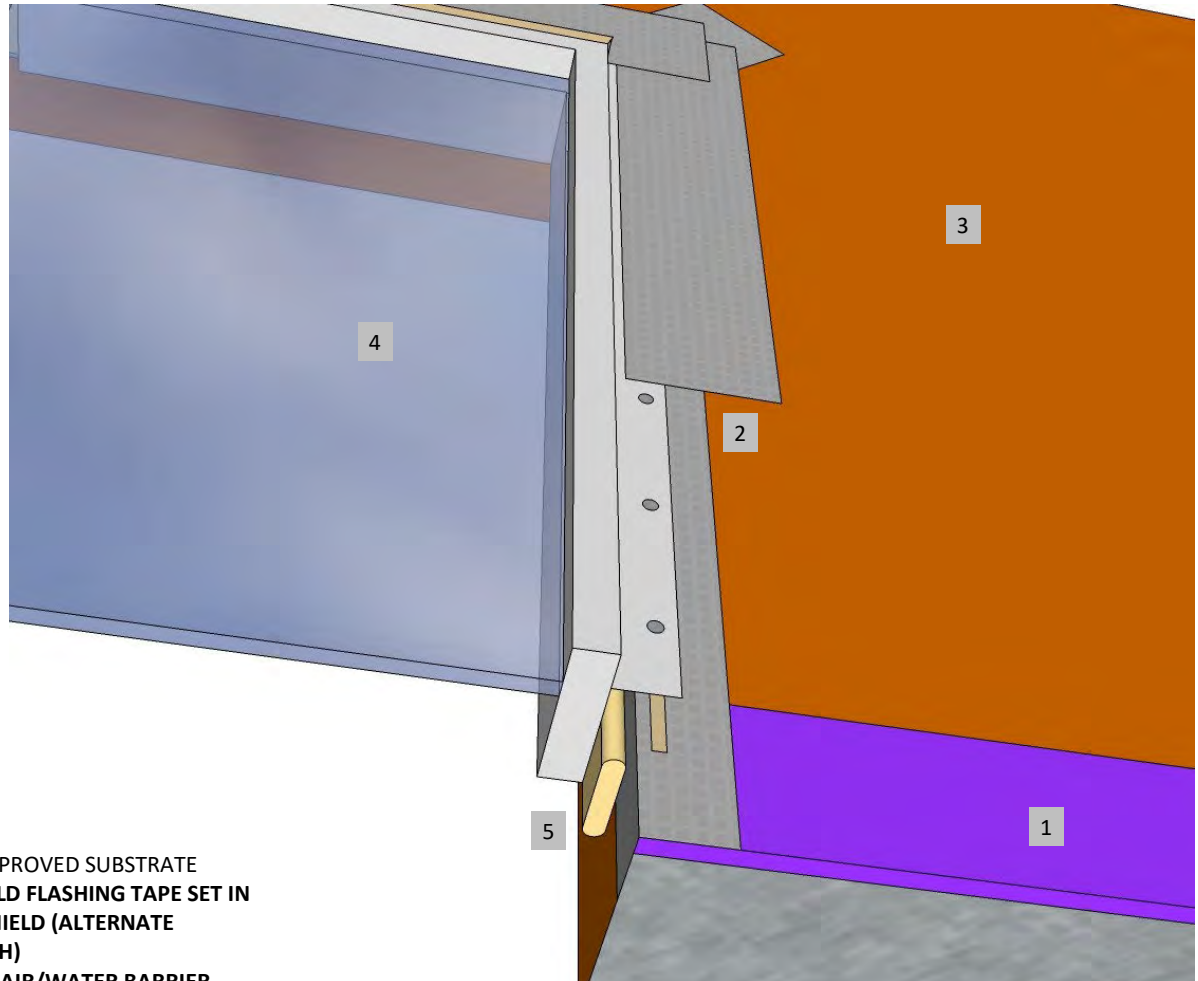

1. FRAMING & APPROVED SUBSTRATE
2. SUPERIORSHIELD FLASHING TAPE SET IN WET ROLLERSHIELD (ALTERNATE SUPERIORFLASH)
3. ROLLERSHIELD AIR/WATER BARRIER
4. WINDOW SET ACCORDING TO MANUFACTURERS' INSTRUCTIONS
5. INTERIOR SEALANT

**RSLAB-11 TYPICAL WINDOW JAMB DETAIL**

**M Master Wall Inc.®**  
Building a Culture of Excellence

PO Box 397 · Fortson · GA · 31808 · 800-755-0825 · masterwall.com

These drawings relay the conceptual conditions of Master Wall® Systems and are not the construction drawings. Ultimately the design and detailing of an entire wall system is the responsibility of a professional. These details will guide the design professional in the use of Master Wall® Products. Master Wall disclaims design, warranty or construction intent or responsibility. Bold or Brand Name = Master Wall® Product. ©2025 Master Wall Inc.®



**Master Wall Inc.**  
Building a Culture of Excellence

ROLLERSHIELD LAB

SYSTEM DETAIL

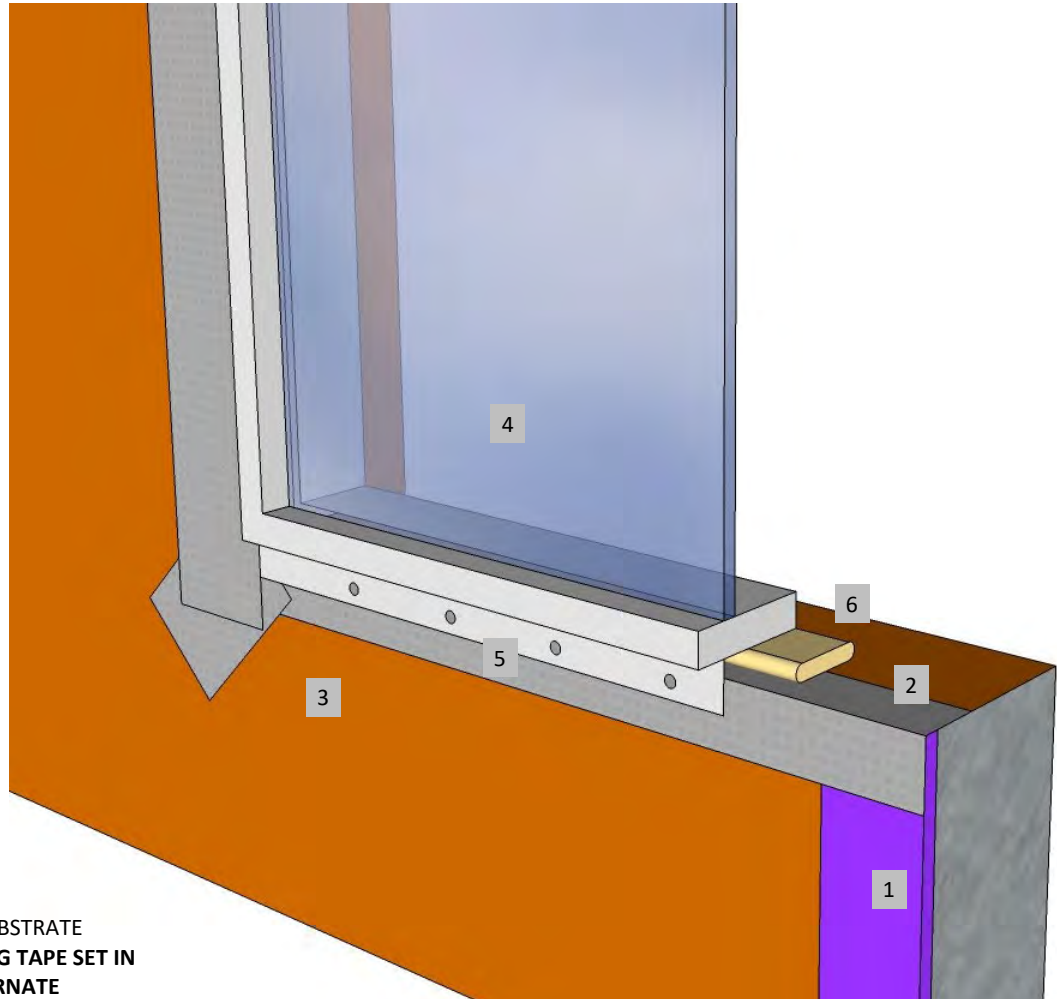

1. FRAMING & APPROVED SUBSTRATE
2. SUPERIORSHIELD FLASHING TAPE SET IN WET ROLLERSHIELD (ALTERNATE SUPERIORFLASH)
3. ROLLERSHIELD AIR/WATER BARRIER
4. WINDOW SET ACCORDING TO MANUFACTURERS' INSTRUCTIONS
5. LOWER FLANGE SHOWN OPEN FOR DRAINAGE, VERIFY WITH WINDOW MANUFACTURER
6. INTERIOR SEALANT

**RSLAB-12 TYPICAL WINDOW SILL DETAIL**

**M Master Wall Inc.**  
Building a Culture of Excellence

PO Box 397 · Fortson · GA · 31808 · 800-755-0825 · masterwall.com

These drawings relay the conceptual conditions of Master Wall® Systems and are not the construction drawings. Ultimately the design and detailing of an entire wall system is the responsibility of a professional. These details will guide the design professional in the use of Master Wall® Products. Master Wall disclaims design, warranty or construction intent or responsibility. Bold or Brand Name = Master Wall® Product. ©2025 Master Wall Inc.®



**Master Wall Inc.**  
Building a Culture of Excellence

ROLLERSHIELD LAB

SYSTEM DETAIL

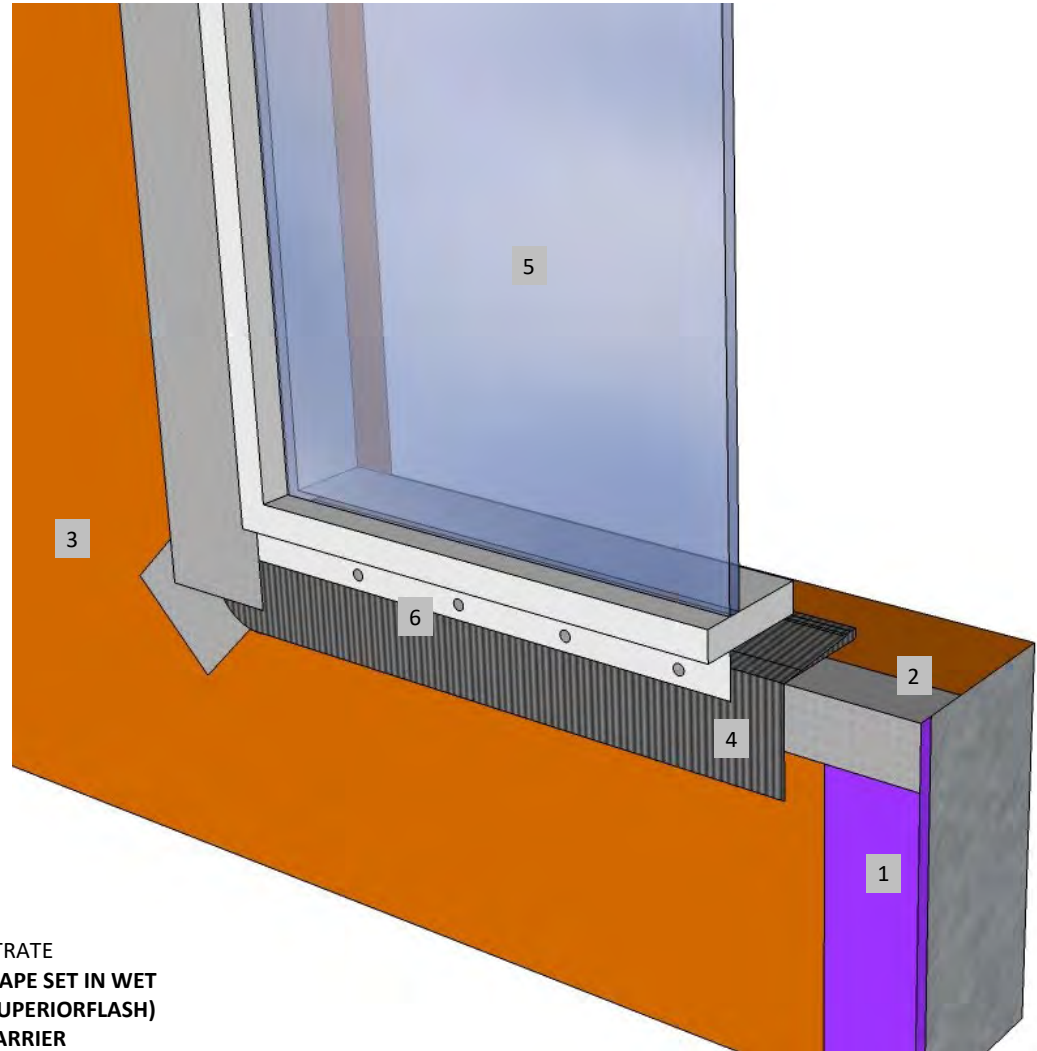

1. FRAMING & APPROVED SUBSTRATE
2. SUPERIORSHIELD FLASHING TAPE SET IN WET ROLLERSHIELD (ALTERNATE SUPERIORFLASH)
3. ROLLERSHIELD AIR/WATER BARRIER
4. SILLDRY® SILL PAN SET TO MANUFACTURER'S INSTRUCTIONS, FLASHED WITH ROLLERSHIELD AND SUPERIORSHIELD FLASHING TAPE
5. WINDOW SET ACCORDING TO MANUFACTURERS' INSTRUCTIONS
6. LOWER FLANGE SHOWN OPEN FOR DRAINAGE, VERIFY WITH WINDOW MANUFACTURER

**RSLAB-13 SILLDRY® WINDOW SILL**

**M Master Wall Inc.**  
Building a Culture of Excellence

PO Box 397 · Fortson · GA · 31808 · 800-755-0825 · masterwall.com

These drawings relay the conceptual conditions of Master Wall® Systems and are not the construction drawings. Ultimately the design and detailing of an entire wall system is the responsibility of a professional. These details will guide the design professional in the use of Master Wall® Products. Master Wall disclaims design, warranty or construction intent or responsibility. Bold or Brand Name = Master Wall® Product. ©2025 Master Wall Inc.®



**Master Wall Inc.®**  
Building a Culture of Excellence

ROLLERSHIELD LAB

SYSTEM DETAIL

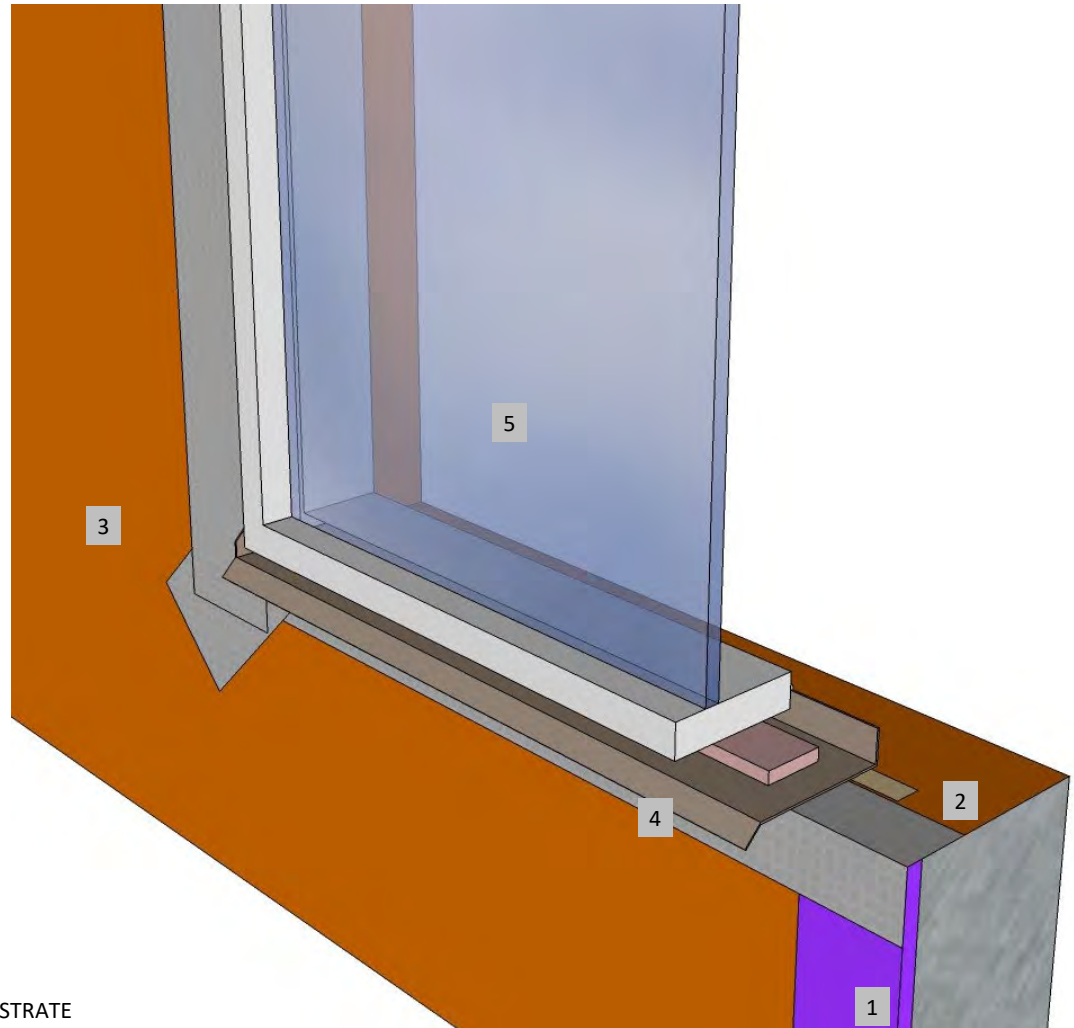

1. FRAMING & APPROVED SUBSTRATE
2. SUPERIORSHIELD FLASHING TAPE SET IN WET ROLLERSHIELD (ALTERNATE SUPERIORFLASH)
3. ROLLERSHIELD AIR/WATER BARRIER
4. SILL PAN WITH END DAMS, SET IN SEALANT
5. WINDOW SET ACCORDING TO MANUFACTURERS' INSTRUCTIONS

**RSLAB-14 TYPICAL WINDOW SILL PAN**

**M Master Wall Inc.®**  
Building a Culture of Excellence

PO Box 397 · Fortson · GA · 31808 · 800-755-0825 · masterwall.com

These drawings relay the conceptual conditions of Master Wall® Systems and are not the construction drawings. Ultimately the design and detailing of an entire wall system is the responsibility of a professional. These details will guide the design professional in the use of Master Wall® Products. Master Wall disclaims design, warranty or construction intent or responsibility. Bold or Brand Name = Master Wall® Product. ©2025 Master Wall Inc.®



**Master Wall Inc.®**  
Building a Culture of Excellence

ROLLERSHIELD LAB

SYSTEM DETAIL

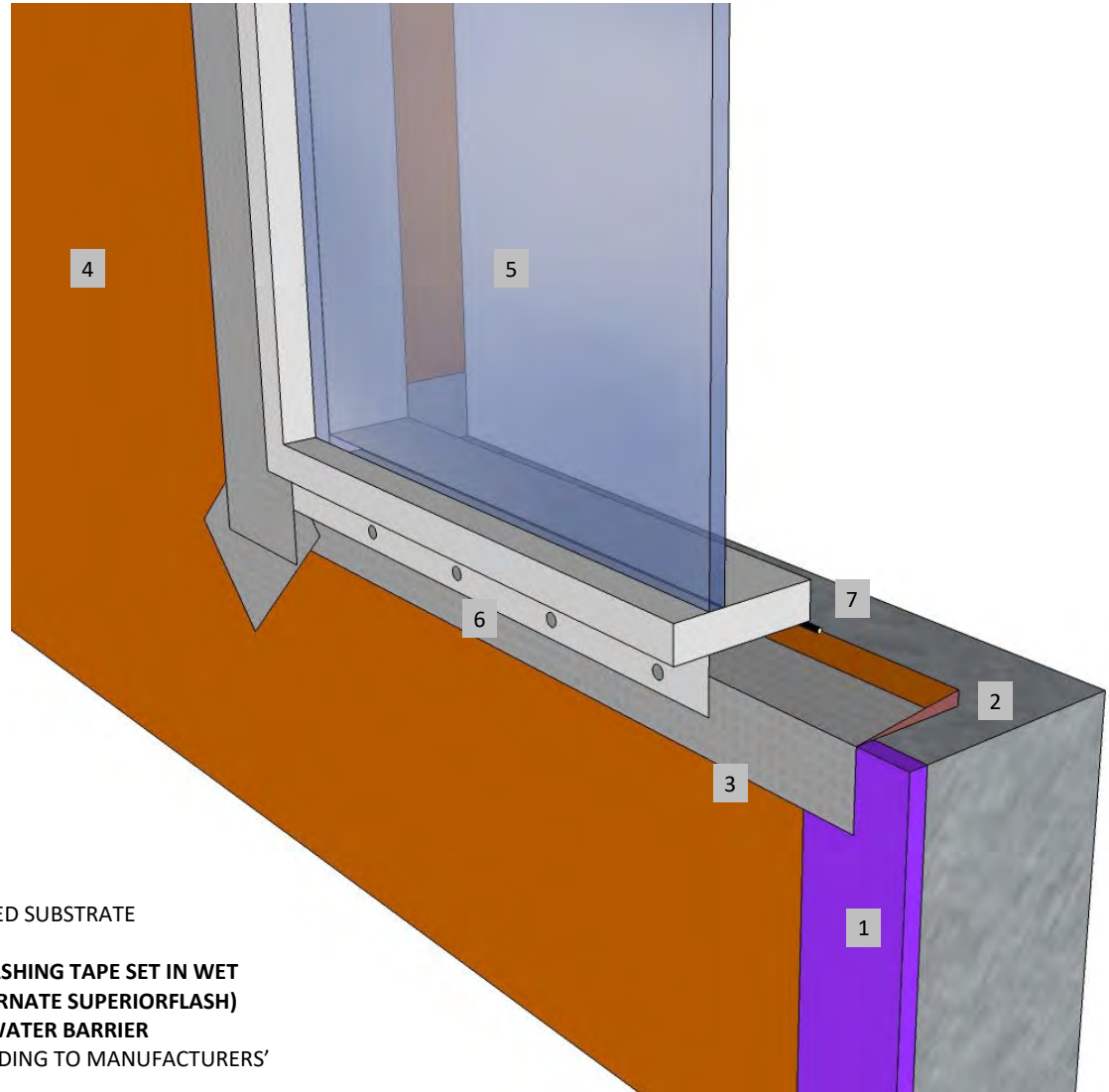

1. FRAMING & APPROVED SUBSTRATE
2. SILL WEDGE
3. SUPERIORSHIELD FLASHING TAPE SET IN WET ROLLERSHIELD (ALTERNATE SUPERIORFLASH)
4. ROLLERSHIELD AIR/WATER BARRIER
5. WINDOW SET ACCORDING TO MANUFACTURERS' INSTRUCTIONS
6. LOWER FLANGE SHOWN OPEN FOR DRAINAGE, VERIFY WITH WINDOW MANUFACTURER
7. INTERIOR SEALANT

### **RSLAB-15 TYPICAL WINDOW SILL WEDGE**

**M Master Wall Inc.®**  
Building a Culture of Excellence

PO Box 397 · Fortson · GA · 31808 · 800-755-0825 · masterwall.com

These drawings relay the conceptual conditions of Master Wall® Systems and are not the construction drawings. Ultimately the design and detailing of an entire wall system is the responsibility of a professional. These details will guide the design professional in the use of Master Wall® Products. Master Wall disclaims design, warranty or construction intent or responsibility. Bold or Brand Name = Master Wall® Product. ©2025 Master Wall Inc.®



**Master Wall Inc.**  
Building a Culture of Excellence

ROLLERSHIELD LAB

SYSTEM DETAIL

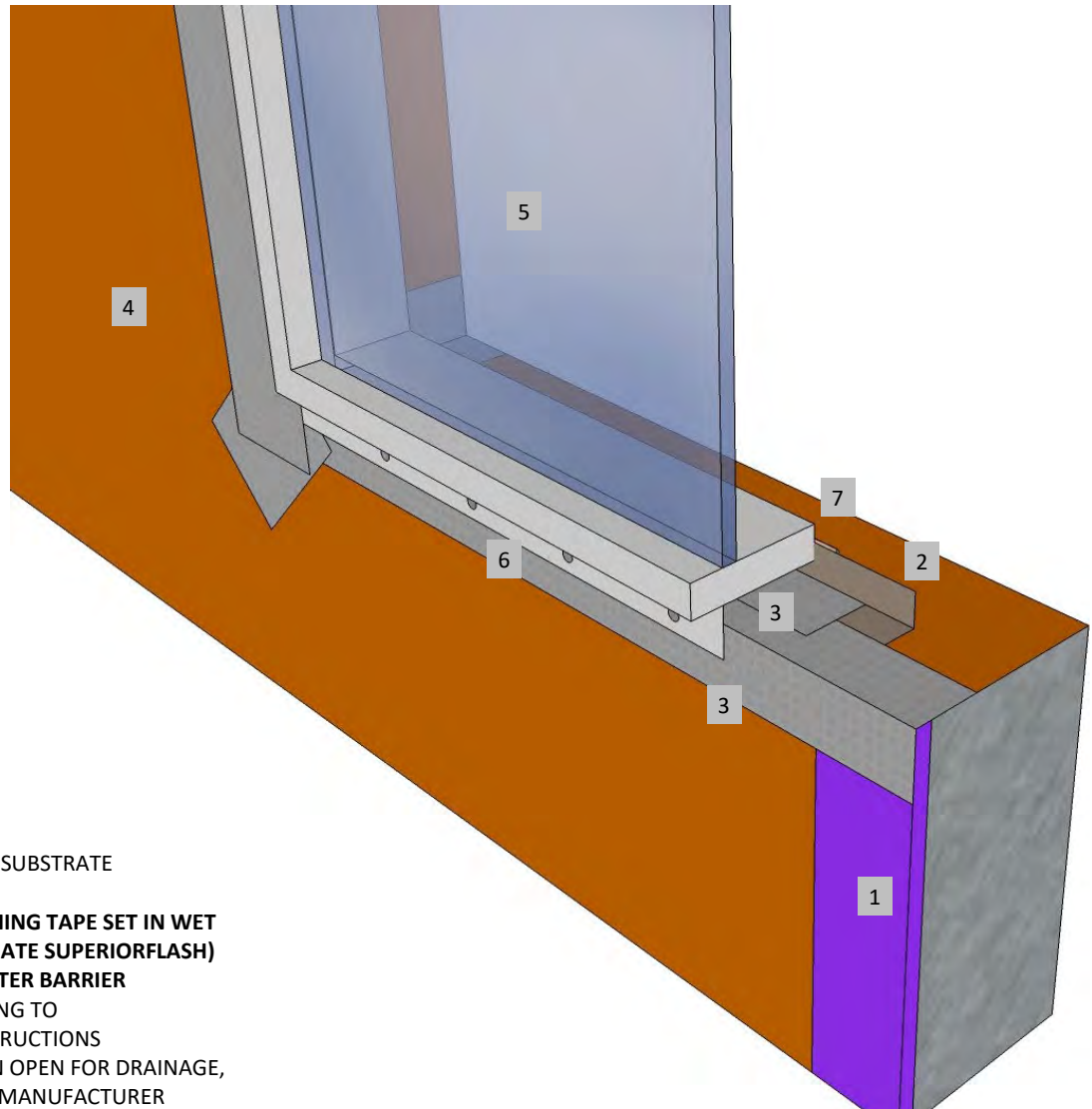

1. FRAMING & APPROVED SUBSTRATE
2. SILL STOP
3. SUPERIORSHIELD FLASHING TAPE SET IN WET ROLLERSHIELD (ALTERNATE SUPERIORFLASH)
4. ROLLERSHIELD AIR/WATER BARRIER
5. WINDOW SET ACCORDING TO MANUFACTURERS' INSTRUCTIONS
6. LOWER FLANGE SHOWN OPEN FOR DRAINAGE, VERIFY WITH WINDOW MANUFACTURER
7. INTERIOR SEALANT

**RSLAB-16 TYPICAL WINDOW SILL STOP**

**M Master Wall Inc.**  
Building a Culture of Excellence

PO Box 397 · Fortson · GA · 31808 · 800-755-0825 · masterwall.com

These drawings relay the conceptual conditions of Master Wall® Systems and are not the construction drawings. Ultimately the design and detailing of an entire wall system is the responsibility of a professional. These details will guide the design professional in the use of Master Wall® Products. Master Wall disclaims design, warranty or construction intent or responsibility. Bold or Brand Name = Master Wall® Product. ©2025 Master Wall Inc.®



**Master Wall Inc.®**  
Building a Culture of Excellence

ROLLERSHIELD LAB

SYSTEM DETAIL

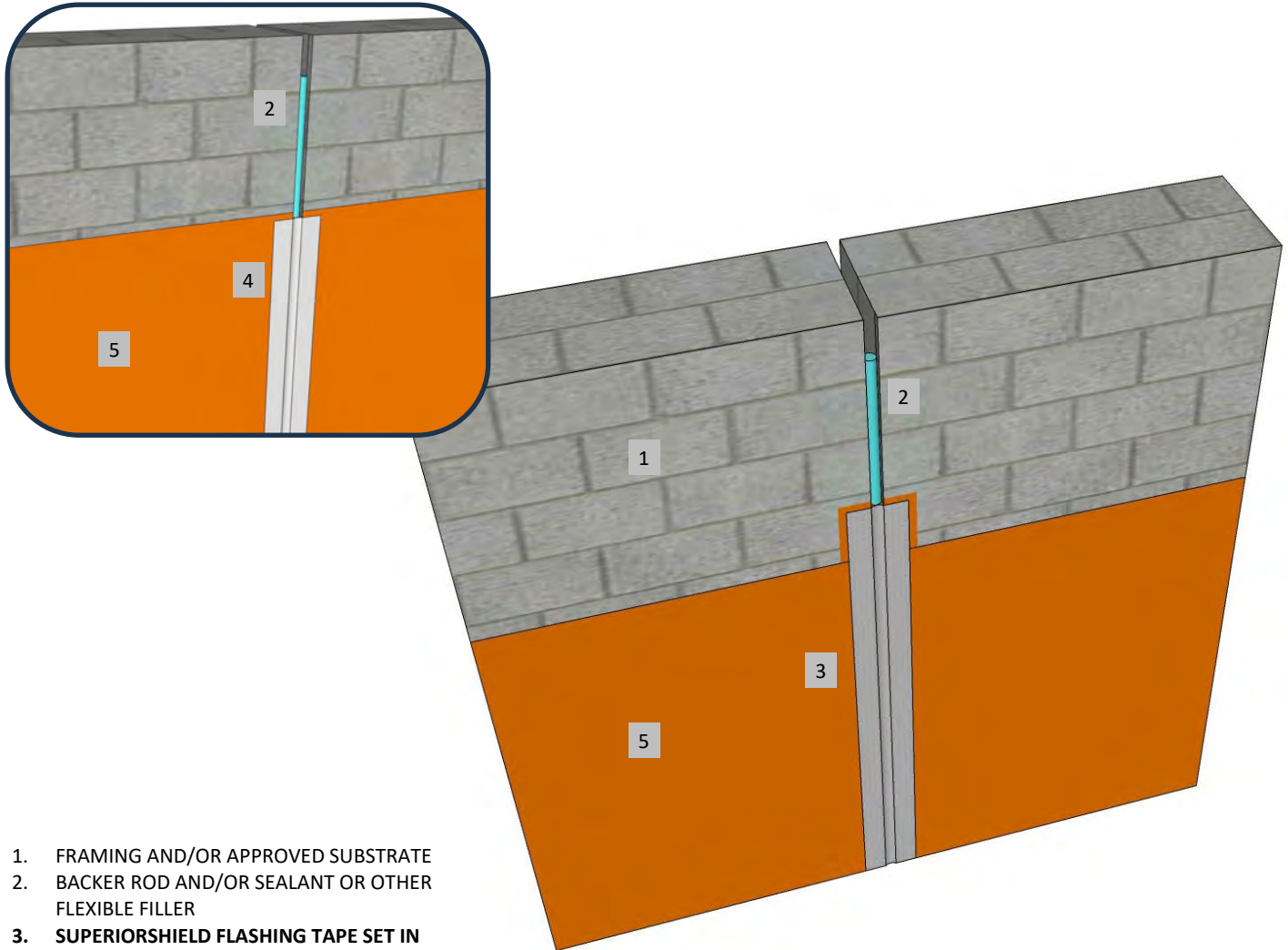

1. FRAMING AND/OR APPROVED SUBSTRATE
2. BACKER ROD AND/OR SEALANT OR OTHER FLEXIBLE FILLER
3. SUPERIORSHIELD FLASHING TAPE SET IN WET ROLLERSHIELD AND TOP COATED WITH ROLLERSHIELD (ALTERNATE SUPERIORFLASH)
4. SUPERIORSHIELD WEATHERSTOP TAPE OPTION
5. ROLLERSHIELD AIR/WATER BARRIER

**RSLAB-17 TYPICAL BUILDING EXPANSION OR CONTROL JOINT**

**M Master Wall Inc.®**  
Building a Culture of Excellence

PO Box 397 · Fortson · GA · 31808 · 800-755-0825 · masterwall.com

These drawings relay the conceptual conditions of Master Wall® Systems and are not the construction drawings. Ultimately the design and detailing of an entire wall system is the responsibility of a professional. These details will guide the design professional in the use of Master Wall® Products. Master Wall disclaims design, warranty or construction intent or responsibility. Bold or Brand Name = Master Wall® Product. ©2025 Master Wall Inc.®



**Master Wall Inc.**  
Building a Culture of Excellence

ROLLERSHIELD LAB

SYSTEM DETAIL

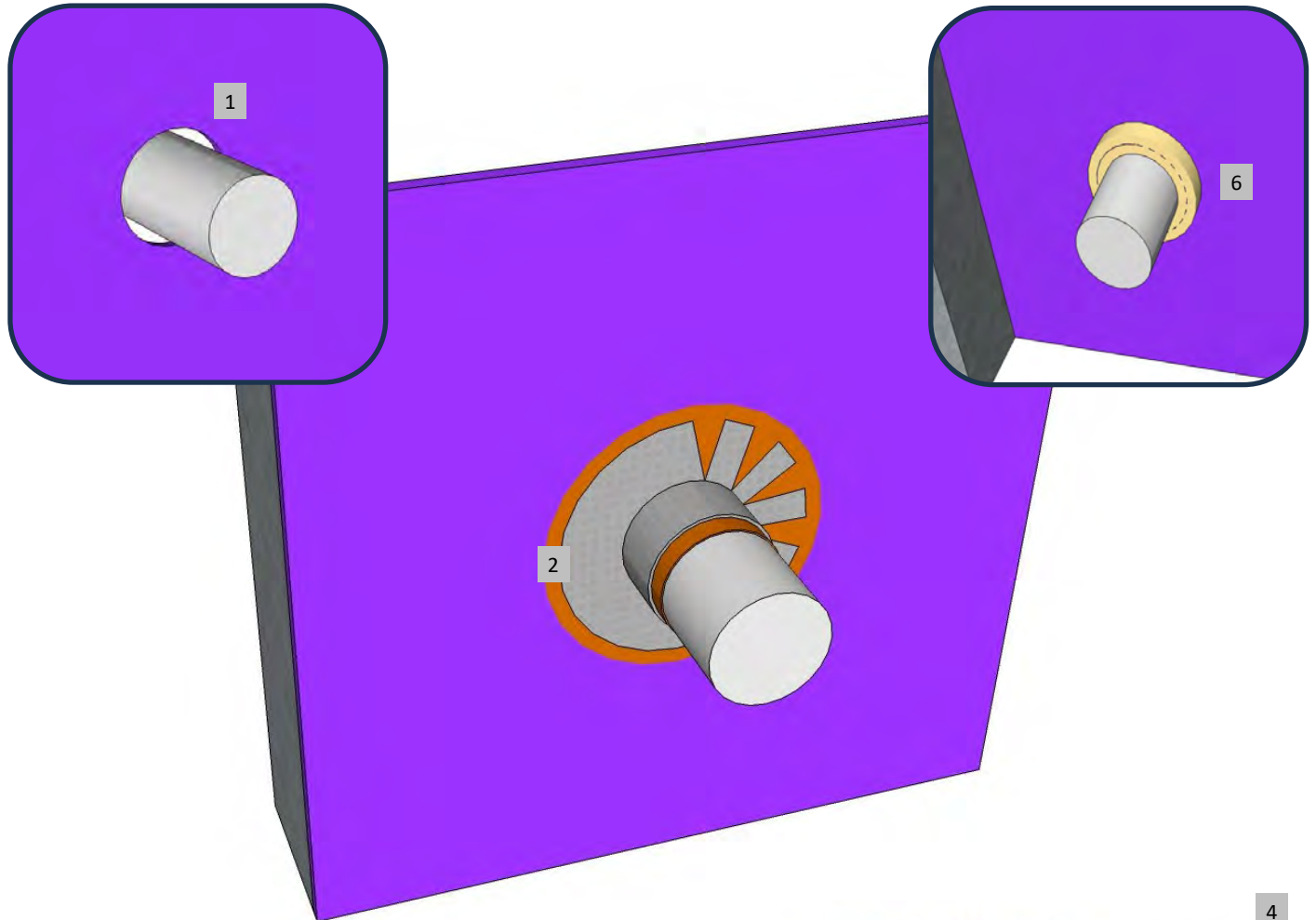

1. SECURED PIPE IN OPENING
2. SUPERIORSHIELD FLASHING TAPE SET IN WET ROLLERSHIELD, TYPICALLY 6X THE PIPE DIAMETER WILL BE REQUIRED FOR PROPER EMBEDMENT (ALTERNATE SUPERIORFLASH AT THIS LOCATION)
3. ROLLERSHIELD FLASHING TAPE CUT AS SHOWN
4. PIPE SIDE OF FLASHING
5. WALL SIDE OF FLASHING
6. INTERIOR SEALANT

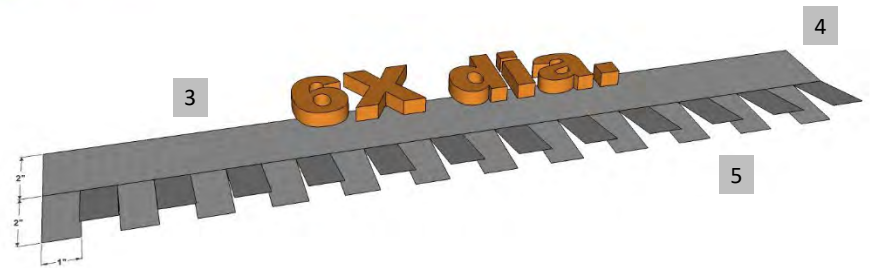

**RSLAB-18 TYPICAL PIPE PENETRATION**

**Master Wall Inc.**  
Building a Culture of Excellence

PO Box 397 · Fortson · GA · 31808 · 800-755-0825 · masterwall.com

These drawings relay the conceptual conditions of Master Wall® Systems and are not the construction drawings. Ultimately the design and detailing of an entire wall system is the responsibility of a professional. These details will guide the design professional in the use of Master Wall® Products. Master Wall disclaims design, warranty or construction intent or responsibility. Bold or Brand Name = Master Wall® Product. ©2025 Master Wall Inc.®



**Master Wall Inc.**  
Building a Culture of Excellence

ROLLERSHIELD LAB

SYSTEM DETAIL

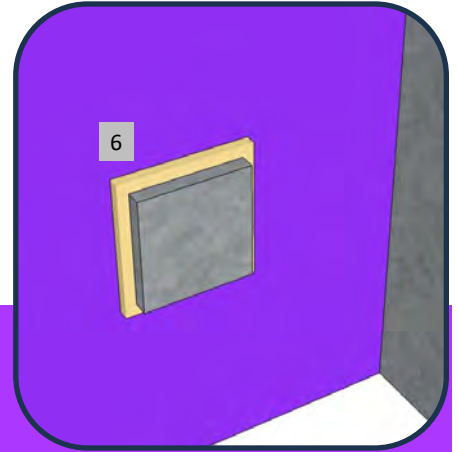
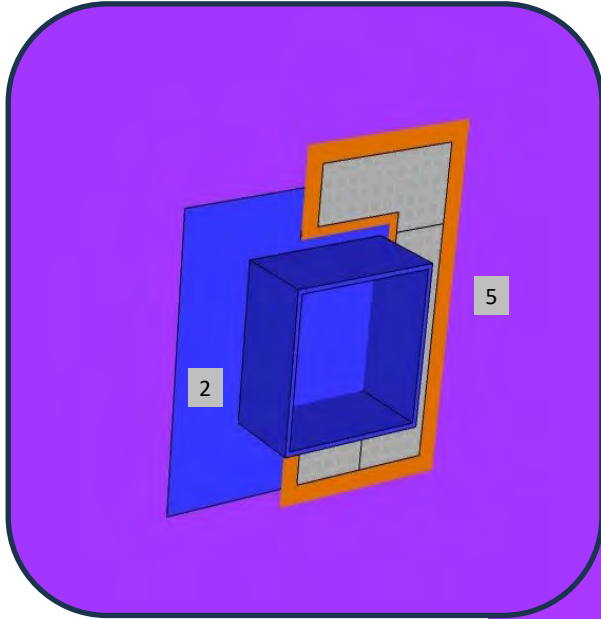

1. WATERPROOF WALL BOX
2. FLANGED WATERPROOF WALL BOX
3. FILL GAPS WITH APPROPRIATE FILLER AS NEEDED
4. ROLLERSHIELD WITH ROLLERSHIELD FLASHING TAPE FLASHED ONTO BOX WALL. CUT ROLLERSHIELD FLASHING TAPE AT LEAST 4" (102 MM) LARGER THAN BOX OPENING AND WRAP IN FOUR INDIVIDUAL PIECES
5. ROLLERSHIELD WITH ROLLERSHIELD FLASHING TAPE FLASHED ONTO BOX WALL. CUT ROLLERSHIELD FLASHING TAPE CUT STRIPS TO WRAP CONTINUOUSLY AND FILL ANY PINHOLES WITH ROLLERSHIELD (ALTERNATE SUPERIORFLASH)
6. INTERIOR SEALANT

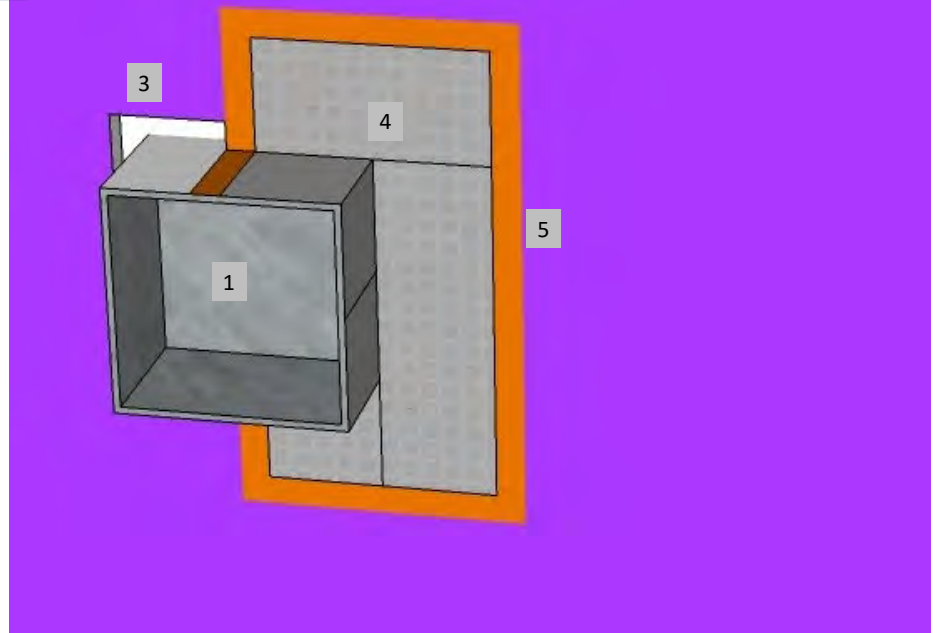

**RSLAB-19 WATERPROOF BOX**

**M Master Wall Inc.**  
Building a Culture of Excellence

PO Box 397 · Fortson · GA · 31808 · 800-755-0825 · masterwall.com

These drawings relay the conceptual conditions of Master Wall® Systems and are not the construction drawings. Ultimately the design and detailing of an entire wall system is the responsibility of a professional. These details will guide the design professional in the use of Master Wall® Products. Master Wall disclaims design, warranty or construction intent or responsibility. Bold or Brand Name = Master Wall® Product. ©2025 Master Wall Inc.®



**Master Wall Inc.**  
Building a Culture of Excellence

ROLLERSHIELD LAB

SYSTEM DETAIL

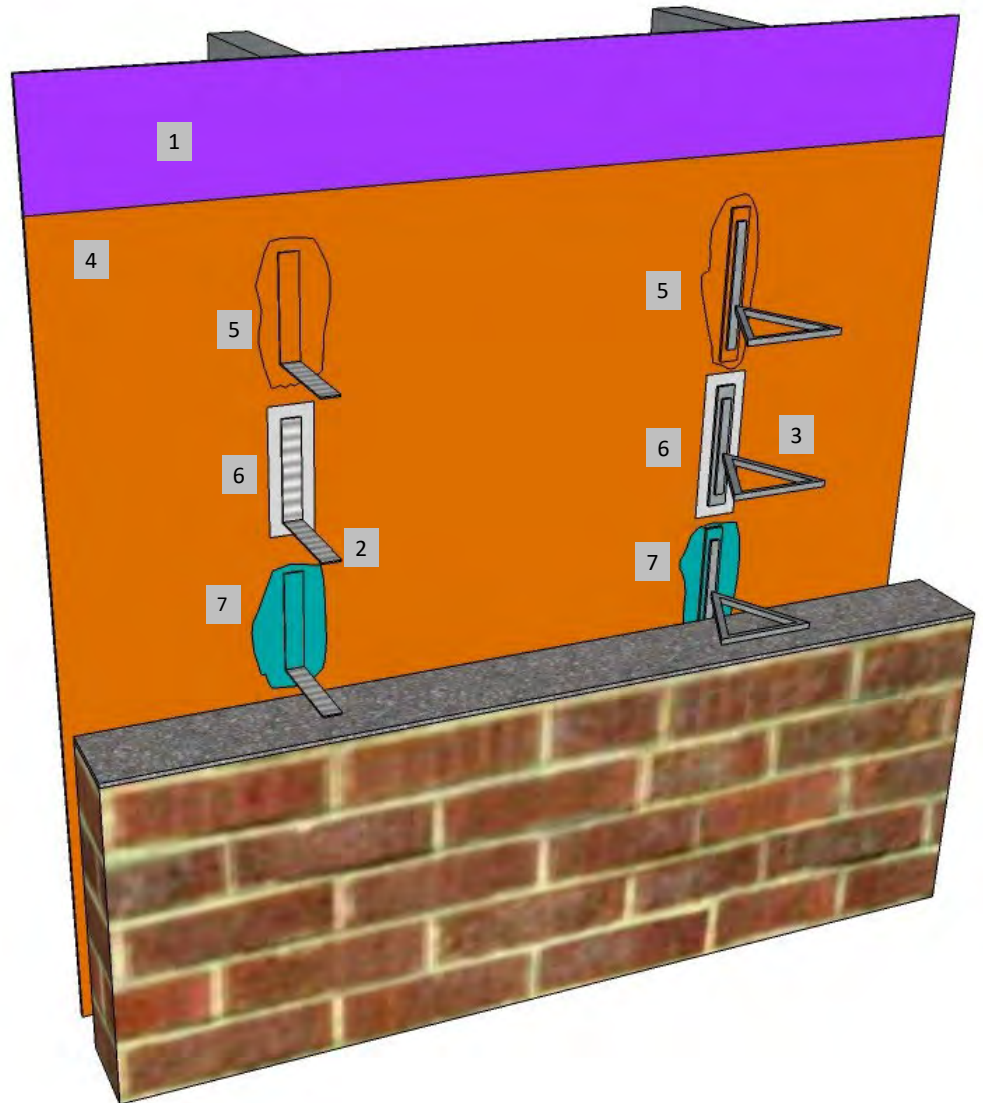

1. FRAMING & APPROVED SUBSTRATE
2. CORRUGATED BRICK TIE
3. SLIP OR INSULATED BRICK TIE
4. ROLLERSHIELD AIR/WATER BARRIER
5. SEAL WITH ROLLERSHIELD
6. SEAL WITH WEATHERSTOP TAPE OR PEEL & STICK
7. SEAL WITH SUPERIORFLASH OR SUPERIORSHIELD SMP SEALANT

**RSLAB-20 BRICK TIE**

**M Master Wall Inc.**  
Building a Culture of Excellence

PO Box 397 · Fortson · GA · 31808 · 800-755-0825 · masterwall.com

These drawings relay the conceptual conditions of Master Wall® Systems and are not the construction drawings. Ultimately the design and detailing of an entire wall system is the responsibility of a professional. These details will guide the design professional in the use of Master Wall® Products. Master Wall disclaims design, warranty or construction intent or responsibility. Bold or Brand Name = Master Wall® Product. ©2025 Master Wall Inc.®



**Master Wall Inc.®**  
Building a Culture of Excellence

ROLLERSHIELD LAB

SYSTEM DETAIL

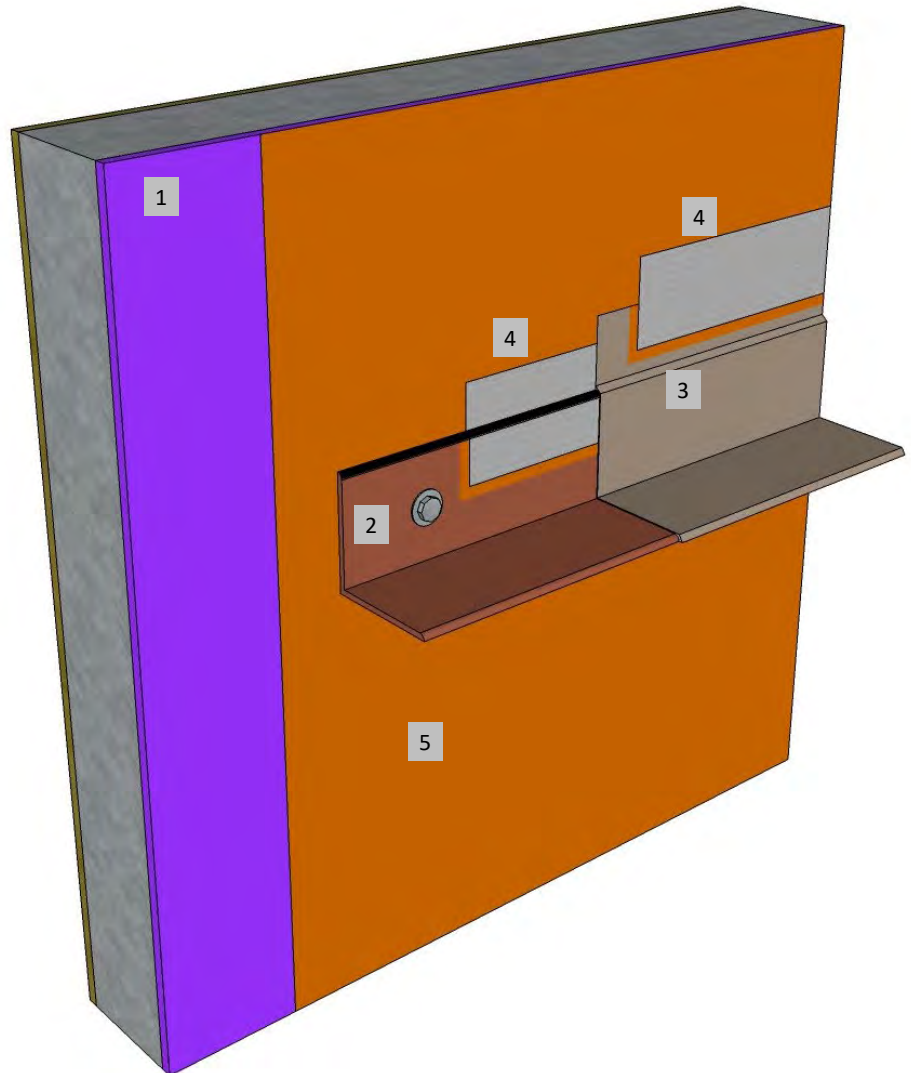

1. FRAMING & APPROVED SUBSTRATE
2. SHELF ANGLE
3. FLASHING
4. SUPERIORSHIELD FLASHING TAPE SET IN WET ROLLERSHIELD  
(ALTERNATE SUPERIORFLASH)
5. ROLLERSHIELD AIR/WATER BARRIER

**RSLAB-21 STRUCTURAL ANGLE**

**M Master Wall Inc.®**  
Building a Culture of Excellence

PO Box 397 · Fortson · GA · 31808 · 800-755-0825 · masterwall.com

These drawings relay the conceptual conditions of Master Wall® Systems and are not the construction drawings. Ultimately the design and detailing of an entire wall system is the responsibility of a professional. These details will guide the design professional in the use of Master Wall® Products. Master Wall disclaims design, warranty or construction intent or responsibility. Bold or Brand Name = Master Wall® Product. ©2025 Master Wall Inc.®



**Master Wall Inc.®**  
Building a Culture of Excellence

ROLLERSHIELD LAB

SYSTEM DETAIL

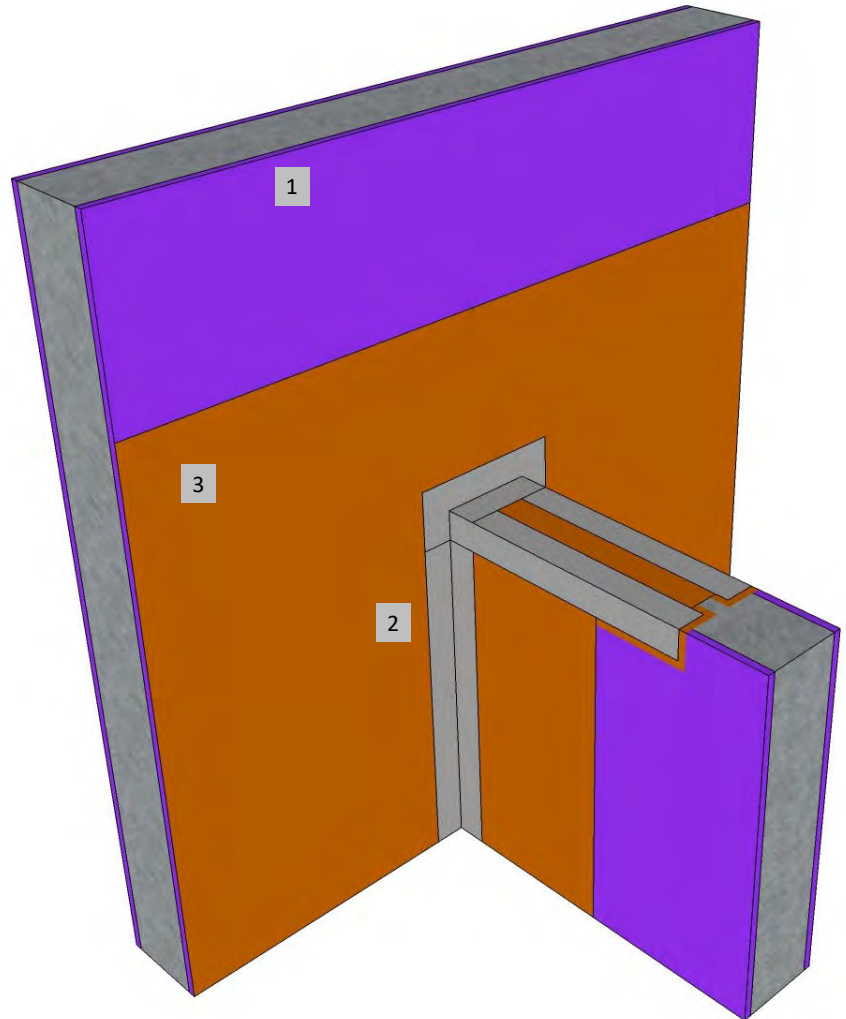
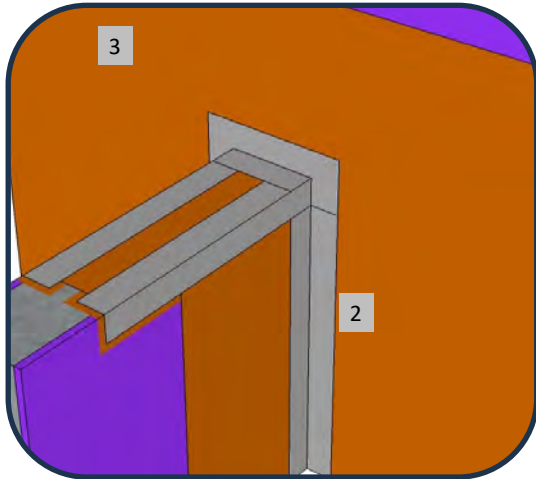

1. FRAMING & APPROVED SUBSTRATE
2. SUPERIORSHIELD FLASHING TAPE SET IN WET ROLLERSHIELD (ALTERNATE SUPERIORFLASH)
3. ROLLERSHIELD AIR/WATER BARRIER

**RSLAB-22 SADDLE WALL**

**M Master Wall Inc.®**  
Building a Culture of Excellence

PO Box 397 · Fortson · GA · 31808 · 800-755-0825 · masterwall.com

These drawings relay the conceptual conditions of Master Wall® Systems and are not the construction drawings. Ultimately the design and detailing of an entire wall system is the responsibility of a professional. These details will guide the design professional in the use of Master Wall® Products. Master Wall disclaims design, warranty or construction intent or responsibility. Bold or Brand Name = Master Wall® Product. ©2025 Master Wall Inc.®



**Master Wall Inc.®**  
Building a Culture of Excellence

ROLLERSHIELD LAB

SYSTEM DETAIL

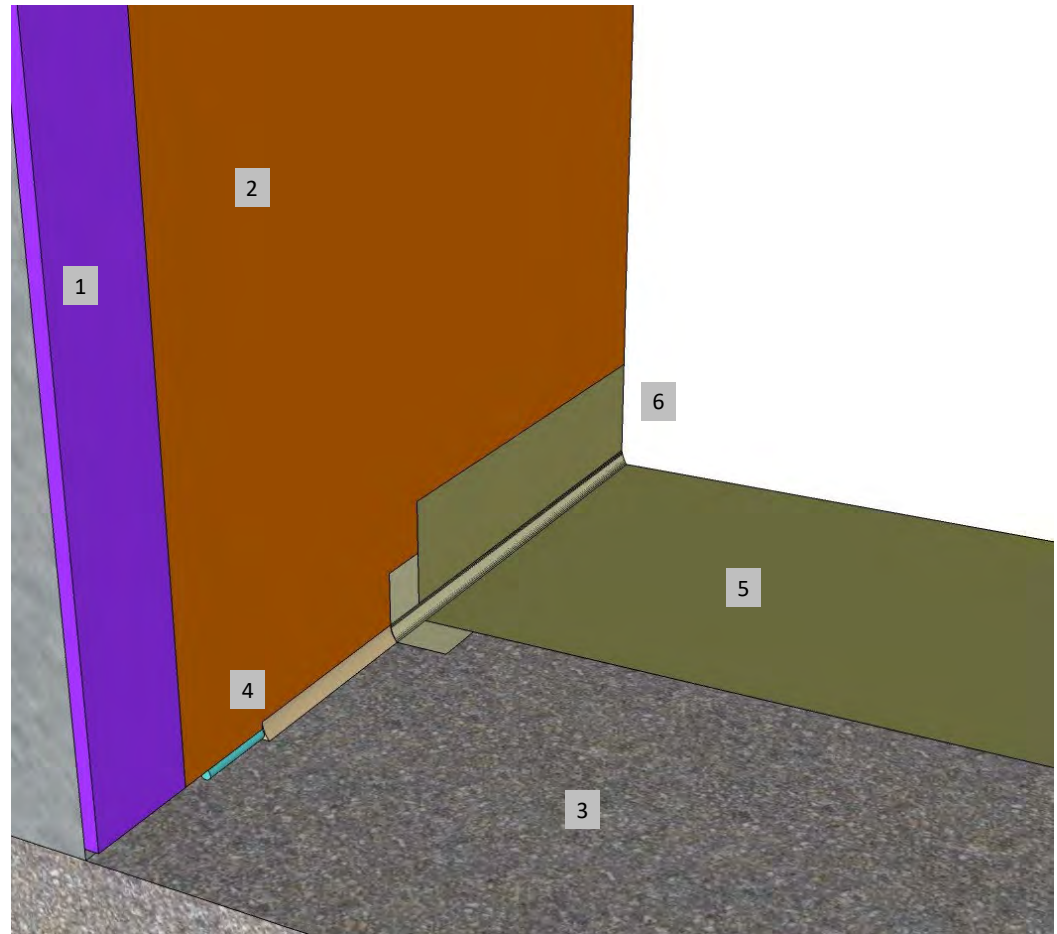

1. FRAMING & APPROVED SUBSTRATE
2. **ROLLERSHIELD AIR/WATER BARRIER**
3. CONCRETE SUBSTRATE
4. TOPPING MANUFACTURER APPROVED SEALANT AND BACKER ROD (DESIGNS VARY)
5. COMPATIBLE WATERPROOF TOPPING
6. EXTEND TOPPING 4" (102 MM) MIN. UP WALL

**RSLAB-23 DECK TERMINATION**

**M Master Wall Inc.®**  
Building a Culture of Excellence

PO Box 397 · Fortson · GA · 31808 · 800-755-0825 · masterwall.com

These drawings relay the conceptual conditions of Master Wall® Systems and are not the construction drawings. Ultimately the design and detailing of an entire wall system is the responsibility of a professional. These details will guide the design professional in the use of Master Wall® Products. Master Wall disclaims design, warranty or construction intent or responsibility. Bold or Brand Name = Master Wall® Product. ©2025 Master Wall Inc.®



**Master Wall Inc.**  
Building a Culture of Excellence

ROLLERSHIELD LAB

SYSTEM DETAIL



1. FRAMING & APPROVED SUBSTRATE
2. ROLLERSHIELD AIR/WATER BARRIER
3. SUPERIORSHIELD FLASHING TAPE SET IN WET ROLLERSHIELD (ALTERNATE SUPERIORFLASH)
4. WEATHERSTOP TAPE
5. SHEET WATER BARRIER

**RSLAB-24 TRANSITION TO SHEET WATER BARRIER**

**M Master Wall Inc.**  
Building a Culture of Excellence

PO Box 397 · Fortson · GA · 31808 · 800-755-0825 · masterwall.com

These drawings relay the conceptual conditions of Master Wall® Systems and are not the construction drawings. Ultimately the design and detailing of an entire wall system is the responsibility of a professional. These details will guide the design professional in the use of Master Wall® Products. Master Wall disclaims design, warranty or construction intent or responsibility. Bold or Brand Name = Master Wall® Product. ©2025 Master Wall Inc.®



**Master Wall Inc.**  
Building a Culture of Excellence

ROLLERSHIELD LAB

SYSTEM DETAIL

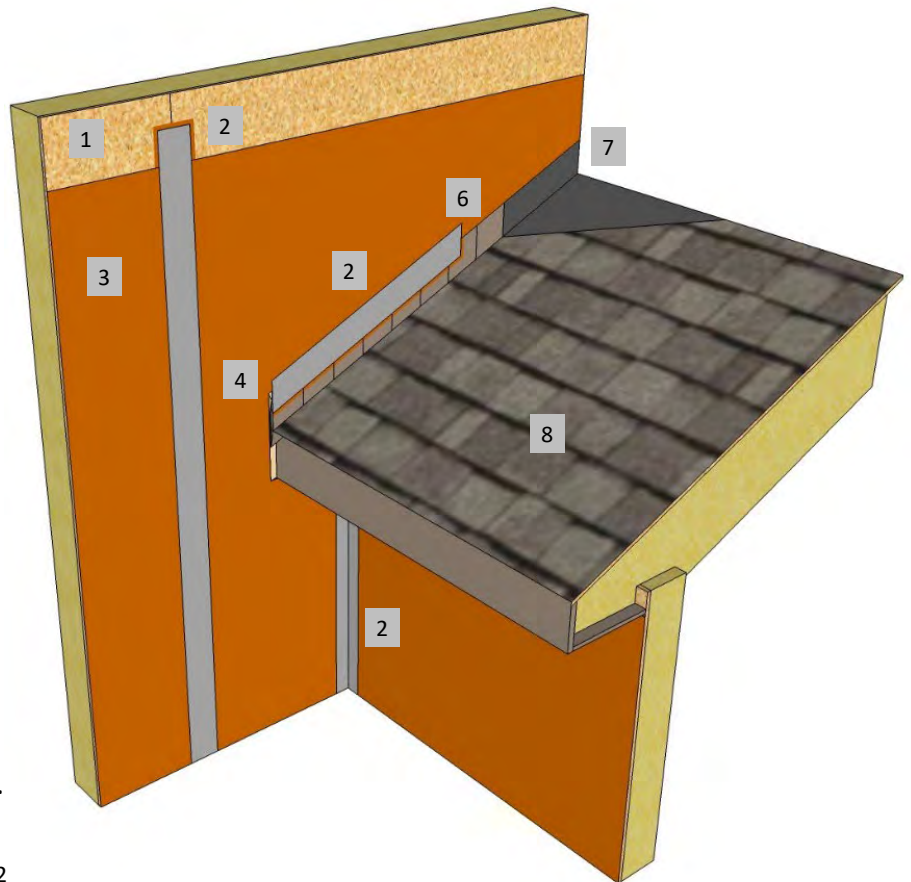
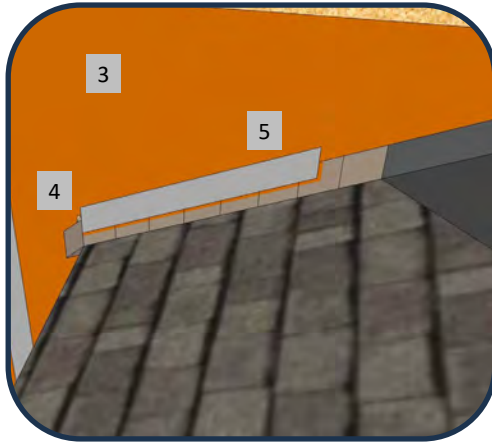

1. FRAMING & APPROVED SUBSTRATE
2. SUPERIORSHIELD FLASHING TAPE SET IN WET ROLLERSHIELD (ALTERNATE SUPERIORFLASH)
3. ROLLERSHIELD AIR/WATER BARRIER
4. KICK OUT FLASHING ANGLE KICK-OUT FLASHING 100° MINIMUM TO ALLOW FOR DRAINAGE. KICK OUT FLASHING SEAMS MUST BE SOLDERED OR SEALED WITH APPROPRIATE SEALANT
5. ROLLERSHIELD SHOULD COVER THE STEP FLASHING A MINIMUM OF 2" (51 MM) AND SIDING SHOULD BE PLACED ABOUT 1" TO 2" (25-51 MM) ABOVE THE ROOFLINE IN ACCORDANCE WITH LOCAL REQUIREMENTS.
6. ROOF STEP FLASHING, EXTEND UP SIDEWALL 4" (102 MM) MIN.
7. ROOFING FELT, EXTEND UP SIDEWALL 4" (102 MM) MIN.
8. ROOF SYSTEM: ROOF SHINGLES (07300), ROOF FELT TURNED UP WALL 4" (102 MM) MIN, ROOF STEP FLASHING AND DRIP EDGE

### **RSLAB-25 TYPICAL ROOF/WALL INTERSECTION**

**M Master Wall Inc.**  
Building a Culture of Excellence

PO Box 397 · Fortson · GA · 31808 · 800-755-0825 · masterwall.com

These drawings relay the conceptual conditions of Master Wall® Systems and are not the construction drawings. Ultimately the design and detailing of an entire wall system is the responsibility of a professional. These details will guide the design professional in the use of Master Wall® Products. Master Wall disclaims design, warranty or construction intent or responsibility. Bold or Brand Name = Master Wall® Product. ©2025 Master Wall Inc.®



**Master Wall Inc.®**  
Building a Culture of Excellence

ROLLERSHIELD LAB

SYSTEM DETAIL

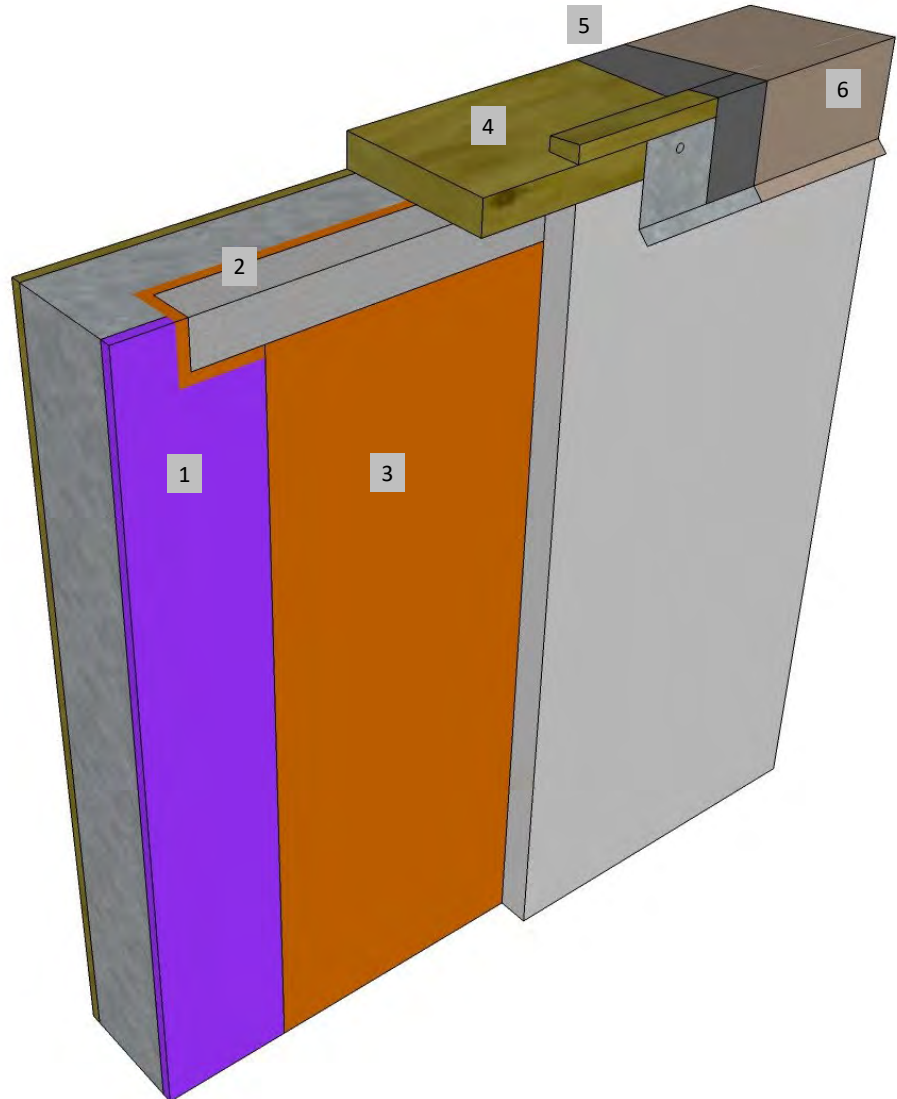

1. FRAMING & APPROVED SUBSTRATE
2. SUPERIORSHIELD FLASHING TAPE SET IN WET ROLLERSHIELD (ALTERNATE SUPERIORFLASH)
3. ROLLERSHIELD AIR/WATER BARRIER
4. TREATED NAILER
5. ROOFING – EXTEND OVER CONTINUOUS CLEAT
6. COPING CAP WITH CONTINUOUS CLEAT – EXTEND 2” (51 MM) MIN OVER EIFS AND STUCCO AND SEAL LOWER EDGE. FOLLOW MANUFACTURER’S RECOMMENDATIONS FOR OTHER SIDING MATERIALS

**RSLAB-26 ROOF CAP**

**M Master Wall Inc.®**  
Building a Culture of Excellence

PO Box 397 · Fortson · GA · 31808 · 800-755-0825 · masterwall.com

These drawings relay the conceptual conditions of Master Wall® Systems and are not the construction drawings. Ultimately the design and detailing of an entire wall system is the responsibility of a professional. These details will guide the design professional in the use of Master Wall® Products. Master Wall disclaims design, warranty or construction intent or responsibility. Bold or Brand Name = Master Wall® Product. ©2025 Master Wall Inc.®